

GEOline®

by Tecomec

TECHNOLOGICAL PROGRESS IN AGRICULTURE



AGRICULTURAL
SPRAY
PRODUCTS

CATALOGUE **2020**

ITA-ENG-RUS
A01

1	Sistemi di controllo Control systems Системы контроля	Page 2
1A	Gruppi di comando Control units Блоки управления	Page 64
2	Valvole a sfera Ball valves Шаровые краны	Page 142
3	Filtri di aspirazione e mandata Suction and line filters Всасывающие и напорные фильтры	Page 160
4	Raccorderia in polipropilene Polypropylene fittings Полипропиленовые фитинги	Page 194
5	Articoli per immissione liquidi e di completamento cisterne Basket filters, tank lids and accessories Аксессуары для емкостей	Page 214
6	Ugelli e portaugelli Nozzles and nozzle holders Форсунки и форсункодержатели	Page 238
6A	Barre da diserbo Vineyard spray booms Штанги опрыскивателей	Page 298
7	Accessori irrorazione Sprayer accessories Аксессуары для опрыскивателей	Page 308

LEGENDA

Campo di impiego / Use / Применение



Per macchine a basso volume
For low-volume spraying machines
Для малообъемных опрыскивателей



Per atomizzatori
For orchard sprayers
Для опрыскивателей



Per macchine da diserbo
For crop sprayers
Для штанговых опрыскивателей



Sistema di comando senza fili
Wireless control system
Беспроводная система управления



Adatto per distributori olio idraulico
Suitable to hydraulic oil distributors
Пригодно для распределителей гидр.масла

Caratteristiche / Features / Характеристики



Temperatura max
Max temperature
Максимальная температура



Tensione di alimentazione
Working voltage
Напряжение питания



Assorbimento elettrico
Power consumption
Электропотребление



Accessori da ordinare separatamente *Accessories to be ordered separately* Заказываемые отдельно аксессуары



Portagomma di entrata valvole generali
Inlet hoses for main valves
Входной штуцер для главных клапанов



Portagomma di uscita valvole di sezione
Outlet hoses for section valves
Выходной штуцер для секционных клапанов



Portagomma by-pass valvola generale
Hoses by-pass for main valves
Байпасный штуцер для главных клапанов



Flange / Portagomma per valvole elettriche
Adapters / Hoses for electric valves
Фланцы / штуцеры для электрических клапанов

Accessori opzionali *Optionals* Дополнительные аксессуары



Flussometro
Flowmeter
Расходомер



Sensore di pressione
Pressure sensor
Датчик давления



Sensore di livello
Level sensor
Уровневый датчик



Cavo collegamento
Connecting cable
Соединительный кабель



Prolunga per cavo collegamento
Extension for connecting cable
Удлинитель соединительного кабеля



Antenna GPS
GPS antenna
Антенна GPS



Supporto di fissaggio
Fixing support
Крепежный суппорт

SISTEMI DI CONTROLLO 1

CONTROL SYSTEMS / СИСТЕМЫ КОНТРОЛЯ

Sistemi di controllo

Questi dispositivi consentono la gestione ed il controllo dei parametri di trattamento alle colture. I sistemi di controllo Geoline sono di rapida installazione su ogni tipo di macchina operatrice del settore, garantiscono precisione ed efficienza nel lavoro e sono di facile utilizzo. La gamma è composta da: Computer GeoSystem, Visualizzatori GeoSystem, Scatole di comando elettriche, Radiocomandi, Accessori di completamento.

Control Units

These systems are our best solution for controlling and operating the working parameters. They are easy to fit and are adaptable to all working requirements of the machines on which they are installed. They allow the optimization of the treatment precisely and they are easy to use as well. The range of these systems is composed of the following parts: Geosystem Computer, Geosystem Display, Electric Driver Box, Radio remote controls, Optionals.

Системы контроля

Данные устройства обеспечивают управление и контроль параметров обработки. Системы контроля Geoline быстро устанавливаются на любых видах машин, гарантируют точность и рабочую эффективность, удобны в использовании. Гамма включает следующее оборудование: компьютер GeoSystem, дисплеи GeoSystem, электрические блоки управления, системы радиуправления, дополнительные аксессуары.



Global Navigation Satellite Systems

CON GEONAVE LE LAVORAZIONI IN CAMPO SONO MOLTO PIÙ SEMPLICI!

GeoNave è un utile supporto in tutte le attività come la coltivazione, l'aratura, la semina, l'irrorazione e la raccolta. Una piattaforma snella che offre i migliori risultati con costi di esercizio inferiori!

FACILE DA INSTALLARE, CONFIGURARE E UTILIZZARE

GeoNave è un sistema di navigazione GPS: consente, infatti, di controllare il percorso della macchina nell'area di lavoro, tracciando linee parallele rette o curve, impostando un punto di partenza (A) e un punto di arrivo (B).

POSSIBILITÀ DI IMPORTARE ED ESPORTARE MAPPE DI PRESCRIZIONE.

DISPOSITIVO COMPATTO- Ingombri ridotti in cabina

RISPARMIO DI TEMPO - Consente di riprendere facilmente lavorazioni precedenti

ELEVATA PRODUTTIVITÀ - evita le sovrapposizioni ed aiuta l'operatore soprattutto in tutte le fasi di manovra

RIDOTTO IMPATTO AMBIENTALE - Fino al 20% in meno di prodotti distribuiti

THE MOST COMMON TASKS IN THE CROP WITH GEONAVE ARE MUCH EASIER!

GeoNave allows many crop tasks to be carried out, such as tillage, seeding, planting, spraying and harvesting. A lean platform, delivering the best results with the lower tunning cost!

EASY TO INSTALL, SETUP & OPERATE
Geonave acts as a virtual guide, it allows you to control the pathway of the machine in the growing area, navigating in parallel and evenly spaced lines, regardless of whether the track follows a straight line or a curve, requiring only a starting point (A) and an ending point (B).

THE ABILITY TO IMPORT AND EXPORT MAPS.

SINGLE DEVICE - Clutter-free cabin

SAVES YOU TIME - Easily recover your previous jobs

HIGH PRODUCTIVITY - Overlapping and failure prevention

ENVIRONMENTALLY FRIENDLY - Up to 20% less applied inputs

ВЫПОЛНЕНИЕ НАИБОЛЕЕ РАСПРОСТРАНЕННЫХ ЗАДАЧ ПРИ ОБРАБОТКЕ СЕЛЬСКОХОЗЯЙСТВЕННЫХ КУЛЬТУР С GEONAVE СТАНОВИТСЯ НАМНОГО ПРОЩЕ!

GeoNave выступает в качестве виртуального проводника, позволяет контролировать маршрут машины на обрабатываемом участке, с навигацией между параллельными и равномерно расположенными рядами, в независимости, если трактор идет по прямой или криволинейной траектории, требует только одной начальной и одной конечной точки.

ПРОСТОЙ В УСТАНОВКЕ, НАСТРОЙКЕ И ИСПОЛЬЗОВАНИИ

GeoNave выполняет множество задач, связанных с сельскохозяйственными культурами, например, почвообработка, посев, посадка, опрыскивание и сбор. Гибкая платформа, обеспечивающая оптимальные результаты при меньших затратах управления!

ВОЗМОЖНОСТЬ ИМПОРТИРОВАТЬ И ЭКСПОРТИРОВАТЬ КАРТЫ

ОДНОУСТРОЙСТВО - Оптимизированное пространство в кабине
ЭКОНОМИЯ ВРЕМЕНИ - Удобное восстановление предыдущих заданий
ВЫСОКАЯ ПРОИЗВОДИТЕЛЬНОСТЬ - Предупреждение повторного прохождения участков и сбояв
ЭКОЛОГИЧНОСТЬ - Уменьшение до 20% применяемых ресурсов

Pattern

STRAIGHT LINE

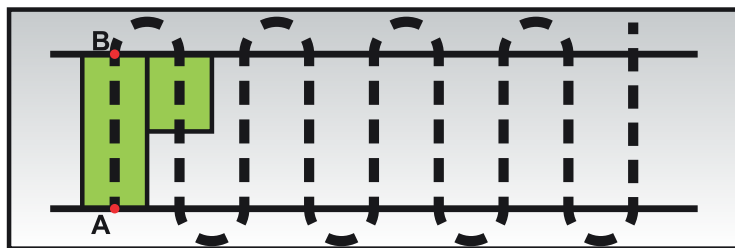

Pattern

CURVED LINE

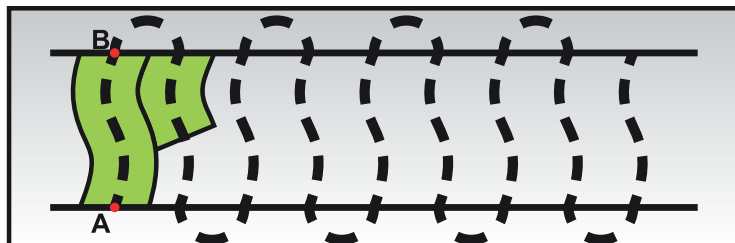

Global Navigation Satellite Systems

L'utilizzo di tecnologie di navigazione satellitare (GNSS) in agricoltura può aiutare l'operatore nello svolgimento delle attività agricole meccanizzate, facendo risparmiare tempo e danaro.

I sistemi GNSS indicano all'operatore il percorso da seguire ottimizzando la resa, evitando di lavorare o trattare due volte la stessa area. Una visualizzazione globale del campo che si sta lavorando, garantisce un perfetto controllo dell'attività che si sta svolgendo. Report finali del lavoro eseguito consentono di gestire i costi di lavorazione del terreno.

“Barra di luce” e indicazioni numeriche consentono all'operatore di muoversi con l'attrezzatura, seguendo linee parallele con grande facilità. L'operatore non necessita di sistemi meccanici o schiumogeni per tracciare le aree già lavorate. Tutte le attività sono ben rappresentate sul monitor del navigatore, che garantisce un assoluto miglioramento in termini di precisione.

Le attività notturne sono semplificate, il navigatore fornisce indicazioni chiare sulla posizione e sulla direzione, anche in caso di scarsa visibilità. GeoNave è compatibile con 5 costellazioni di satelliti dedicati alla funzione GNSS: GPS (US), GLONASS (Russia), GALILEO (EU), BEIDOU (China), e QZSS (Japan).

- Guida per linee rette parallele
- Guida per linee curve parallele
- Regolazione della dose
- Chiusura automatica delle sezioni in caso di sovrapposizione (Automatic Section Control - ASC)
- Misura del perimetro e della superficie lavorata
- Memorizzazione dei dati delle lavorazioni effettuate

GeoNave fornisce un alto livello di precisione ideale per tutte le condizioni di lavoro.

The application of Global Navigation Satellite Systems (GNSS) technology to agriculture can help the operator carry out the most complex and costly agricultural activities, saving time and money. The GNSS systems indicate to the operator the paths to follow, optimizing the tillage, avoiding the same activity to be performed twice (fertilizing or spraying, sowing etc.) on the same surface. A map of the field clearly visible on the monitor guarantees a global view of the activity that is taking place. It also helps prevent yield loss due to row deviation. And end of work reports can help keeping costs low, with daily activities under control.

Light bars and numerical indications make it possible to keep the tractor and its implement on parallel paths with great ease. The operator does not need mechanical or foam track-files that require activation or maintenance at every change of direction. All activities are done faster, also guaranteeing an absolute improvement on the work performed in terms of precision. Even night-time activities are supported by GNSS, giving precise instructions to the operator who does not have perfect visibility due to poor lighting conditions.

- Straight parallel guide
- Guide on curvilinear trajectories
- Control of the delivered dose (Sprayer)
- Automatic section closure in case of overlap (Automatic section control)
- Perimeter and field area measurement
- Database of fields and tasks

GeoNave provides a high level of precision suitable for all working conditions.

Использование технологий спутниковой системы навигации (GNSS) в сфере сельского хозяйства может помочь оператору при выполнении механизированных сельскохозяйственных работ, с экономией времени и денежных средств. Системы GNSS указывают оператору следующий маршрут с оптимизацией результата, избегая повторной обработки одного и того же участка. Карта обрабатываемого участка гарантирует глобальное видение выполняемых работ. Итоговые отчеты выполненной работы позволяют держать под контролем расходы, связанные с обработкой земельного участка.

Световая штанга и цифровые указания позволяют оператору легко следить за параллельными рядами. Оператор не нуждается в механических системах или пене для обозначения обработанных участков. Все работы являются четкими, хорошо представленными на дисплее, что гарантирует абсолютное улучшение уровня точности выполняемой работы.

Работа в ночное время упрощена, навигатор предоставляет четкие указания о положении и направлении, в том числе в случае плохой видимости.

- Управление на параллельных рядах
- Управление на криволинейных траекториях
- Контроль дозирования
- Автоматический контроль секций (ASC) в случае наложения (Automatic Section Control ASC)
- Измерение периметра и обработанной площади
- Реестратор полей и выполненной работы

GeoNave обеспечивает высокий уровень точности, соответствующий всем рабочим условиям.

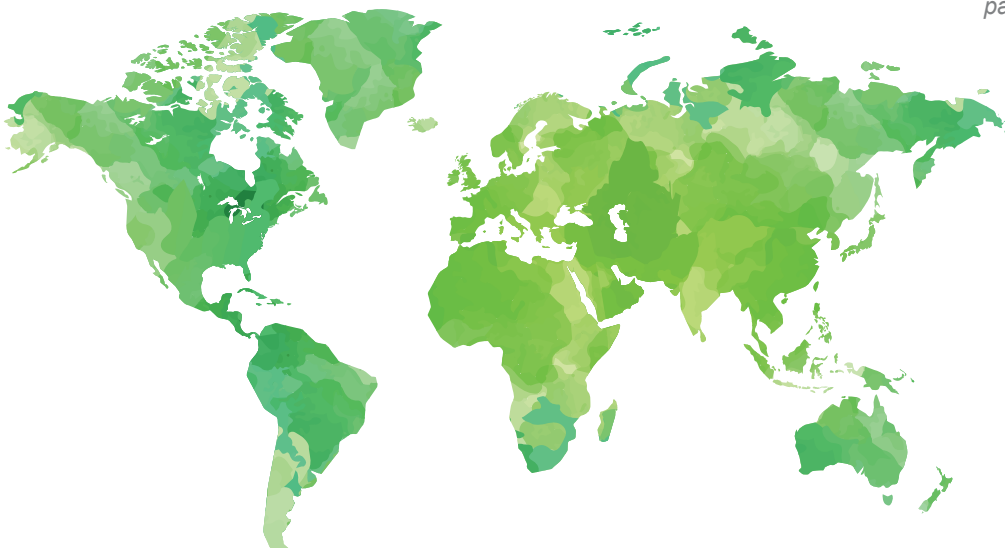

WORLDWIDE COVERAGE

GNSS GPS/GLONASS
ON DEMAND WITH SOFTWARE UPGRADE
GALILEO (EU), BEIDU (CH)

GeoNave



POSITIONING ACCURACY

GNSS L1 GPS/GLONASS pass to pass 30 cm

ON DEMAND with software and hardware upgrade

GNSS L1/L2 GPS/GLONASS pass to pass 15 cm

GNSS L1/L2/LBAND GPS/GLONASS/TERRASTAR pass to pass 2,5 cm

GNSS L1/L2/RTK GPS/GLONASS/RTK absolute 2 cm

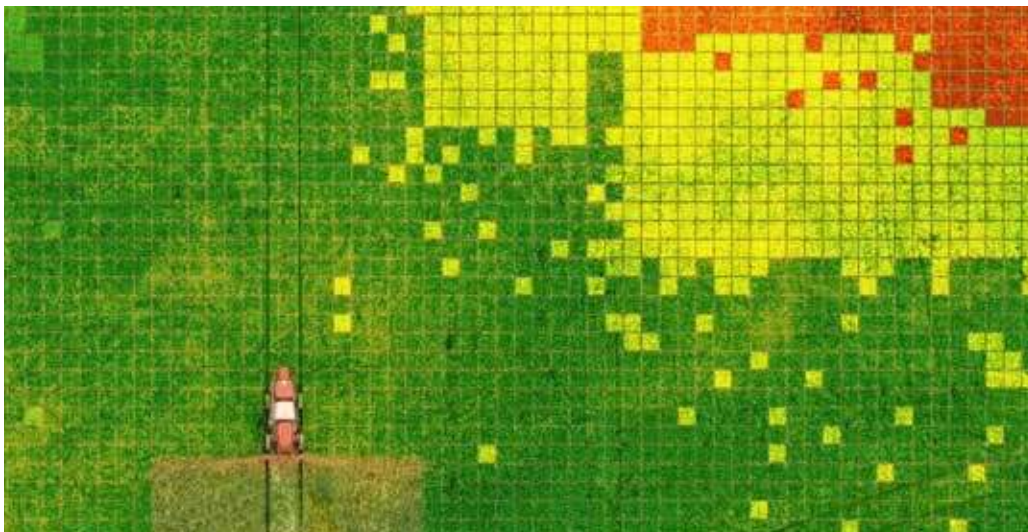

GeoNave

GEONAVE

GeoNave permette di seguire percorsi di lavoro basati su linee parallele rette o curve. Richiede solo un punto di partenza (A) ed un punto di arrivo (B).

GeoNave assiste l'operatore nell'esecuzione di moltissime attività in campo: semina, irrorazione e raccolta. Una piattaforma efficace, che offre i migliori risultati con il minor costo di gestione!

TRATTAMENTO DEL RACCOLTO PRE E POST EMERGENZA

L'APPLICAZIONE DI PRODOTTI CHIMICI È UNO DEI PASSAGGI PIÙ CRITICI NELLA CURA DI UNA COLTURA. GEONAVE FORNISCE ALL'OPERATORE LA TECNOLOGIA DI PILOTAGGIO, PER UN'APPLICAZIONE PIÙ ACCURATA IN TUTTE LE CONDIZIONI DI OPERATIVITÀ.

GeoNave funge da controller dell'irrorazione, regolando le dosi d'applicazione in base alla mappa di prescrizione caricata nella sua memoria interna, oppure può essere gestito direttamente dall'operatore.

GeoNave può essere utilizzato in vari tipi di irroratori: semoventi, trainati o portati, predisposti con flussometro, valvola di regolazione, valvola generale e fino a 9 sezioni. Se utilizzato congiuntamente alla funzionalità di controllo automatico delle sezioni (ASC), il sistema impedisce la sovrapposizione delle aree già trattate.

È possibile attuare un controllo completo delle macchine irroratrici senza l'aggiunta di componenti esterni o altri dispositivi.

GeoNave aumenta ulteriormente i risparmi con la funzionalità di controllo automatico delle sezioni (ASC). Assicura la qualità del lavoro dell'operatore e a salvaguardia dell'ambiente, poiché il sistema GPS aiuta ad evitare gli sprechi. GeoNave controlla le valvole, aprendo e chiudendo automaticamente le sezioni di barra in caso di sovrapposizione. I risparmi iniziano dal primo giorno di utilizzo e continuano a lungo, riducendo il costo complessivo di ogni coltivazione!

GEONAVE

GeoNave acts as a virtual guide, it allows you to control the pathway of the machine in the growing area, navigating in parallel and evenly spaced lines, regardless of whether the track follows a straight line or a curve, requiring only a starting point and an ending point. GeoNave allows many crop tasks to be carried out, such as tillage, seeding, planting, spraying and harvesting. A lean platform, delivering the best results with the lower running cost!

SPRAYING PRE- AND POST-EMERGENT CROPS

THE SPRAY APPLICATION IS ONE OF THE MOST CRITICAL STEPS IN THE GROWING OF A CROP. GEONAVE ADDS TOP-TIER TECHNOLOGY TO THE CABIN, PROVIDING A MORE ACCURATE APPLICATION WITH INTEGRATED CONTROL.

GeoNave acts as the sprayer controller, regulating the flow rate of liquid inputs according to the preset dosing map loaded in its memory, or it can follow a fixed value set by the operator himself.

GeoNave can be used in various types of sprayers: self-propelled, pull-type or mounted, set up with flow meter, regulating valve, general valve and up to 9 section valves (2 or 3 wires). When used jointly with the automatic section controller functionality, the system prevents overlapping of applied areas. All settings are possible to be set in an integrated manner, without the addition of external components or extra devices.

GeoNave further increase savings with the automatic section controller functionality. Get assured of the quality of the operator's work, as the GPS system ensures that there is no input waste. GeoNave commands the valvetrain, automatically opening and closing the sections. The savings start from day one of use, and go on and on, reducing the overall cost of every crop!

GEONAVE

GeoNave permette di seguire percorsi di lavoro basati su linee parallele rette o curve. Richiede solo un punto di partenza (A) ed un punto di arrivo (B).

GeoNave assiste l'operatore nell'esecuzione di moltissime attività in campo: semina, irrorazione e raccolta. Una piattaforma efficace, che offre i migliori risultati con il minor costo di gestione!

OBBLIGO DI TRATTAMENTO PRE E POST EMERGENZA

L'APPLICAZIONE DI PRODOTTI CHIMICI È UNO DEI PASSAGGI PIÙ CRITICI NELLA CURA DI UNA COLTURA. GEONAVE FORNISCE ALL'OPERATORE LA TECNOLOGIA DI PILOTAGGIO, PER UN'APPLICAZIONE PIÙ ACCURATA IN TUTTE LE CONDIZIONI DI OPERATIVITÀ.

GeoNave funge da controller dell'irrorazione, regolando le dosi d'applicazione in base alla mappa di prescrizione caricata nella sua memoria interna, oppure può essere gestito direttamente dall'operatore.

GeoNave può essere utilizzato in vari tipi di irroratori: semoventi, trainati o portati, predisposti con flussometro, valvola di regolazione, valvola generale e fino a 9 sezioni. Se utilizzato congiuntamente alla funzionalità di controllo automatico delle sezioni (ASC), il sistema impedisce la sovrapposizione delle aree già trattate.

È possibile attuare un controllo completo delle macchine irroratrici senza l'aggiunta di componenti esterni o altri dispositivi.

GeoNave aumenta ulteriormente i risparmi con la funzionalità di controllo automatico delle sezioni (ASC). Assicura la qualità del lavoro dell'operatore e a salvaguardia dell'ambiente, poiché il sistema GPS aiuta ad evitare gli sprechi. GeoNave controlla le valvole, aprendo e chiudendo automaticamente le sezioni di barra in caso di sovrapposizione. I risparmi iniziano dal primo giorno di utilizzo e continuano a lungo, riducendo il costo complessivo di ogni coltivazione!

GeoNave 31



Pag. 8

GeoNave 30



Pag. 10

GeoNave 31



REGOLATORE DI DOSE GPS

- Variazione automatica del flusso in base alla velocità di avanzamento;
- Regolazione del flusso in base al dosaggio stabilito dall'utente;
- Dose variabile in base a mappe di prescrizione;
- Gestione di valvole e ugelli di diversi tipi;
- Controllo di ogni singola valvola della barra;
- Chiusura automatica delle sezioni in base alla posizione GPS, per prevenire sovrapposizione di prodotto chimico.

SPRAYING CONTROLLER

- Flow calculation according to machine speed;
- Flow rate adjustment with preset fixed dosage;
- Variable dosage application map processing;
- Proportional control of flow through regulating valve;
- Setup of different types of valves and nozzles;
- Spraying section shutoff valve control;
- Automatic section shutoff to avoid overlay.

РЕГУЛЯТОР ДОЗИРОВКИ GPS

- Автоматическое изменение потока в соответствии со скоростью движения
- Регулирование потока в соответствии с установленной пользователем дозировкой
- Изменяемая дозировка в соответствии со схемами обработки
- Управление различными клапанами и форсунками
- Контроль каждого отдельного клапана секции
- Автоматическое закрытие секций, в зависимости от положения GPS, для предупреждения повторного разбрызгивания химического средства



Part No.	Section Valves (W)	Description	Pack
8410084	9	GeoNave 31	1

FEATURES

Display Dimension 152 x 91 mm	Display Resolution 800 x 480 pixel	Display Type TFT active matrix	Display Light RGB - stripe	USB plug ✓
Language PT-EN RU-CN	kg ~1,5	°C 20 +70	V dc 9,5 - 16	A 0,5 - 30
	Protection IP 65	case ABS		

DIMENSIONS

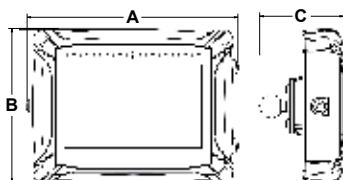

AxBxC mm
235,5x172,5x94

Campo di impiego / Use / Применение



Composizione del kit / Kit composed of / Комплектация



A Monitor Monitor Монитор	F Supporto magnetico per antenna Magnetic support for antenna магнитная опора для антенны	
B Antenna GPS GPS antenna Антенна GPS	G Cavo alimentazione monitor Monitor power cable монитор силовой кабель	L = 3,0 m
C Ventosa Suction cup Крепление присоска	H Cavo collegamento antenna Antenna connecting cable Антенный соединительный кабель	L = 6,0 m
D Supporto a sfera per fissaggio monitor Monitor holder with ball Шариковая опора для крепления монитора	I Cavo connessione batteria Battery connecting cable кабель для подключения аккумулятора	L = 1,4 m
E Supporto antenna Antenna support Антенная поддержка		



INSTALLATION

GeoNave 31

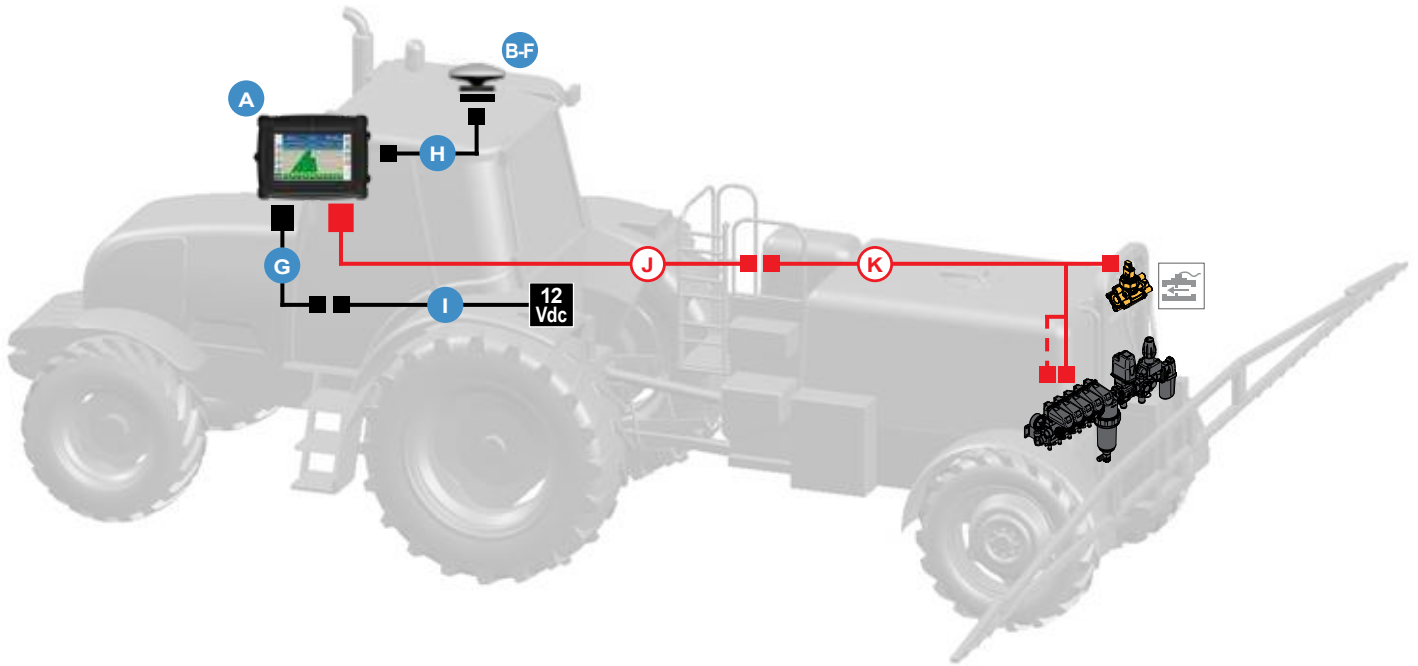

Obbligatorio ordinare separatamente.
Compulsory: to be ordered separately.
Обязательно: заказывать отдельно.

J  **Cavo collegamento monitor**
Monitor connecting cable
монитор соединительный кабель **Pag. 56**

K  **Cavo collegamento valvole**
Valves connecting cable
клапаны соединительный кабель **Pag. 56**

Automatic section shutoff to avoid overlay

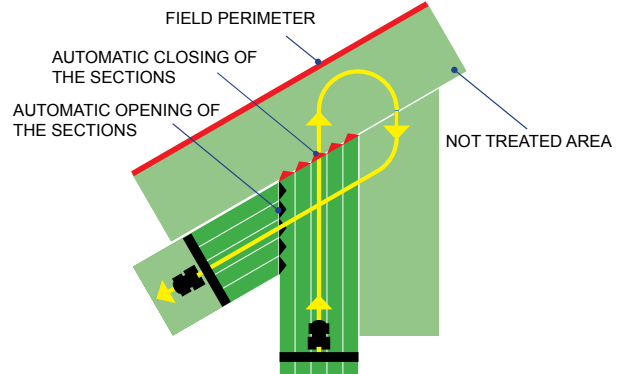

OPTIONALS

PAGE		PAGE	
115-120	Flussometro Flowmeter Расходомер	53	Staffa da palo con sfera (senza braccio di completamento) Pole bracket with ball (without supplementary arm) Кронштейн на опоре со сферой (без дополнительного рычага)
117	Sensore di flusso Flow sensor Датчик потока	54	Staffa da palo + Braccio + Supporto a sfera per fissaggio monitor Pole bracket + Arm + Monitor holder with ball Кронштейн на опоре + Рычаг + Суппорт со сферой для крепления дисплея
60	Cavo adattatore flussometro Flow meter adapter cable Кабель с адаптером расходомера	54	Braccio + Supporto a sfera per fissaggio monitor Arm + Monitor holder with ball Рычаг + Суппорт со сферой для крепления дисплея
53	Staffa ventosa con sfera + Supporto a sfera per fissaggio monitor Suction cup bracket with ball + Monitor holder with ball Кронштейн на присосе со сферой + Суппорт со сферой для крепления дисплея	54	Supporto a sfera per fissaggio monitor Monitor holder with ball Суппорт со сферой для крепления дисплея

Switch box on demand



Available on demand switch box for hydraulic cylinder
Available on demand switch box for section control

Electric steering wheel on demand



Available on demand kit to control electric steering wheel

GeoNave 30



SISTEMA DI NAVIGAZIONE GPS

- Navigazione per linee parallele: rette o curve;
- Facilità di uso in caso di interruzione o continuazione di una attività;
- Memorizzazione di percorso e mappa dell'area trattata;
- Calcolo dell'area coperta dalla lavorazione;
- Memorizzazione di velocità e tempo di attività effettuata;
- Importazione di percorsi e linee guida da progetto esterno;
- Memorizzazione ed esportazione verso altri sistemi di tutti i dati memorizzati.

VIRTUAL GUIDE

- Navigation in straight or curved parallel lines;
- Easily stop and resume activity;
- Recording of tracks and maps of traveled areas;
- Real-time calculation of machine-covered areas;
- Speed, distance and operating time recording;
- Importing guide project;
- Storage and downloading of all logged data.

СИСТЕМА НАВИГАЦИИ GPS

- Навигация для прямых или криволинейных параллельных линий;
- Простота использования в случае прерывания или возобновления работы;
- Сохранение маршрута и схемы обработанного участка;
- Расчет обрабатываемого участка;
- Сохранение скорости и времени выполняемой работы;
- Импорт маршрутов и инструкций из внешнего проекта;
- Сохранение и экспортирование на другие системы всех сохраненных данных.



Part No.	Description	Pack
8410083	GeoNave 30	1

FEATURES

Display Dimension 152 x 91 mm	Display Resolution 800 x 480 pixel	Display Type TFT active matrix	Display Light RGB - stripe	USB plug ✓
Language PT-EN RU-CN	kg ~1,5	°C 20 +70	V dc 9,5 - 16	A 0,5 - 30
			Protection IP 65	case ABS

DIMENSIONS

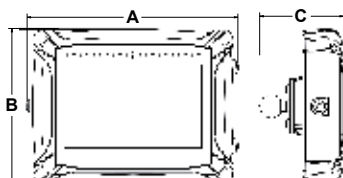

AxBxC mm
235,5x172,5x94

Campo di impiego / Use / Применение



Composizione del kit / Kit composed of / Комплектация



A Monitor Monitor Монитор	F Supporto magnetico per antenna Magnetic support for antenna магнитная опора для антенны	
B Antenna GPS GPS antenna Антенна GPS	G Cavo alimentazione monitor Monitor power cable монитор силовой кабель	L = 3,0 m
C Ventosa Suction cup Крепление присоска	H Cavo collegamento antenna Antenna connecting cable Антенный соединительный кабель	L = 6,0 m
D Supporto a sfera per fissaggio monitor Monitor holder with ball Шариковая опора для крепления монитора	I Cavo connessione batteria Battery connecting cable кабель для подключения аккумулятора	L = 1,4 m
E Supporto antenna Antenna support Антенная поддержка		



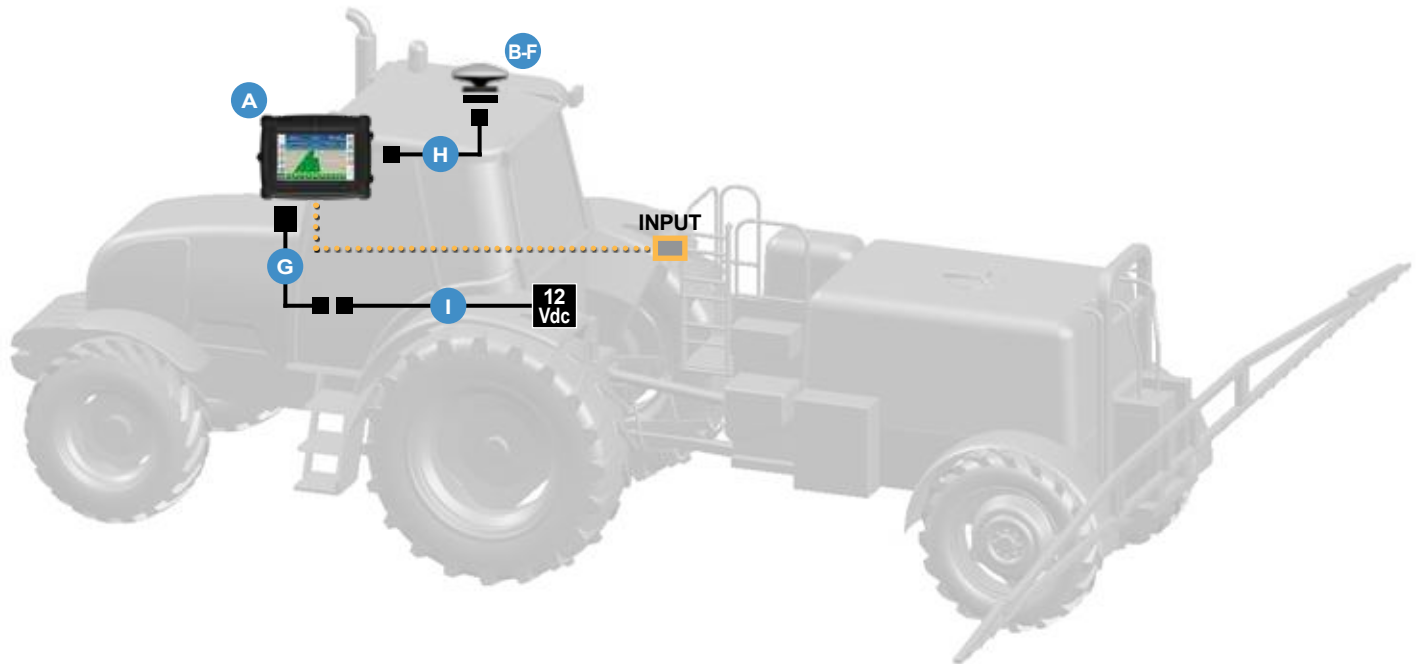

OPTIONALS

PAGE		PAGE	
115-120	Flussometro Flowmeter Расходомер	53	Staffa da palo con sfera (senza braccio di completamento) Pole bracket with ball (without supplementary arm) Кронштейн на опоре со сферой (без дополнительного рычага)
117	Sensore di flusso Flow sensor Датчик потока	54	Staffa da palo + Braccio + Supporto a sfera per fissaggio monitor Pole bracket + Arm + Monitor holder with ball Кронштейн на опоре + Рычаг + Суппорт со сферой для крепления дисплея
60	Cavo adattatore flussometro Flow meter adapter cable Кабель с адаптером расходомера	54	Braccio + Supporto a sfera per fissaggio monitor Arm + Monitor holder with ball Рычаг + Суппорт со сферой для крепления дисплея
53	Staffa ventosa con sfera + Supporto a sfera per fissaggio monitor Suction cup bracket with ball + Monitor holder with ball Кронштейн на присосе со сферой + Суппорт со сферой для крепления дисплея	54	Supporto a sfera per fissaggio monitor Monitor holder with ball Суппорт со сферой для крепления дисплея

ISOBUS SPRAYER ECU 1224



Electronic Control Unit compatible ISOBUS (ISO 11783 standard)

Caratteristiche:

- Unità di controllo elettronica (ECU) compatibile con lo standard ISO 11783 ISOBUS.
- Progettata per sprayer ed apparecchiature agricole con alto contenuto tecnologico
- Elimina sovrapposizioni durante la distribuzione di prodotto chimico, assicurando un alto grado di protezione al tuo raccolto. Il controllo automatico della dose mantiene costante ed uniforme la distribuzione del prodotto chimico. Compensa automaticamente le variazioni di velocità dello sprayer regolando il flusso di prodotto chimico in modo ottimale.

Possibilità di collegare e comandare una seconda ECU oleodinamica tramite Virtual Terminal

- Possibilità di collegare diversi sensori;
- 2 flussometri;
- 4 sensori ad ultrasuoni;
- 2 sensori di pressione/ livello.
- ISOBUS compatibile;
- Possibilità di comandare fino a 16 valvole di sezione;
- Possibilità di collegare due flussometri;
- 3 porte di comunicazione CAN.

Electronic Control Unit compatible ISOBUS (ISO 11783 standard)

Features:

- External Control Unit compatible ISOBUS (ISO 11783 standard).
- Designed for Sprayer, Spreader and generic agricultural application.
- Eliminates overlaps and reduces chemical usage assuring high protection at your crop. Ratio controller keeps constant and uniform chemical coverage on crop. Compensate speed variation regulating pressure in sprayer boom.

Ready to connect and operate through a virtual terminal a "slave" ECU for hydraulic cylinder

- Multiple sensors connectivity;
- 2 flowmeters;
- 4 ultrasonic sensors;
- 2 pressure/ level sensors.
- ISOBUS compatible;
- Up to 16 section valves, main valve, and regulation valve;
- Double Flowmeter;
- 3 CAN BUS communication ports;

Электронный блок управления, совместимый с ISOBUS (Стандарт ISO 11783)

Характеристики:

- Электронный блок управления (ЭБУ), совместимый со стандартом ISO 11783 ISOBUS.
- Предназначен для современной сельскохозяйственной техники
- Устраняет повторное прохождение участков и сокращает использование химических средств, с гарантией высокого уровня защиты сельскохозяйственных культур. Регулятор расхода поддерживает постоянное и равномерное распределение химического средства на сельскохозяйственную культуру. Компенсация изменения скорости с регулировкой давления в штанге опрыскивателя.
- Возможность подключения и управления вторым ЭБУ (который управляет гидроприводами) посредством Virtual Terminal
- Возможность подключения множества датчиков;
- 2 расходомера;
- 4 ультразвуковых датчика;
- 2 датчика давления / уровня.
- Совместимость ISOBUS;
- Возможность управления до 16 секционных клапанов;
- Возможность подключения двух расходомеров;
- 3 порта связи CAN.



Part No.	Section Valves (W)	Wires	Description	Pack
8410075	5	2	ECU 1224 5W	1
8410074	7	2	ECU 1224 7W	1
8410073	9	2	ECU 1224 9W	1

Section valves from 10 to 16 on demand

FEATURES

CPU	kg	°C	V dc	A	Protection	case
ARM® 32-bit Cortex®-M3 CPU (120 MHz max)	~1	-40 +85	9.5 - 32	14	IP 67	PA66 GF 30

DIMENSIONS

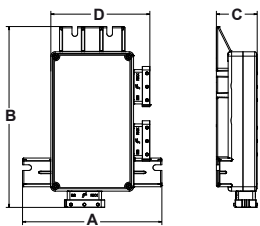

Ax BxCxD mm
160x208x47x114

Campo di impiego / Use / Применение



Composizione del kit / Kit composed of / Комплектация

SPARE PARTS Pag. 59-61

- A** Ecu
Ecu
Ecu
- U** Cavo collegamento valvole + sensore
Connecting cable for valves + sensors
Соединительный кабель клапанов + датчиков

- V** Cavo collegamento valvole + sensore
Connecting cable for valves + sensor
Соединительный кабель клапанов + датчиков



A



U



V

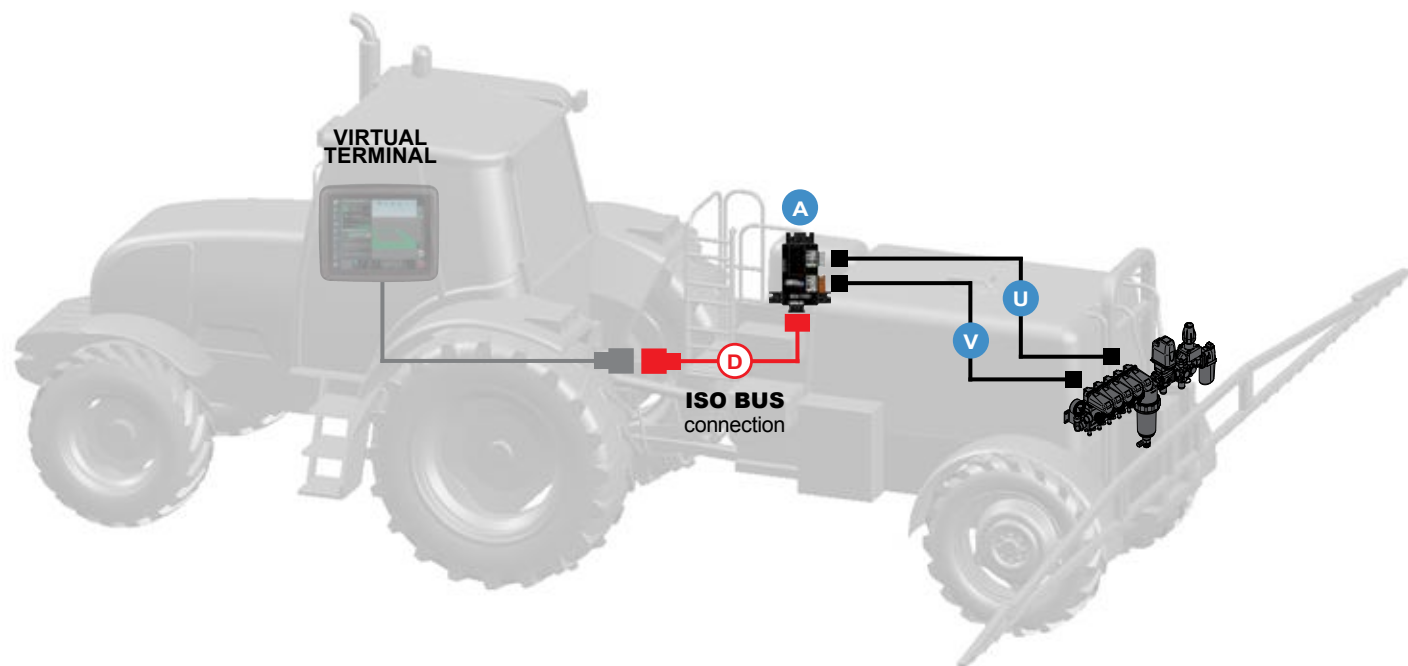

Obbligatorio ordinare separatamente.
Compulsory: to be ordered separately.
Обязательно: заказывать отдельно.

D  **Cavo connessione e alimentazione**
Feeding and connecting cable
Соединительный кабель и питания **Pag. 56**

ISOBUS è il termine con cui ci si riferisce alla norma ISO 11783 "trattori e macchine agricole e forestali".

Propone uno standard per il sistema di controllo e l'interfaccia uomo-macchina nei sistemi composti da trattore e attrezzi di lavoro, come ad esempio irroratrici, carri per il trasporto di prodotti agricoli, fertilizzazione ecc. ecc.. Prima dell'introduzione di ISOBUS, ogni attrezzo di lavoro era dotato di un proprio monitor di comando da collocare in cabina. Grazie alla tecnologia ISOBUS un unico terminale grafico chiamato "Virtual terminal" posizionato in cabina, ormai di serie su tutti i trattori più moderni, può controllare gli attrezzi ISOBUS compatibili. Può registrare dati di lavorazione, applicare dosi di fitofarmaci variabile in funzione di mappe di prescrizione utilizzando i dati provenienti dal sistema di navigazione (GPS)

ISOBUS is the term used to denote standard ISO 11783, "Tractors and machinery for agriculture and forestry".

It proposes a standard for the control system and man-machine interface for systems consisting of tractors and implements, such as spraying machines, wagons for the transportation of agricultural products, for fertilisation, etc.

Before the introduction of ISOBUS, every implement was equipped with its own control monitor, which had to be positioned in the cab.

Thanks to ISOBUS technology, a single graphical console called a "Virtual Terminal", located in the cab and now standard on all of the most modern tractors, can control any ISOBUS-compatible implement.

It can record data about production processes and apply varying doses of plant protection products based on prescription maps, using data from the navigation system (GPS).

ISOBUS - термин, соответствующий норме ISO 11783 "Тракторы и машины для сельского и лесного хозяйства".

Предлагает стандарт для системы контроля, а также интерфейса человек-машина в системах, состоящих из трактора и рабочих орудий, например, опрыскивателей, транспортных платформ сельскохозяйственных продуктов, удобрений и т.д.

До ввода ISOBUS каждое рабочее орудие было оснащено собственным размещаемым в кабине дисплеем управления.

Благодаря технологии ISOBUS, единый графический терминал, называемый "Virtual Terminal", размещаемый в кабине, предусмотренный теперь в стандартной комплектации на всех современных тракторах, может контролировать совместимые с ISOBUS орудия.

Может осуществлять регистрацию рабочих данных и применять различные дозы фитотоксикологических средств, в зависимости от предусмотренных схем, при использовании данных системы навигации (GPS).

OPTIONALS

PAGE			PAGE		
115-120	Flussometro <i>Flowmeter</i> <i>Расходомер</i>		48	Sensore di pressione <i>Pressure sensor</i> <i>Датчик давления</i>	50 bar 4-20 mA L = 5,0 m
117	Sensore di flusso <i>Flow sensor</i> <i>Датчик потока</i>		48	Sensore di pressione <i>Pressure sensor</i> <i>Датчик давления</i>	100 bar 4-20 mA L = 5,0 m
60	Cavo adattatore flussometro <i>Flow meter adapter cable</i> <i>Кабель с адаптером расходомера</i>	L = 0,5 m	48	Cavo adattatore sensore di pressione <i>Pressure sensor adapter cable</i> <i>Кабель с адаптером датчика давления</i>	L = 0,5 m
48	Sensore di pressione <i>Pressure sensor</i> <i>Датчик давления</i>	20 bar 4-20 mA L = 5,0 m	48	Sensore di livello completo di supporto per fissaggio <i>Level sensor complete with mounting bracket</i> <i>Уровневый датчик с монтажным кронштейном</i>	L = 0,5 m



GeoSystem 260

Computer per distribuzione di prodotti fitosanitari, adatto per macchine da diserbo, atomizzatori e multi-filari.

Caratteristiche:

- Versioni: fino a 7 valvole di sezione e 9 valvole idrauliche.
- Funzionamento automatico e manuale.
- Scatola di derivazione (Driver Box) a cablaggio semplificato di rapida installazione.
- Display grafico LCD retroilluminato di grandi dimensioni, leggibile in ogni condizione di luce.
- Possibilità di collegare il navigatore satellitare (opzionale) e di gestire in modo automatico la chiusura delle sezioni.
- Scambio dati e aggiornamento software tramite USB (standard)
- Scambio dati con FIELD Trace (opzionale).
- Compatibilità protocollo T.U.V.R. (Trimble®)
- Menu multilingua
- Inserimento semplificato dei parametri di lavoro
- Memorizzazione parametri di 8 ugelli personalizzati (in aggiunta agli ugelli ISO).
- Unità di misura configurabili: Metrico / US.
- Configurazione di 10 diversi tipi di trattamento.
- Allarmi visivi e sonori
- Strumento di diagnostica integrato
- Gestione tracciafile (solo per versione CS)
- Parametri gestiti: pressione, velocità, portata, area trattata, quantità distribuita, durata del trattamento, distanza percorsa, livello cisterna.

Computer for distributing phytosanitary products, suitable for weed-killing machines, sprayers and multi-row machines.

Features:

- Versions: up to 7 section valves and 9 hydraulic valves.
- Automatic and manual operation.
- Connecting box (Driver Box) with simplified, quick-to-install wiring.
- Large, rear-lit LCD graphic display, legible in all lighting conditions.
- Possibility to connect sat nav (optional) and automatically manage section closure.
- Data exchange and software updating by USB (standard)
- Data exchange with FIELD Trace software (optional).
- T.U.V.R. protocol compatibility (Trimble®)
- Multilingual menu
- Simplified work parameter entry
- 8 customised nozzle parameter storage (in addition to ISO nozzles).
- Configurable units of measurement: Metric / US.
- Configuration of 10 different types of treatment.
- Visual and acoustic alarms
- Integrated diagnostic tool
- Foam marker management (only for CS version)
- Parameters managed: pressure, speed, flow rate, treated area, distributed quantity, treatment duration, distance travelled, tank level.

Компьютер для распределения фитосанитарных средств, предназначен для использования с штанговыми опрыскивателями, опрыскивателями и многорядными машинами.

Caratteristiche:

- Версии: до 7 секционных клапанов и 9 гидравлических клапанов.
- Автоматический и ручной режим функционирования.
- Соединительная коробка (Driver Box) с упрощенным и быстрым монтажом.
- Большой ЖК-дисплей с задней подсветкой, считываемый при любых параметрах света.
- Возможность подсоединения системы спутниковой навигации (опция - Farmnavigator®) и автоматическая система управления закрытием секций.
- Обмен данных и обновление ПО через USB (стандартный).
- Обмен данных с FIELD Trace (опция).
- Совместимость с протоколом T.U.V.R. (Trimble®)
- Меню на нескольких языках.
- Удобный ввод рабочих параметров.
- Сохранение параметров 8 персонализированных форсунок (в дополнение к форсункам ISO).
- Конфигурируемые единицы измерения: Метрические / US.
- Конфигурация 10 различных видов обработки
- Световая и звуковая аварийная сигнализация.
- Встроенный блок диагностики
- Управление пенным маркером (только для версии CS)
- Контролируемые параметры: давление, скорость, расход, обработанная площадь, распределенное количество, длительность обработки, пройденное расстояние, уровень цистерны.

260 CS



Pag. 16

260 CS H



Pag. 18

260 OS



Pag. 20

260 MRS



Pag. 20

GeoSystem 260 CS



Part No.	Section Valves (W)	Description	Pack
8410054	3	GeoSystem 260 3W CS	1
8410055	4	GeoSystem 260 4W CS	1
8410056	5	GeoSystem 260 5W CS	1
8410057	7	GeoSystem 260 7W CS	1

Section valves from 9 to 16 on demand

FEATURES

Display Dimension 123 x 30.4 mm	Display Resolution 280 x 64 pixel	Display Type FSTN Graphical Monochromatic	Display Light White Backlight	USB plug ✓
Language IT-EN-ES FR-DE-PT RU-PL-FI	kg ~1	°C -20 +60	V dc 9.5 - 32	A < 0,5
			Protection IP 67	case PA66 GF 30

DIMENSIONS

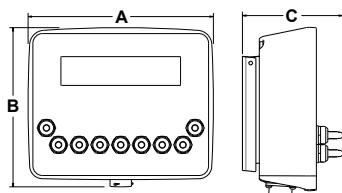

AxBxC mm
192x165x97,5

Campo di impiego / Use / Применение



Composizione del kit / Kit composed of / Комплектация

SPARE PARTS Pag. 59-61

A Monitor Monitor Дисплей		I Cavo collegamento tracciafile Foam marker connecting cable Соединительный кабель маркера пены	L = 0,4 m
B Scatola di derivazione Driver Box W Connecting box: Driver Box W Соединительная коробка: Driver Box W		J Cavo adattatore flussometro Flow meter adapter cable Кабель с адаптером расходомера	L = 0,5 m
D Cavo collegamento Monitor - Driver Box W Connecting cable Monitor - Driver Box W Соединительный кабель дисплея - Driver Box W	L = 5,0 m	K Sensore di velocita' Speed sensor Датчик скорости	L = 5,0 m
F Cavo collegamento valvole: Sezione, Generale, Proporzionale Connecting cable to valves: Section, Main, Proportional Соединительный кабель клапанов: секционного, главного, пропорционального	L = 1,2 m	L Staffa di fissaggio Mounting bracket Монтажный кронштейн	

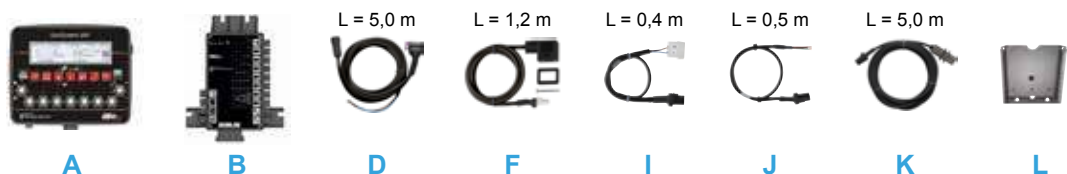

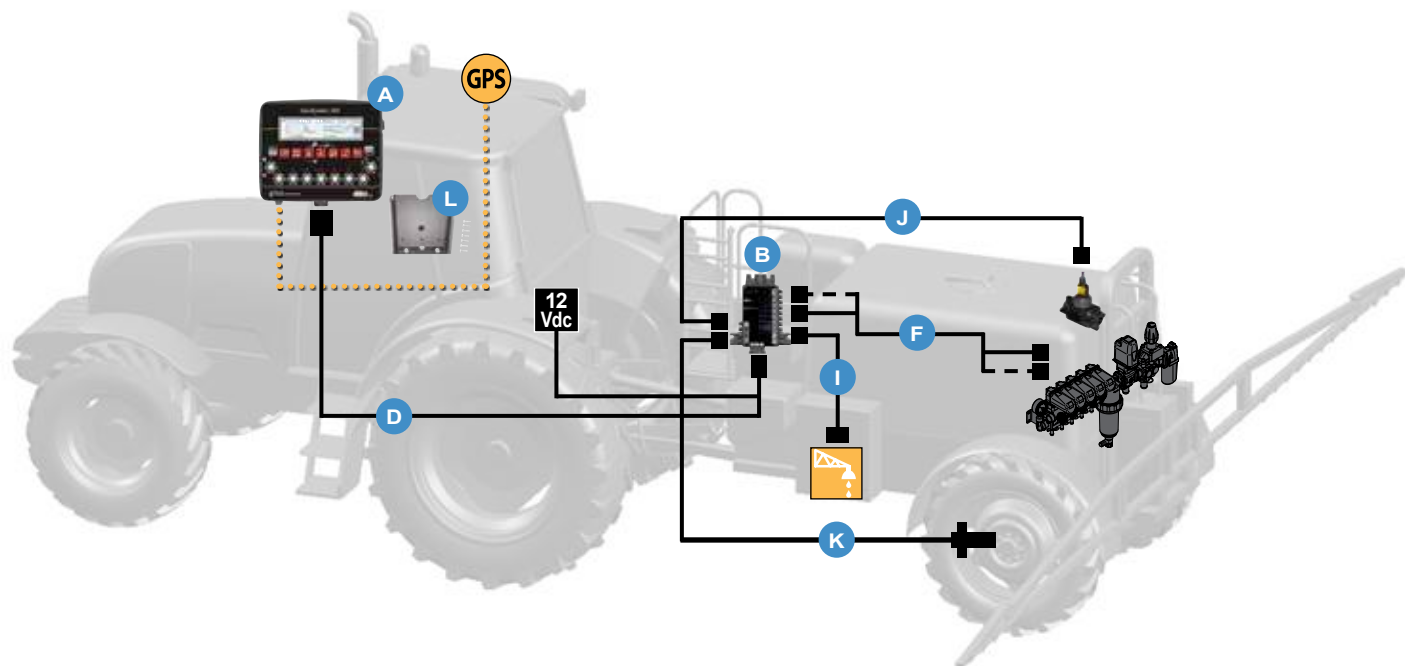

OPTIONALS

PAGE			PAGE		
52	Antenna GPS GPS antenna Антенна GPS		49	Cavo collegamento Monitor - Driver Box W Monitor-Driver Box W connecting cable Соединительный кабель дисплея- Driver Box W	L = 11,0 m
115-120	Flussometro Flowmeter Расходомер		50	Cavo collegamento valvole: Sezione, Generale, Proporzionale Connecting cable to valves: Section, General, Proportional Соединительный кабель клапанов: секционного, главного, пропорционального	L = 6,0 m L = 10,0 m
117	Sensore di flusso Flow sensor Датчик потока		51	Prolunga per cavo collegamento Monitor - Driver Box W Extension for Monitor-Driver Box W connecting cable Удлинитель для соединительного кабеля дисплея - Driver Box W	L=3,0 m L=5,0 m
60	Cavo adattatore flussometro Flow meter adapter cable Кабель с адаптером расходомера	L = 0,5 m	51	Prolunga per cavo collegamento Monitor - Driver Box H Extension for Monitor-Driver Box H connecting cable Удлинитель для соединительного кабеля дисплея - Driver Box H	L=3,0 m L=5,0 m
48	Sensore di pressione Pressure sensor Датчик давления	20 bar 4-20 mA L = 5,0 m	53	Staffa ventosa con sfera + Supporto a sfera per fissaggio monitor Suction cup bracket with ball + Monitor holder with ball Кронштейн на присосе со сферой + Суппорт со сферой для крепления дисплея	
48	Sensore di pressione Pressure sensor Датчик давления	50 bar 4-20 mA L = 5,0 m	53	Staffa da palo con sfera (senza braccio di completamento) Pole bracket with ball (without supplementary arm) Кронштейн на опоре со сферой (без дополнительного рычага)	
48	Sensore di pressione Pressure sensor Датчик давления	100 bar 4-20 mA L = 5,0 m	54	Staffa da palo + Braccio + Supporto a sfera per fissaggio monitor Pole bracket + Arm + Monitor holder with ball Кронштейн на опоре + Рычаг + Суппорт со сферой для крепления дисплея	
48	Cavo adattatore sensore di pressione Pressure sensor adapter cable Кабель с адаптером датчика давления	L = 0,5 m	54	Braccio + Supporto a sfera per fissaggio monitor Arm + Monitor holder with ball Рычаг + Суппорт со сферой для крепления дисплея	
48	Sensore di livello completo di supporto per fissaggio Level sensor complete with mounting bracket Уровневый датчик с монтажным кронштейном	L = 0,5 m	54	Supporto a sfera per fissaggio monitor Monitor holder with ball Суппорт со сферой для крепления дисплея	
49	Cavo collegamento Sensore di livello - Driver Box Level sensor-Driver Box connecting cable Соединительный кабель уровневого датчика - Driver Box	L = 5,0 m	55	Kit collegamento tracciafile Foam marker connecting kit Набор для подключения пенного маркера	
49	Cavo adattatore sensore di livello Level sensor adapter cable Кабель с адаптером уровневого датчика	L = 0,5 m	53	Cavo collegamento GS260 con navigatore GPS (T.U.V.R. Trimble®) GS260 connection cable with GPS satnav (T.U.V.R. Trimble®) Кабель соединения GS260 с GPS-навигатором (T.U.V.R. Trimble®)	L=2,0 m

GeoSystem 260 CS H



Part No.	Section Valves (W)	Hydraulic Valves (H)	Description	Pack
8410058	5	5	GeoSystem 260 5W CS 5H	1
8410059	7	7	GeoSystem 260 7W CS 7H	1

FEATURES

Display Dimension 123 x 30.4 mm	Display Resolution 280 x 64 pixel	Display Type FSTN Graphical Monochromatic	Display Light White Backlight	USB plug ✓
Language IT-EN-ES FR-DE-PT RU-PL-FI	kg ~1	°C -20 +60	V dc 9.5 - 32	A < 0,5
		Protection IP 67	case PA66 GF 30	

DIMENSIONS

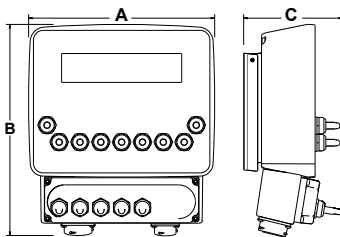

AxBxC mm
192x165x104,5

Campo di impiego / Use / Применение



Composizione del kit / Kit composed of / Комплектация

SPARE PARTS Pag. 59-61

A Monitor Monitor Дисплей		G Cavo collegamento valvola Generale Oleodinamica Connecting cable for main hydraulic valve Соединительный кабель главного гидравлического клапана	L = 1,4 m
B Scatola di derivazione Driver Box W Connecting box: Driver Box W Соединительная коробка: Driver Box W		H Cavo collegamento valvola Sezione Oleodinamica Connecting cable for hydraulic section valve Соединительный кабель секционного гидравлического клапана	L = 1,2 m
C Scatola di derivazione Driver Box H Connecting box: Driver Box H Соединительная коробка: Driver Box H		I Cavo collegamento tracciale Foam marker connecting cable Соединительный кабель пенного маркера	L = 0,4 m
D Cavo collegamento Monitor - Driver Box W Connecting cable Monitor - Driver Box W Соединительный кабель дисплея - Driver Box W	L = 5,0 m	J Cavo adattatore flussometro Flow meter adapter cable Кабель с адаптером расходомера	L = 0,5 m
E Cavo collegamento Monitor - Driver Box H Connecting cable Monitor - Driver Box H Соединительный кабель дисплея - Driver Box H	L = 5,0 m	K Sensore di velocità Speed sensor Датчик скорости	L = 5,0 m
F Cavo collegamento valvole: Sezione, Generale, Proporzionale Connecting cable to valves: Section, Main, Proportional Соединительный кабель клапанов: секционного, главного, пропорционального	L = 1,2 m	L Staffa di fissaggio Mounting bracket Монтажный кронштейн	

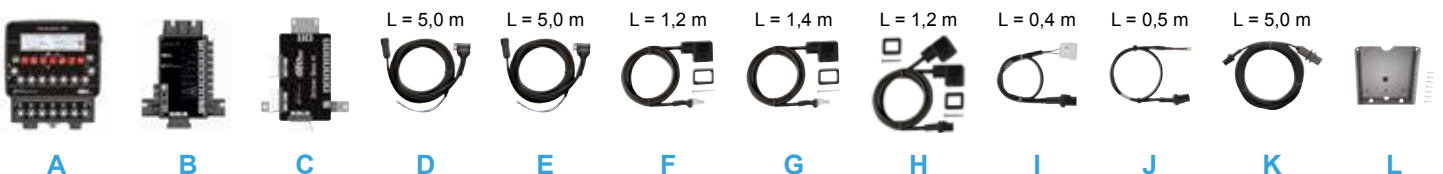

INSTALLATION

GS 260 CS H

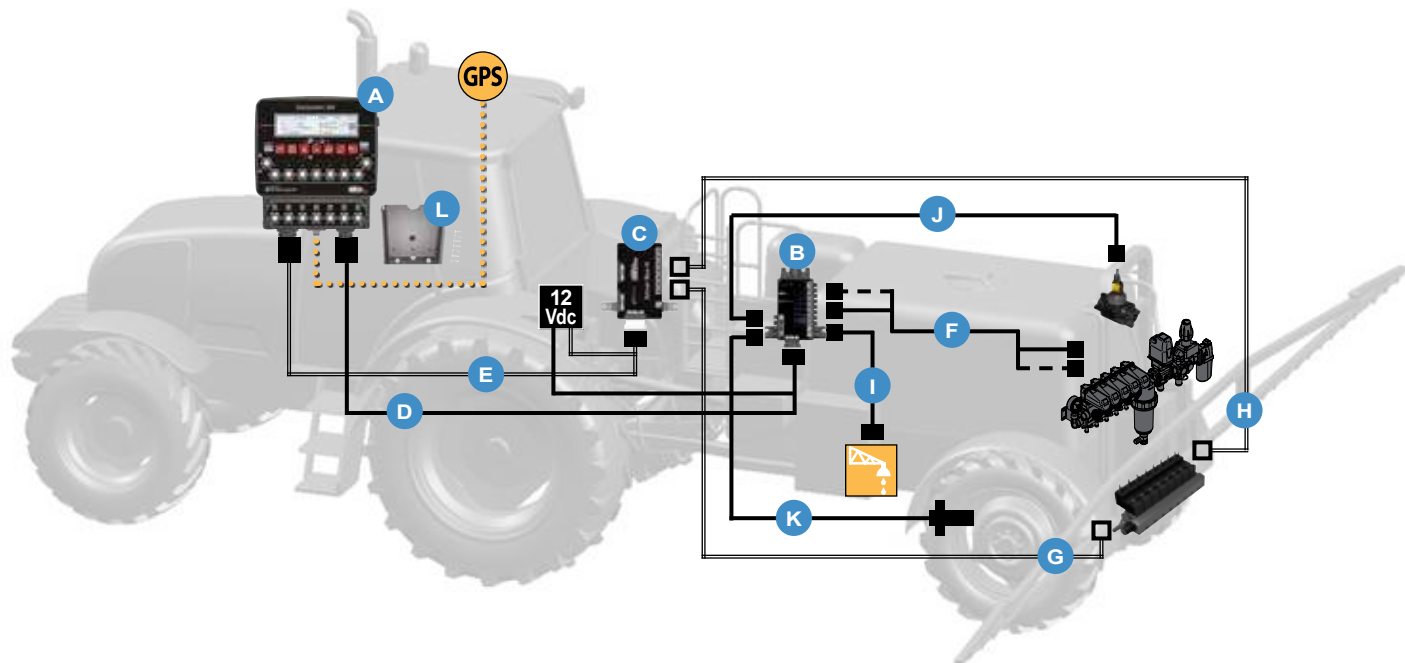

OPTIONALS

PAGE		PAGE			
52	Antenna GPS GPS antenna Антенна GPS		49	Cavo collegamento Monitor - Driver Box W Monitor-Driver Box W connecting cable Соединительный кабель дисплея- Driver Box W	L = 11,0 m
115-120	Flussometro Flowmeter Расходомер		50	Cavo collegamento valvole: Sezione, Generale, Proporzionale Connecting cable to valves: Section, General, Proportional Соединительный кабель клапанов: секционного, главного, пропорционального	L = 6,0 m L = 10,0 m
117	Sensore di flusso Flow sensor Датчик потока		51	Prolunga per cavo collegamento Monitor - Driver Box W Extension for Monitor-Driver Box W connecting cable Удлинитель для соединительного кабеля дисплея - Driver Box W	L=3,0 m L=5,0 m
60	Cavo adattatore flussometro Flow meter adapter cable Кабель с адаптером расходомера	L = 0,5 m	51	Prolunga per cavo collegamento Monitor - Driver Box H Extension for Monitor-Driver Box H connecting cable Удлинитель для соединительного кабеля дисплея - Driver Box H	L=3,0 m L=5,0 m
48	Sensore di pressione Pressure sensor Датчик давления	20 bar 4-20 mA L = 5,0 m	53	Staffa ventosa con sfera + Supporto a sfera per fissaggio monitor Suction cup bracket with ball + Monitor holder with ball Кронштейн на присосе со сферой + Суппорт со сферой для крепления дисплея	
48	Sensore di pressione Pressure sensor Датчик давления	50 bar 4-20 mA L = 5,0 m	53	Staffa da palo con sfera (senza braccio di completamento) Pole bracket with ball (without supplementary arm) Кронштейн на опоре со сферой (без дополнительного рычага)	
48	Sensore di pressione Pressure sensor Датчик давления	100 bar 4-20 mA L = 5,0 m	54	Staffa da palo + Braccio + Supporto a sfera per fissaggio monitor Pole bracket + Arm + Monitor holder with ball Кронштейн на опоре + Рычаг + Суппорт со сферой для крепления дисплея	
48	Cavo adattatore sensore di pressione Pressure sensor adapter cable Кабель с адаптером датчика давления	L = 0,5 m	54	Braccio + Supporto a sfera per fissaggio monitor Arm + Monitor holder with ball Рычаг + Суппорт со сферой для крепления дисплея	
48	Sensore di livello completo di supporto per fissaggio Level sensor complete with mounting bracket Уровневый датчик с монтажным кронштейном	L = 0,5 m	54	Supporto a sfera per fissaggio monitor Monitor holder with ball Суппорт со сферой для крепления дисплея	
49	Cavo collegamento Sensore di livello - Driver Box Level sensor-Driver Box connecting cable Соединительный кабель уровневого датчика - Driver Box	L = 5,0 m	55	Kit collegamento tracciafile Foam marker connecting kit Набор для подключения пенного маркера	
49	Cavo adattatore sensore di livello Level sensor adapter cable Кабель с адаптером уровневого датчика	L = 0,5 m	53	Cavo collegamento GS260 con navigatore GPS (T.U.V.R. Trimble®) GS260 connection cable with GPS satnav (T.U.V.R. Trimble®) Кабель соединения GS260 с GPS-навигатором (T.U.V.R. Trimble®)	L=2,0 m

GeoSystem 260 OS - GeoSystem 260 MRS



Part No.	Section Valves (W)	Description	Pack
8410047	2	GeoSystem 260 2W OS	1
8410048	4	GeoSystem 260 4W OS	1
8410049	2	GeoSystem 260 2W MRS	1
8410050	3	GeoSystem 260 3W MRS	1
8410051	4	GeoSystem 260 4W MRS	1
8410052	5	GeoSystem 260 5W MRS	1

FEATURES

Display Dimension 123 x 30.4 mm	Display Resolution 280 x 64 pixel	Display Type FSTN Graphical Monochromatic	Display Light White Backlight	USB plug <input checked="" type="checkbox"/>
Language IT-EN-ES FR-DE-PT RU-PL-FI	kg ~1	°C -20 +60	V dc 9.5 - 32	A < 0,5
	Protection IP 67		case PA66 GF 30	

DIMENSIONS

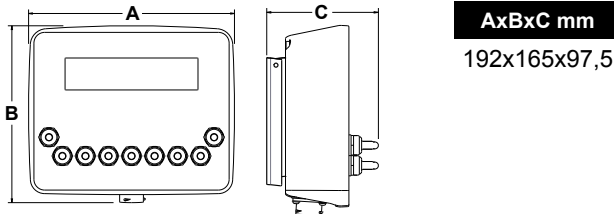

Campo di impiego / Use / Применение

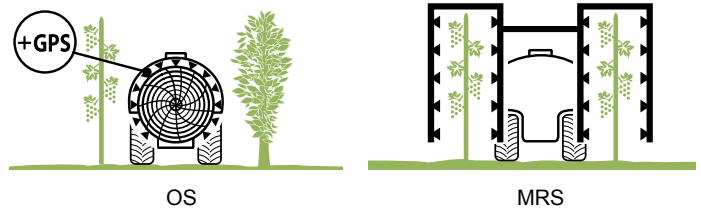

Composizione del kit / Kit composed of / Комплектация

SPARE PARTS Pag. 59-61

A Monitor Monitor Дисплей	J Cavo adattatore flussometro Flow meter adapter cable Кабель с адаптером расходомера	L = 0,5 m
B Scatola di derivazione Driver Box W Connecting box: Driver Box W Соединительная коробка Driver Box W	K Sensore di velocità Speed sensor Датчик скорости	L = 5,0 m
D Cavo collegamento Monitor - Driver Box W Connecting cable Monitor - Driver Box W Соединительный кабель дисплея - Driver Box W	L Staffa di fissaggio Mounting bracket Монтажный кронштейн	L = 5,0 m
F Cavo collegamento valvole: Sezione, Generale, Proporzionale Connecting cable to valves: Section, Main, Proportional Соединительный кабель клапанов: секционного, главного, пропорционального		L = 1,2 m



A



B

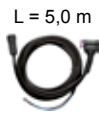

D



F

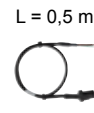

J



K



L

INSTALLATION

GS 260 OS - GS 260 MRS

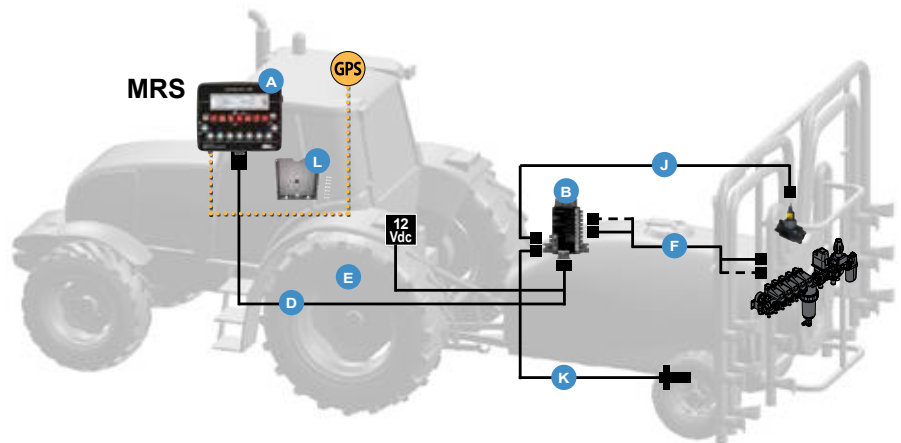
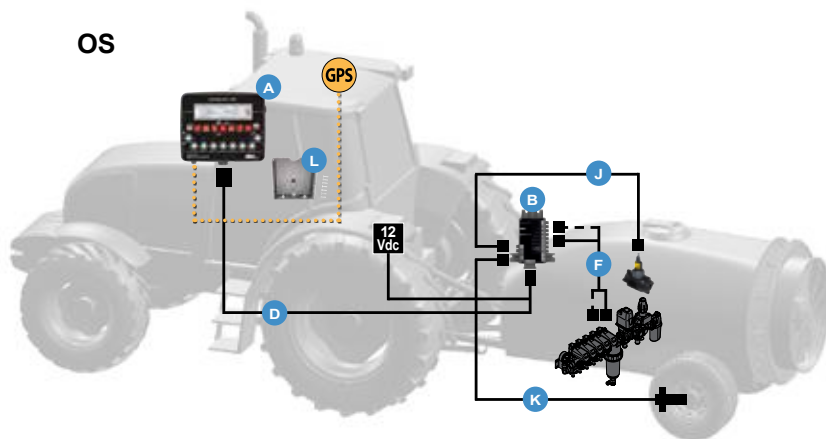

OPTIONALS

PAGE			PAGE		
52	Antenna GPS GPS antenna Антенна GPS		49	Cavo adattatore sensore di livello Level sensor adapter cable Кабель с адаптером уровневого датчика	L = 0,5 m
115-120	Flussometro Flowmeter Расходомер		49	Cavo collegamento Monitor - Driver Box W Monitor-Driver Box W connecting cable Соединительный кабель дисплея- Driver Box W	L = 11,0 m
117	Sensore di flusso Flow sensor Датчик потока		50	Cavo collegamento valvole: Sezione, Generale, Proporzionale Connecting cable to valves: Section, General, Proportional Соединительный кабель клапанов: секционного, главного, пропорционального	L = 6,0 m L = 10,0 m
60	Cavo adattatore flussometro Flow meter adapter cable Кабель с адаптером расходомера	L = 0,5 m	51	Prolunga per cavo collegamento Monitor - Driver Box W Extension for Monitor-Driver Box W connecting cable Удлинитель для соединительного кабеля дисплея - Driver Box W	L=3,0 m L=5,0 m
48	Sensore di pressione Pressure sensor Датчик давления	20 bar 4-20 mA L = 5,0 m	53	Staffa ventosa con sfera + Supporto a sfera per fissaggio monitor Suction cup bracket with ball + Monitor holder with ball Кронштейн на присоске со сферой + Суппорт со сферой для крепления дисплея	
48	Sensore di pressione Pressure sensor Датчик давления	50 bar 4-20 mA L = 5,0 m	53	Staffa da palo con sfera (senza braccio di completamento) Pole bracket with ball (without supplementary arm) Кронштейн на опоре со сферой (без дополнительного рычага)	
48	Sensore di pressione Pressure sensor Датчик давления	100 bar 4-20 mA L = 5,0 m	54	Staffa da palo + Braccio + Supporto a sfera per fissaggio monitor Pole bracket + Arm + Monitor holder with ball Кронштейн на опоре + Рычаг + Суппорт со сферой для крепления дисплея	
48	Cavo adattatore sensore di pressione Pressure sensor adapter cable Кабель с адаптером датчика давления	L = 0,5 m	54	Braccio + Supporto a sfera per fissaggio monitor Arm + Monitor holder with ball Рычаг + Суппорт со сферой для крепления дисплея	
48	Sensore di livello completo di supporto per fissaggio Level sensor complete with mounting bracket Уровневый датчик с монтажным кронштейном	L = 0,5 m	54	Supporto a sfera per fissaggio monitor Monitor holder with ball Суппорт со сферой для крепления дисплея	
49	Cavo collegamento Sensore di livello - Driver Box Level sensor-Driver Box connecting cable Соединительный кабель уровневого датчика - Driver Box	L = 5,0 m			



GeoSystem 250

Computer per distribuzione di prodotti fitosanitari, adatto per macchine da diserbo, atomizzatori e multi-filari.

Caratteristiche:

- Versioni: fino a 7 valvole di sezione e 9 valvole idrauliche.
- Funzionamento automatico e manuale.
- Scatola di derivazione (Driver Box) a cablaggio semplificato di rapida installazione.
- Display LCD retroilluminato di grandi dimensioni, leggibile in ogni condizione di luce.
- Menu multilingua
- Inserimento semplificato dei parametri di lavoro
- Memorizzazione parametri di 8 ugelli personalizzati (in aggiunta agli ugelli ISO).
- Unità di misura configurabili: Metrico / US.
- Configurazione di 10 diversi tipi di trattamento.
- Allarmi visivi e sonori
- Strumento di diagnostica integrato
- Gestione tracciafile (solo per versione CS)
- Parametri gestiti: pressione, velocità, portata, area trattata, quantità distribuita, durata del trattamento, distanza percorsa, livello cisterna.

Computer for distributing phytosanitary products, suitable for weed-killing machines, sprayers and multi-row machines.

Features:

- Versions: up to 7 section valves and 9 hydraulic valves.
- Automatic and manual operation.
- Connecting box (Driver Box) with simplified, quick-to-install wiring.
- Large, rear-lit LCD display, legible in all lighting conditions.
- Multilingual menu
- Simplified work parameter entry
- 8 customised nozzle parameter storage (in addition to ISO nozzles).
- Configurable units of measurement: Metric / US.
- Configuration of 10 different types of treatment.
- Visual and acoustic alarms
- Integrated diagnostic tool
- Foam marker management (only for CS version)
- Parameters managed: pressure, speed, flow rate, treated area, distributed quantity, treatment duration, distance travelled, tank level.

Компьютер для распределения фитосанитарных средств, предназначен для использования с штанговыми опрыскивателями, опрыскивателями и многорядными машинами.

Характеристики:

- Версии: до 7 секционных клапанов и 9 гидравлических клапанов.
- Автоматический и ручной режим функционирования.
- Соединительная коробка (Driver Box) с упрощенным и быстрым монтажом.
- Большой ЖК-дисплей с задней подсветкой, считываемый при любых параметрах света.
- Меню на нескольких языках.
- Удобный ввод рабочих параметров.
- Сохранение параметров 8 персонализированных форсунок (в дополнение к форсункам ISO).
- Конфигурируемые единицы измерения: Метрические / US.
- Конфигурация 10 различных видов обработки.
- Световая и звуковая аварийная сигнализация.
- Встроенный блок диагностики.
- Управление пенным маркером (только для версии CS)
- Контролируемые параметры: давление, скорость, расход, обработанная площадь, распределенное количество, длительность обработки, пройденное расстояние, уровень цистерны.

250 CS



Pag. 24

250 CS H



Pag. 26

250 OS



Pag. 28

250 MRS













Pag. 28

GeoSystem 250 CS



Part No.	Section Valves (W)	Description	Pack
8410043	3	GeoSystem 250 3W CS	1
8410044	4	GeoSystem 250 4W CS	1
8410045	5	GeoSystem 250 5W CS	1
8410060	7	GeoSystem 250 7W CS	1

FEATURES

 Display Dimension 123 x 30.4 mm	 Display Type Alphanumeric 16x2 Monochromatic	 Display Light Green Backlight
 Language IT-EN-ES FR-DE-PT-RU PL-FI-UA-GR	 kg ~1	 °C -20 +60
 V dc 9.5 - 32	 A < 0,5	 Protection IP 67
 case PA66 GF 30		

DIMENSIONS

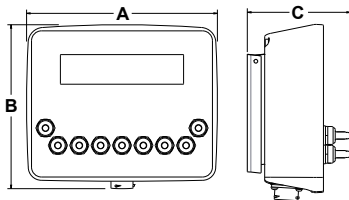

AxBxC mm
192x165x97,5

Campo di impiego / Use / Применение

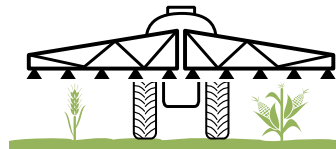

Composizione del kit / Kit composed of / Комплектация



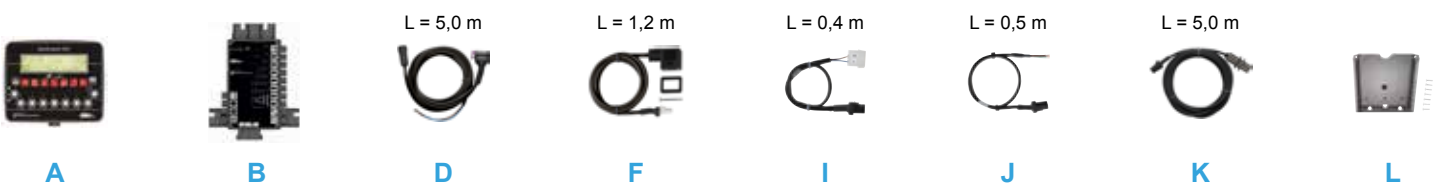

SPARE PARTS Pag. 59-61

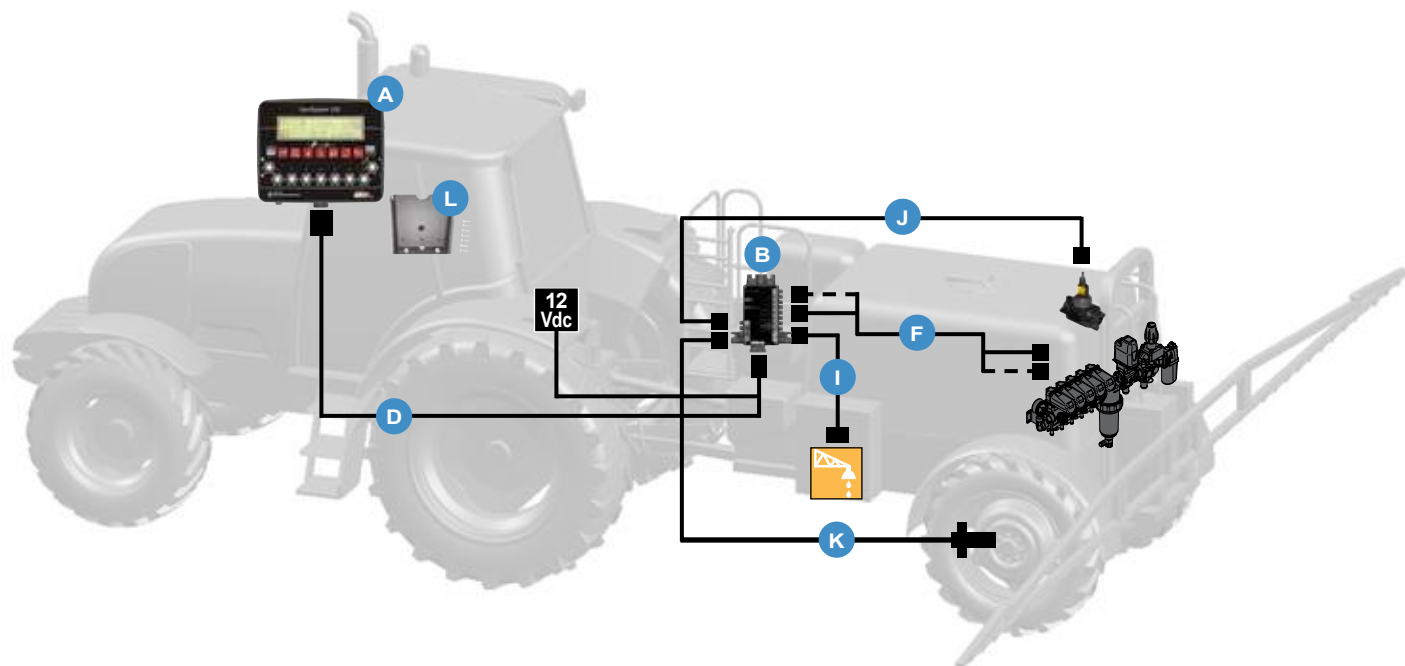
A Monitor Monitor Дисплей		I Cavo collegamento tracciafile Foam marker connecting cable Соединительный кабель маркера пены	L = 0,4 m
B Scatola di derivazione Driver Box W Connecting box: Driver Box W Соединительная коробка Driver Box W		J Cavo adattatore flussometro Flow meter adapter cable Кабель с адаптером расходомера	L = 0,5 m
D Cavo collegamento Monitor - Driver Box W Connecting cable Monitor - Driver Box W Соединительный кабель дисплея - Driver Box W	L = 5,0 m	K Sensore di velocita' Speed sensor Датчик скорости	L = 5,0 m
F Cavo collegamento valvole: Sezione, Generale, Proporzionale Connecting cable to valves: Section, Main, Proportional Соединительный кабель клапанов: секционного, главного, пропорционального	L = 1,2 m	L Staffa di fissaggio Mounting bracket Монтажный кронштейн	





OPTIONALS

PAGE		PAGE	
115-120	Flussometro Flowmeter Расходомер	49	Cavo collegamento Monitor - Driver Box W Monitor-Driver Box W connecting cable Соединительный кабель дисплея - Driver Box W L = 11,0 m
117	Sensore di flusso Flow sensor Датчик потока	50	Cavo collegamento valvole: Sezione, Generale, Proporzionale Connecting cable to valves: Section, General, Proportional Соединительный кабель клапанов: секционного, главного, пропорционального L = 6,0 m L = 10,0 m
60	Cavo adattatore flussometro Flow meter adapter cable Кабель с адаптером расходомера L = 0,5 m	51	Prolunga per cavo collegamento Monitor - Driver Box W Extension for Monitor-Driver Box W connecting cable Удлинитель для соединительного кабеля дисплея - Driver Box W L=3,0 m L=5,0 m
48	Sensore di pressione Pressure sensor Датчик давления  20 bar 4-20 mA L = 5,0 m	51	Prolunga per cavo collegamento Monitor - Driver Box H Extension for Monitor-Driver Box H connecting cable Удлинитель для соединительного кабеля дисплея - Driver Box H L=3,0 m L=5,0 m
48	Sensore di pressione Pressure sensor Датчик давления  50 bar 4-20 mA L = 5,0 m	53	Staffa ventosa con sfera + Supporto a sfera per fissaggio monitor Suction cup bracket with ball + Monitor holder with ball Кронштейн на присоске со сферой + Суппорт со сферой для крепления дисплея
48	Sensore di pressione Pressure sensor Датчик давления  100 bar 4-20 mA L = 5,0 m	53	Staffa da palo con sfera (senza braccio di completamento) Pole bracket with ball (without supplementary arm) Кронштейн на опоре со сферой (без дополнительного рычага)
48	Cavo adattatore sensore di pressione Pressure sensor adapter cable Кабель с адаптером датчика давления L = 0,5 m	54	Staffa da palo + Braccio + Supporto a sfera per fissaggio monitor Pole bracket + Arm + Monitor holder with ball Кронштейн на опоре + Рычаг + Суппорт со сферой для крепления дисплея
48	Sensore di livello completo di supporto per fissaggio Level sensor complete with mounting bracket Уровневый датчик с монтажным кронштейном L = 0,5 m	54	Braccio + Supporto a sfera per fissaggio monitor Arm + Monitor holder with ball Рычаг + Суппорт со сферой для крепления дисплея
49	Cavo collegamento Sensore di livello - Driver Box Level sensor-Driver Box connecting cable Соединительный кабель уровневого датчика - Driver Box L = 5,0 m	54	Supporto a sfera per fissaggio monitor Monitor holder with ball Суппорт со сферой для крепления дисплея
49	Cavo adattatore sensore di livello Level sensor adapter cable Кабель с адаптером уровневого датчика L = 0,5 m	55	Kit collegamento tracciafile Foam marker connecting kit Набор для подключения пенного маркера 

GeoSystem 250 CS H



Part No.	Section Valves (W)	Hydraulic Valves (H)	Description	Pack
8410046	5	5	GeoSystem 250 5W CS 5H	1
8410061	5	7	GeoSystem 250 5W CS 7H	1
8410062	7	7	GeoSystem 250 7W CS 7H	1
8410063	5	2	GeoSystem 250 5W CS 2H	1
8410064	7	2	GeoSystem 250 7W CS 2H	1

FEATURES

Display Dimension 123 x 30.4 mm	Display Type Alphanumeric 16x2 Monochromatic	Display Light Green Backlight
Language IT-EN-ES FR-DE-PT-RU PL-FI-UA-GR	kg ~1	°C -20 +60
V dc 9.5 - 32	A < 0,5	Protection IP 67
	case PA66 GF 30	

DIMENSIONS

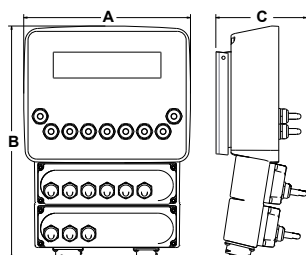

AxBxC mm
192x268x112,5

Campo di impiego / Use / Применение



Composizione del kit / Kit composed of / Комплектация

SPARE PARTS Pag. 59-61

A Monitor Monitor Дисплей		G Cavo collegamento valvola Generale Oleodinamica Connecting cable for main hydraulic valve Соединительный кабель главного гидравлического клапана	L = 1,4 m
B Scatola di derivazione Driver Box W Connecting box: Driver Box W Соединительная коробка Driver Box W		H Cavo collegamento valvola Sezione Oleodinamica Connecting cable for hydraulic section valve Соединительный кабель секционного гидравлического клапана	L = 1,2 m
C Scatola di derivazione Driver Box H Connecting box: Driver Box H Соединительная коробка Driver Box H		I Cavo collegamento tracciale Foam marker connecting cable Соединительный кабель маркера пены	L = 0,4 m
D Cavo collegamento Monitor - Driver Box W Connecting cable Monitor - Driver Box W Соединительный кабель дисплея - Driver Box W	L = 5,0 m	J Cavo adattatore flussometro Flow meter adapter cable Кабель с адаптером расходомера	L = 0,5 m
E Cavo collegamento Monitor - Driver Box H Connecting cable Monitor - Driver Box H Соединительный кабель дисплея - Driver Box H	L = 5,0 m	K Sensore di velocità Speed sensor Датчик скорости	L = 5,0 m
F Cavo collegamento valvole: Sezione, Generale, Proporzionale Connecting cable to valves: Section, Main, Proportional Соединительный кабель клапанов: секционного, главного, пропорционального	L = 1,2 m	L Staffa di fissaggio Mounting bracket Монтажный кронштейн	

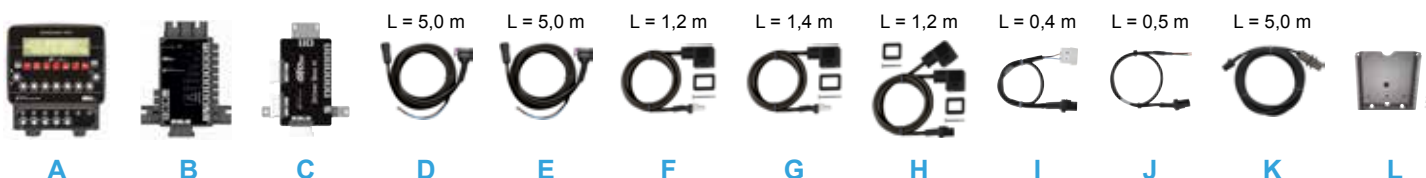



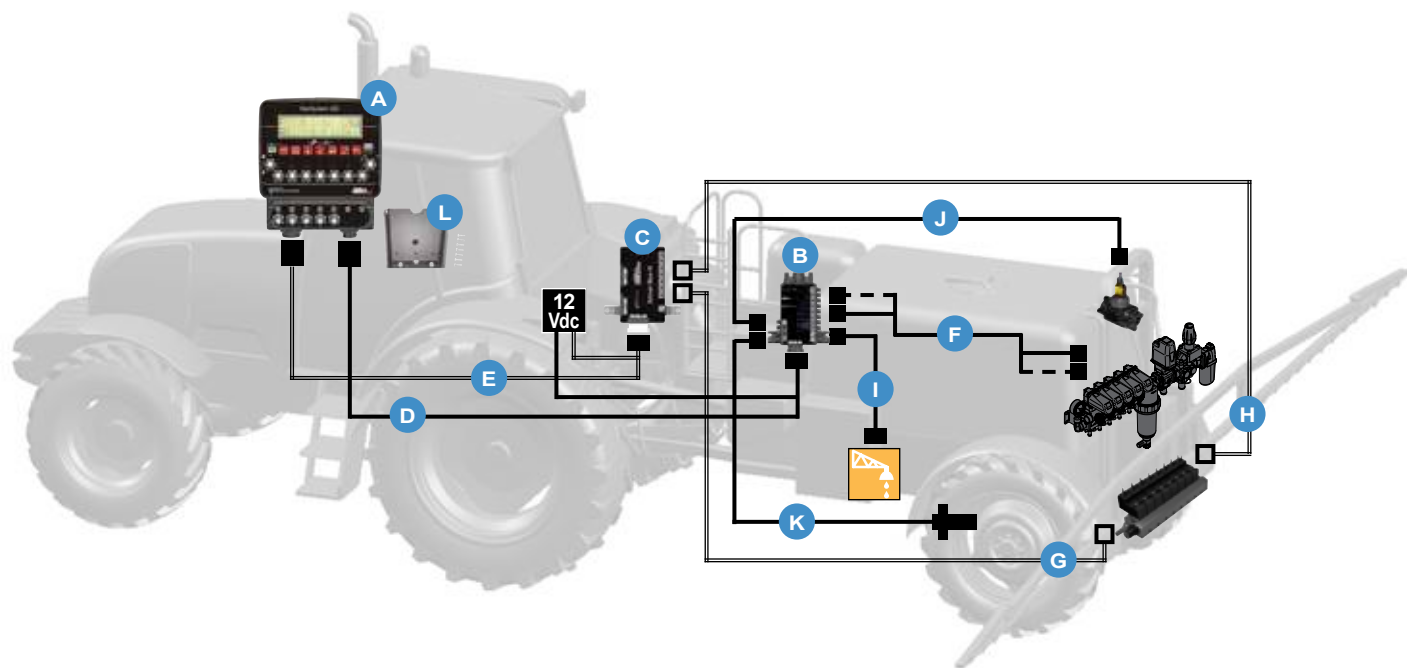

INSTALLATION

GS 250 CS H



OPTIONALS











PAGE		PAGE	
115-120	Flussometro Flowmeter Расходомер	49	Cavo collegamento Monitor - Driver Box W Monitor-Driver Box W connecting cable Соединительный кабель дисплея- Driver Box W L = 11,0 m
117	Sensore di flusso Flow sensor Датчик потока	50	Cavo collegamento valvole: Sezione, Generale, Proporzionale Connecting cable to valves: Section, General, Proportional Соединительный кабель клапанов: секционного, главного, пропорционального L = 6,0 m L = 10,0 m
60	Cavo adattatore flussometro Flow meter adapter cable Кабель с адаптером расходомера L = 0,5 m	51	Prolunga per cavo collegamento Monitor - Driver Box W Extension for Monitor-Driver Box W connecting cable Удлинитель для соединительного кабеля дисплея - Driver Box W L=3,0 m L=5,0 m
48	Sensore di pressione Pressure sensor Датчик давления  20 bar 4-20 mA L = 5,0 m	51	Prolunga per cavo collegamento Monitor - Driver Box H Extension for Monitor-Driver Box H connecting cable Удлинитель для соединительного кабеля дисплея - Driver Box H L=3,0 m L=5,0 m
48	Sensore di pressione Pressure sensor Датчик давления  50 bar 4-20 mA L = 5,0 m	53	Staffa ventosa con sfera + Supporto a sfera per fissaggio monitor Suction cup bracket with ball + Monitor holder with ball Кронштейн на присоске со сферой + Суппорт со сферой для крепления дисплея
48	Sensore di pressione Pressure sensor Датчик давления  100 bar 4-20 mA L = 5,0 m	53	Staffa da palo con sfera (senza braccio di completamento) Pole bracket with ball (without supplementary arm) Кронштейн на опоре со сферой (без дополнительного рычага)
48	Cavo adattatore sensore di pressione Pressure sensor adapter cable Кабель с адаптером датчика давления L = 0,5 m	54	Staffa da palo + Braccio + Supporto a sfera per fissaggio monitor Pole bracket + Arm + Monitor holder with ball Кронштейн на опоре + Рычаг + Суппорт со сферой для крепления дисплея
48	Sensore di livello completo di supporto per fissaggio Level sensor complete with mounting bracket Уровневый датчик с монтажным кронштейном L = 0,5 m	54	Braccio + Supporto a sfera per fissaggio monitor Arm + Monitor holder with ball Рычаг + Суппорт со сферой для крепления дисплея
49	Cavo collegamento Sensore di livello - Driver Box Level sensor-Driver Box connecting cable Соединительный кабель уровневого датчика - Driver Box L = 5,0 m	54	Supporto a sfera per fissaggio monitor Monitor holder with ball Суппорт со сферой для крепления дисплея
49	Cavo adattatore sensore di livello Level sensor adapter cable Кабель с адаптером уровневого датчика L = 0,5 m	55	Kit collegamento tracciafile Foam marker connecting kit Набор для подключения пенного маркера 

GeoSystem 250 OS - GeoSystem 250 MRS



Part No.	Section Valves (W)	Description	Pack
8410037	2	GeoSystem 250 2W OS	1
8410038	4	GeoSystem 250 4W OS	1
8410039	2	GeoSystem 250 2W MRS	1
8410040	3	GeoSystem 250 3W MRS	1
8410041	4	GeoSystem 250 4W MRS	1
8410042	5	GeoSystem 250 5W MRS	1

FEATURES

 Display Dimension 123 x 30.4 mm	 Display Type Alphanumeric 16x2 Monochromatic	 Display Light Green Backlight
 Language IT-EN-ES FR-DE-PT-RU PL-FI-UA-GR	 kg ~1	 °C -20 +60
 V dc 9.5 - 32	 A < 0,5	 Protection IP 67
 case PA66 GF 30		

DIMENSIONS

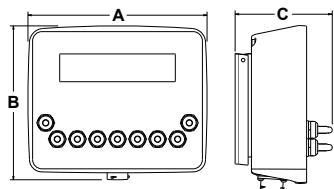

AxBxC mm
192x165x97,5

Campo di impiego / Use / Применение

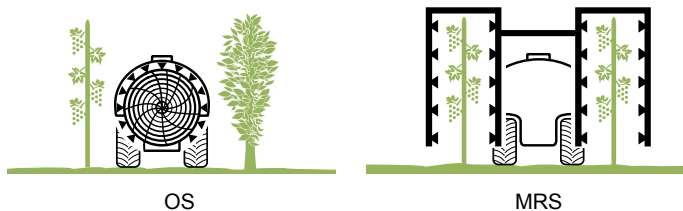

Composizione del kit / Kit composed of / Комплектация

SPARE PARTS Pag. 59-61

A Monitor Monitor Дисплей	J Cavo adattatore flussometro Flow meter adapter cable Кабель с адаптером расходомера	L = 0,5 m
B Scatola di derivazione Driver Box W Connecting box: Driver Box W Соединительная коробка Driver Box W	K Sensore di velocità Speed sensor Датчик скорости	L = 5,0 m
D Cavo collegamento Monitor - Driver Box W Connecting cable Monitor - Driver Box W Соединительный кабель дисплея - Driver Box W	L Staffa di fissaggio Mounting bracket Монтажный кронштейн	L = 5,0 m
F Cavo collegamento valvole: Sezione, Generale, Proporzionale Connecting cable to valves: Section, Main, Proportional Соединительный кабель клапанов: секционного, главного, пропорционального		L = 1,2 m



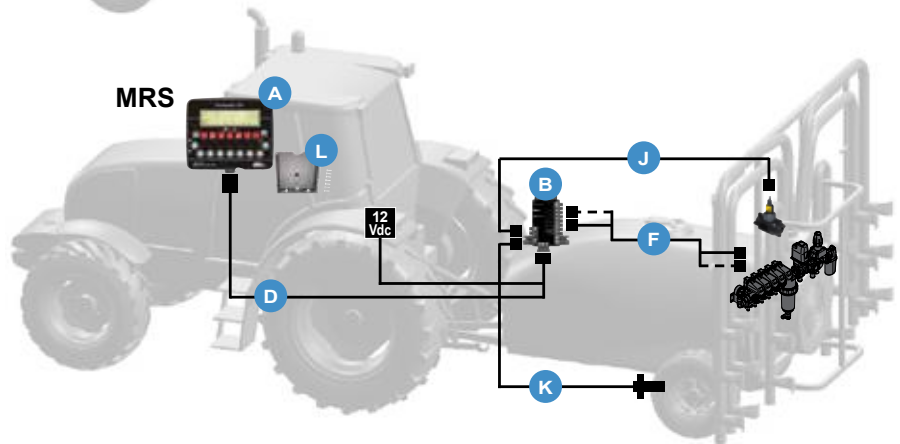
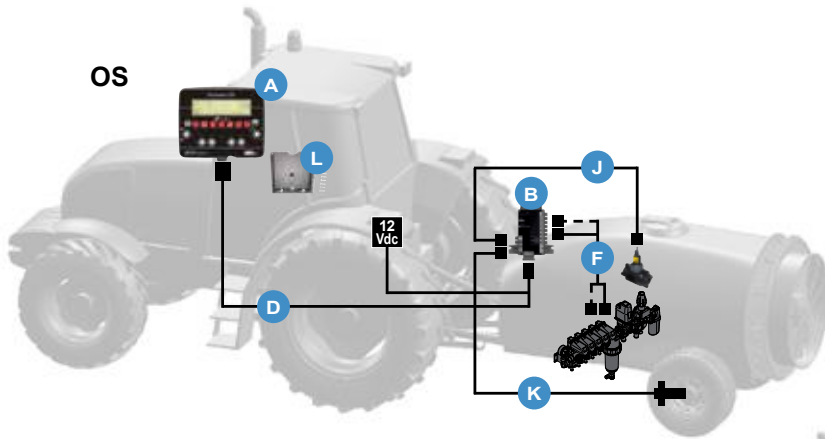

INSTALLATION

GS 250 OS - GS 250 MRS



OPTIONALS

PAGE		PAGE	
115 120	Flussometro Flowmeter Расходомер	49	Cavo collegamento Monitor - Driver Box W Monitor-Driver Box W connecting cable Соединительный кабель дисплея- Driver Box W L = 11,0 m
117	Sensore di flusso Flow sensor Датчик потока	50	Cavo collegamento valvole: Sezione, Generale, Proporzionale Connecting cable to valves: Section, General, Proportional Соединительный кабель клапанов: секционного, главного, пропорционального L = 6,0 m L = 10,0 m
60	Cavo adattatore flussometro Flow meter adapter cable Кабель с адаптером расходомера L = 0,5 m	51	Prolunga per cavo collegamento Monitor - Driver Box W Extension for Monitor-Driver Box W connecting cable Удлинитель для соединительного кабеля дисплея - Driver Box W L=3,0 m L=5,0 m
48	Sensore di pressione Pressure sensor Датчик давления  20 bar 4-20 mA L = 5,0 m	51	Prolunga per cavo collegamento Monitor - Driver Box H Extension for Monitor-Driver Box H connecting cable Удлинитель для соединительного кабеля дисплея - Driver Box H L=3,0 m L=5,0 m
48	Sensore di pressione Pressure sensor Датчик давления  50 bar 4-20 mA L = 5,0 m	53	Staffa ventosa con sfera + Supporto a sfera per fissaggio monitor Suction cup bracket with ball + Monitor holder with ball Кронштейн на присосе со сферой + Суппорт со сферой для крепления дисплея
48	Sensore di pressione Pressure sensor Датчик давления  100 bar 4-20 mA L = 5,0 m	53	Staffa da palo con sfera (senza braccio di completamento) Pole bracket with ball (without supplementary arm) Кронштейн на опоре со сферой (без дополнительного рычага)
48	Cavo adattatore sensore di pressione Pressure sensor adapter cable Кабель с адаптером датчика давления L = 0,5 m	54	Staffa da palo + Braccio + Supporto a sfera per fissaggio monitor Pole bracket + Arm + Monitor holder with ball Кронштейн на опоре + Рычаг + Суппорт со сферой для крепления дисплея
48	Sensore di livello completo di supporto per fissaggio Level sensor complete with mounting bracket Уровневый датчик с монтажным кронштейном L = 0,5 m	54	Braccio + Supporto a sfera per fissaggio monitor Arm + Monitor holder with ball Рычаг + Суппорт со сферой для крепления дисплея
49	Cavo collegamento Sensore di livello - Driver Box Level sensor-Driver Box connecting cable Соединительный кабель уровневого датчика - Driver Box L = 5,0 m	54	Supporto a sfera per fissaggio monitor Monitor holder with ball Суппорт со сферой для крепления дисплея
49	Cavo adattatore sensore di livello Level sensor adapter cable Кабель с адаптером уровневого датчика L = 0,5 m		

GeoSystem 240 OS+GPS/ GeoSystem 240 CS+GPS



Part No.	Section Valves (W)	Description	Pack
8410079	3	GeoSystem 240 CS GPS	1
8410080	5	GeoSystem 240 CS GPS	1
8410081	2	GeoSystem 240 OS GPS	1
8410082	4	GeoSystem 240 OS GPS	1

FEATURES

Display Dimension 123 x 30.4 mm	Display Type Alphanumeric 16x2 Monochromatic	Display Light Green Backlight
Language IT-EN-ES FR-DE-PT-RU PL-FI	kg ~1	°C -20 +60
V dc 9.5 - 32	A 6	Protection IP 67
		case PA66 GF 30

DIMENSIONS

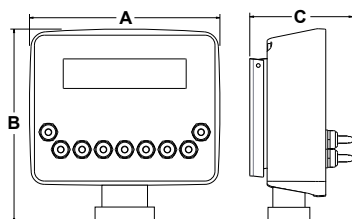

AxBxC mm
192x198x97,5

Campo di impiego / Use / Применение

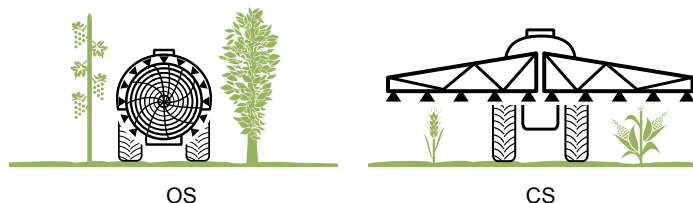

Composizione del kit / Kit composed of / Комплектация

SPARE PARTS Pag. 59-61

A Monitor Monitor Дисплей		K Sensore di velocita' Speed sensor Датчик скорости	L = 5,0 m
M Prolunga per cavo collegamento valvole + sensore Extension for valves + sensor connecting cable Удлинитель для соединительного кабеля клапанов + датчика	CS M-F 24P L = 7,0 m	J Cavo adattatore flussometro Flow meter adapter cable Кабель с адаптером расходомера	L = 0,5 m
M Prolunga per cavo collegamento valvole + sensore Extension for valves + sensor connecting cable Удлинитель для соединительного кабеля клапанов + датчика	OS M-F 24P L = 5,0 m	L Staffa di fissaggio Mounting bracket Монтажный кронштейн	
N Cavo collegamento valvole + sensore Valves + sensor connecting cable Соединительный кабель клапанов + датчиков	L = 1,2 m	O Antenna GPS GPS antenna Антенна GPS	



INSTALLATION

GS 240 OS - GS 240 CS

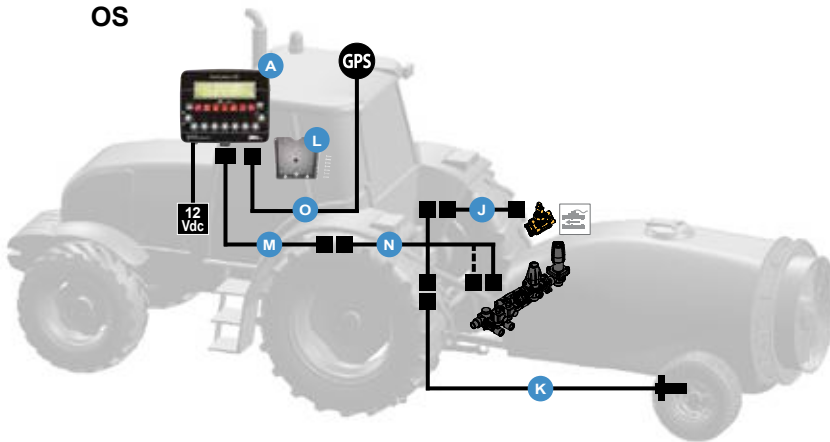

OS

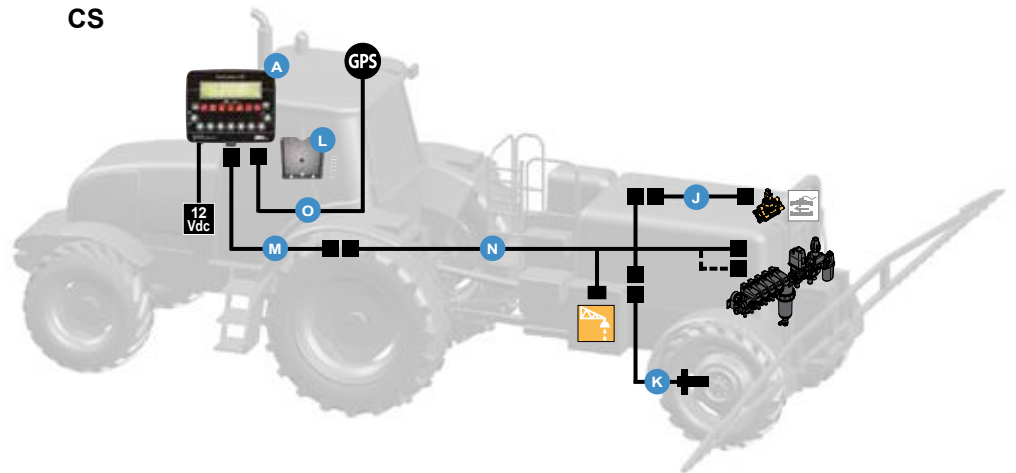

CS



OPTIONALS

PAGE		PAGE	
115-120	Flussometro Flowmeter Расходомер	49	Cavo collegamento Sensore di livello - Driver Box Level sensor-Driver Box connecting cable Соединительный кабель уровневого датчика - Driver Box L = 5,0 m
117	Sensore di flusso Flow sensor Датчик потока	49	Cavo adattatore sensore di livello Level sensor adapter cable Кабель с адаптером уровневого датчика L = 0,5 m
60	Cavo adattatore flussometro Flow meter adapter cable Кабель с адаптером расходомера L = 0,5 m	51	Prolunga per cavo collegamento valvole + sensore Extension for valves + sensor connecting cable Удлинитель для соединительного кабеля клапанов + датчика
48	Sensore di pressione Pressure sensor Датчик давления  20 bar 4-20 mA L = 5,0 m	53	Staffa ventosa con sfera + Supporto a sfera per fissaggio monitor Suction cup bracket with ball + Monitor holder with ball Кронштейн на присосе со сферой + Суппорт со сферой для крепления дисплея
48	Sensore di pressione Pressure sensor Датчик давления  50 bar 4-20 mA L = 5,0 m	53	Staffa da palo con sfera (senza braccio di completamento) Pole bracket with ball (without supplementary arm) Кронштейн на опоре со сферой (без дополнительного рычага)
48	Sensore di pressione Pressure sensor Датчик давления  100 bar 4-20 mA L = 5,0 m	54	Staffa da palo + Braccio + Supporto a sfera per fissaggio monitor Pole bracket + Arm + Monitor holder with ball Кронштейн на опоре + Рычаг + Суппорт со сферой для крепления дисплея
48	Cavo adattatore sensore di pressione Pressure sensor adapter cable Кабель с адаптером датчика давления L = 0,5 m	54	Braccio + Supporto a sfera per fissaggio monitor Arm + Monitor holder with ball Рычаг + Суппорт со сферой для крепления дисплея
48	Sensore di livello completo di supporto per fissaggio Level sensor complete with mounting bracket Уровневый датчик с монтажным кронштейном L = 0,5 m	54	Supporto a sfera per fissaggio monitor Monitor holder with ball Суппорт со сферой для крепления дисплея

GeoSystem 200



Caratteristiche:

- Installazione e collegamento semplici e veloci;
- Dimensioni ridotte e di facile installazione;
- Display LCD retroilluminato di grandi dimensioni, leggibile in ogni condizione di luce;
- Menu multilingua;
- Inserimento semplificato dei parametri di lavoro;
- Unità di misura configurabili: Metrico / US;
- Allarmi visivi e sonori;
- Strumento di diagnostica integrato.

- Funzione di stop automatico programmabile, durante il riempimento (stop pompa). Questa funzione è programmabile solo acquistando separatamente l'apposito cavo.

Features:

- Easy and quick installation and connection;
- Up to 4 sensors managing;
- Compact and easy to install;
- Large, backlit LCD display, legible in all lighting conditions;
- Multilingual menu;
- Simplified work parameter entry;
- Configurable units of measurement: Metric/US;
- Visual and audible alarms;
- Integrated diagnostic tool.

- Self-stop automatic settable function while refilling (pump stop). This function is settable only by purchasing the cable separately.

Характеристики:

- Простая и быстрая установка;
- Небольшие габариты и легкая установка;
- Большой ЖК-дисплей с задней подсветкой, считываемый при любых параметрах света;
- Меню на нескольких языках;
- Удобный ввод рабочих параметров;
- Конфигурируемые единицы измерения: Метрические / US;
- Световая и звуковая аварийная сигнализация;
- Встроенный блок диагностики;
- Контролируемые параметры: уровень цистерны.

- Возможность запрограммировать автоматическую остановку во время наполнения (остановка насоса). Для подключения данной функции необходимо докупить специальный провод.

FEATURES

Display Dimension 123 x 30.4 mm	Display Type Alphanumeric 16x2 Monochromatic	Display Light Green Backlight
Language IT-EN-ES FR-DE-PT RU-PL-FI	kg ~1	°C -20 +60
V dc 9.5 - 32	A < 0,5	Protection IP 67
case PA66 GF 30		

Campo di impiego / Use / Применение



DIMENSIONS

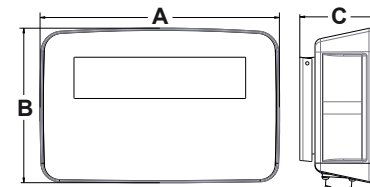

AxBxC mm
173x12,6x9x59,2



GeoSystem 200 - Level display

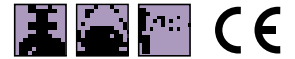

Visualizzatore adatto per macchine da diserbo, atomizzatori e multi-filari.

Display suitable for use on weed-killing machines, sprayers and multi-row machines.

Предназначен для использования с штанговыми опрыскивателями, опрыскивателями и многорядными машинами.

Consente di visualizzare il livello in cisterna.

Tank level displayed.



Part No.	Description	Pack
8408006	GeoSystem 200 - Level display	1

Composizione del kit / Kit composed of / Комплектация

A	Monitor Monitor Дисплей	
B	Cavo collegamento GS 200 - Sensore di livello GS 200 - Level sensor connecting cable Соед.кабель GS 200-Уровневый датчик	L = 5,0 m
C	Sensore di livello completo di supporto per fissaggio Level sensor complete with mounting bracket Уровневый датчик с монтажным кронштейном	
L	Staffa di fissaggio Mounting bracket Монтажный кронштейн	

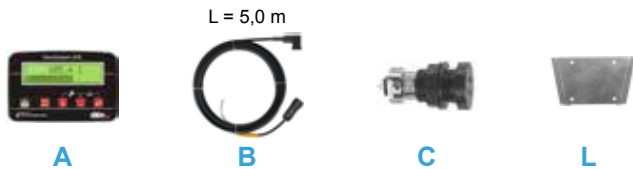

SPARE PARTS Pag. 48,61

INSTALLATION

GS 200

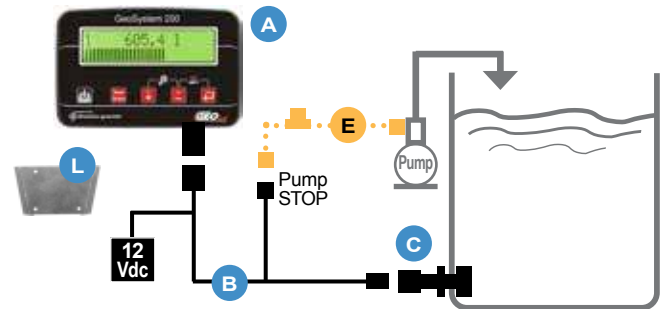

OPTIONALS

PAGE

55 Kit collegamento tracciafile + stop pompa GS200
Foam marker connecting kit + pump stop GS200
Соединительный комплект маркера пены+ остановка насоса GS200

E

GeoSystem 200 - Rate display



Visualizzatore adatto per macchine da diserbo, atomizzatori e multi-filari.

Display suitable for use on weed-killing machines, sprayers and multi-row machines.

Предназначен для использования с штанговыми опрыскивателями, опрыскивателями и многорядными машинами.

Consente di visualizzare

- misura istantanea della dose distribuita;
- superficie lavorata;
- velocità e flusso;
- tempo di lavoro.

Parameters managed:

- simultaneous flow rate measure;
- treated area;
- speed and flow;
- working time.

Контролируемые параметры:

- Мгновенный замер разбрызганной дозы;
- обработанная площадь;
- скорость и напор потока;
- продолжительность работы.



Part No.	Description	Pack
8408005	GeoSystem 200 - Rate display	1

Composizione del kit / Kit composed of / Комплектация

A	Monitor Monitor Дисплей	
O	Cavo Alimentazione 2 sensori D+D 2 sensors D+D feeding cable Зарядяющий кабель для 2 датчиков D+D	L = 2,0 m
P	Sensore di velocità Speed sensor Датчик скорости	L = 5,0 m
Q	Flussometro ispezionabile con turbina e flange 1" Inspectable flowmeter with turbine and 1" flanges Разбирающийся расходомер с турбиной и фланцем 1"	L = 2,0 m
L	Staffa di fissaggio Mounting bracket Монтажный кронштейн	



SPARE PARTS Pag. 48,61

INSTALLATION

GS 200

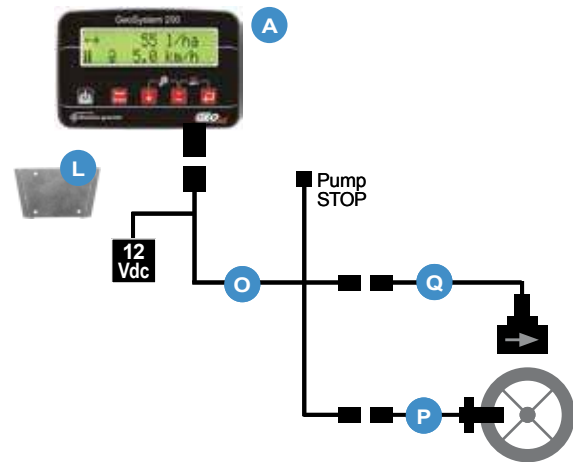

OPTIONALS

PAGE		PAGE	
54	Staffa ventosa con sfera Suction cup bracket with ball Кронштейн на присосе со сферой	112	Flange di accoppiamento Adapters Соединительный фланец
54	Staffa da palo + Braccio + Supporto a sfera per fissaggio monitor Pole bracket + Arm + Monitor holder with ball Кронштейн на опоре + Рычаг + Суппорт со сферой для крепления дисплея	113	Kit di assemblaggio Assembling kit Монтажный комплект
55	Kit collegamento tracciabile + stop pompa GS200 Foam marker connecting kit + pump stop GS200 Соединительный комплект маркера пены+ остановки насоса GS200		

GeoSystem 200 - RPM display



Visualizzatore adatto per macchine da diserbo, atomizzatori e multi-filari.

Display suitable for use on weed-killing machines, sprayers and multi-row machines.

Предназначен для использования с танговыми опрыскивателями, опрыскивателями и многорядными машинами.

Consente di visualizzare:

- misura velocità di organo in rotazione;
- misura pressione o livello cisterna.

Parameters managed:

- rotating speed measure;
- pressure or tank level measure.

Контролируемые параметры:

- скорость вращения установки;
- давление или уровень в цистерне;



Part No.	Description	Pack
8408007	GeoSystem 200 - RPM display	1

Composizione del kit / Kit composed of / Комплектация

A	Monitor Monitor Дисплей	
O	Cavo Alimentazione 2 sensori A+D 2 sensors A+D feeding cable Запитывающий кабель для 2 датчиков A+D	L = 2,0 m
P	Sensore di velocità Speed sensor Датчик скорости	L = 5,0 m
L	Staffa di fissaggio Mounting bracket Монтажный кронштейн	



SPARE PARTS Pag. 48,61

INSTALLATION

GS 200

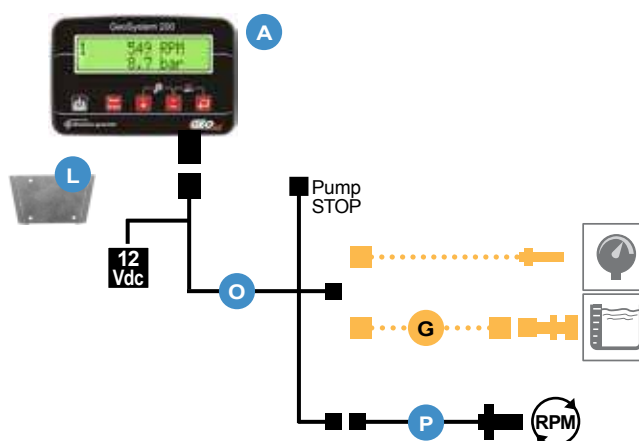

OPTIONALS

PAGE			PAGE		
48	Sensore di pressione Pressure sensor Датчик давления	20 bar 4-20 mA L = 5,0 m	48	Cavo collegamento Sensore di livello GS 200 Level sensor connecting cable GS 200 Соединительный кабель уровневого датчика GS 200	G L = 5,0 m
48	Sensore di pressione Pressure sensor Датчик давления	50 bar 4-20 mA L = 5,0 m	49	Cavo adattatore sensore di livello Level sensor adapter cable Кабель с адаптером уровневого датчика	L = 0,5 m
48	Sensore di pressione Pressure sensor Датчик давления	100 bar 4-20 mA L = 5,0 m	54	Staffa ventosa con sfera Suction cup bracket with ball Кронштейн на присосе со сферой	
48	Cavo adattatore sensore di pressione Pressure sensor adapter cable Кабель с адаптером датчика давления	L = 0,5 m	54	Staffa da palo + Braccio + Supporto a sfera per fissaggio monitor Pole bracket + Arm + Monitor holder with ball Кронштейн на опоре + Рычаг + Суппорт со сферой для крепления дисплея	
48	Sensore di livello completo di supporto per fissaggio Level sensor complete with mounting bracket Уровень датчик с монтажным кронштейном		55	Kit collegamento tracciabile + stop pompa GS200 Foam marker connecting kit + pump stop GS200 Соединительный комплект маркера пены+ остановки насоса GS200	

GeoSystem 190S



Sistema automatico di apertura delle elettrovalvole per atomizzatore, in grado di rilevare la presenza della pianta tramite sensore ad ultrasuoni. La distribuzione del prodotto è garantita solo sulla coltivazione, riducendo gli sprechi e salvaguardando l'ambiente. Misura diretta ed in tempo reale della quantità di prodotto erogato, ideale per certificazioni di coltivazioni biologiche.

Caratteristiche:

- Sistema automatico per la gestione di due valvole elettriche di sezione;
- Funzionamento manuale ed automatico;
- Display LCD retroilluminato;
- Possibilità di misurare la velocità e la distanza percorsa, tramite sensore alla ruota o tramite antenna GPS;
- Sincronizzazione apertura delle valvole in base alla velocità di avanzamento.
- Dati rilevati durante il trattamento: velocità, pressione, flusso, livello serbatoio, area trattata, quantità prodotto distribuito per area, numero di piante trattate, distanza percorsa e litri erogati per 100 metri lineari.

Automatic solenoid valve opening system for sprayers, able to detect plant presence via an ultrasound sensor.

The system ensures that the product is distributed only over the crops, reducing wastage and protecting the environment.

Direct, real-time product dosing, ideal for organic crop certifications.

Features:

- Automatic management system for two electric section valves;
- Manual and automatic operation;
- Backlit LCD display;
- Possibility to measure the speed and distance covered via wheel sensor or GPS antenna;
- Valve opening synchronisation on the basis of travel speed;
- Data measured during treatment: speed, pressure, flow, tank level, area treated, quantity of product applied per area, number of plants treated, distance covered and litres applied per 100 linear metres.

Автоматическая система открытия электромагнитных клапанов для распылителя, способная определить присутствие растения посредством ультразвукового датчика.

Гарантируется подача средства только на растение, снижая таким образом растраты при бережном отношении к окружающей среде.

Непосредственное измерение в реальном времени количества средства, что идеально подходит для сертификации биологических культур.

Caratteristiche:

- Автоматическая система управления двумя секционными электрическими клапанами;
- Ручной и автоматический режим функционирования;
- ЖК-дисплей с задней подсветкой;
- Возможность измерения скорости и пройденного расстояния посредством датчика на колесе или антенны GPS;
- Синхронизация открытия клапанов в зависимости от скорости движения;
- Данные, определяемые в процессе обработки: скорость, давление, поток, уровень бака, обработанная площадь, количество распределенного на обрабатываемом участке средства, количество обработанных растений, пройденное расстояние и литры средства, разбрызгиваемые на 100 линейных метров.



Part No.	Section Valves (W)	Description	Pack
8410035	2	GeoSystem 190S Basic	1
8410036	2	GeoSystem 190S Advanced	1
8410072	2	GeoSystem 190S Solenoid	1

FEATURES

Display Dimension 36 x 22,5 mm	Display Resolution 128x64 pixel	Display Type FSTN Graphical Monochromatic	Display Light White LED Backlight
Language IT-EN-ES PT-RU GR-UA	kg ~1	°C -20 +60	V dc 9.5 - 32
	A < 0,5	Protection IP 67	case PA66 GF 30

DIMENSIONS

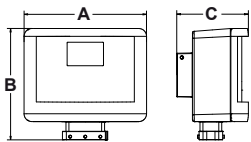

AxBxC mm
125x114x73

Campo di impiego / Use / Применение



Composizione del kit / Kit composed of / Комплектация

SPARE PARTS Pag. 59-61

A Monitor Monitor Дисплей		T Supporto sensore sonar (solo per Part No. 8410036) Sonar sensor support (only for Part No. 8410036) Суппорт Датчик sonar (solo per Part No. 8410036)
R Cavo alimentazione valvole + sensori Power cable for valves + sensors Кабель питания для клапанов и датчиков	L = 7,0 m	U Elettrovalvola a solenoide MY20 Electric Solenoid Valve MY20 Электромагнитный клапан MY20
S Sensore sonar (solo per Part No. 8410036) Sonar sensor (only for 8410036 Part No.) Датчик sonar (solo per Part No. 8410036)		L Staffa di fissaggio Mounting bracket Монтажный кронштейн
K Sensore di velocità Speed sensor Датчик скорости	L = 5,0 m	



A



R



S

*only for P/N 8410036



K



T



U

**only for P/N 8410072



L

INSTALLATION

GS 190S

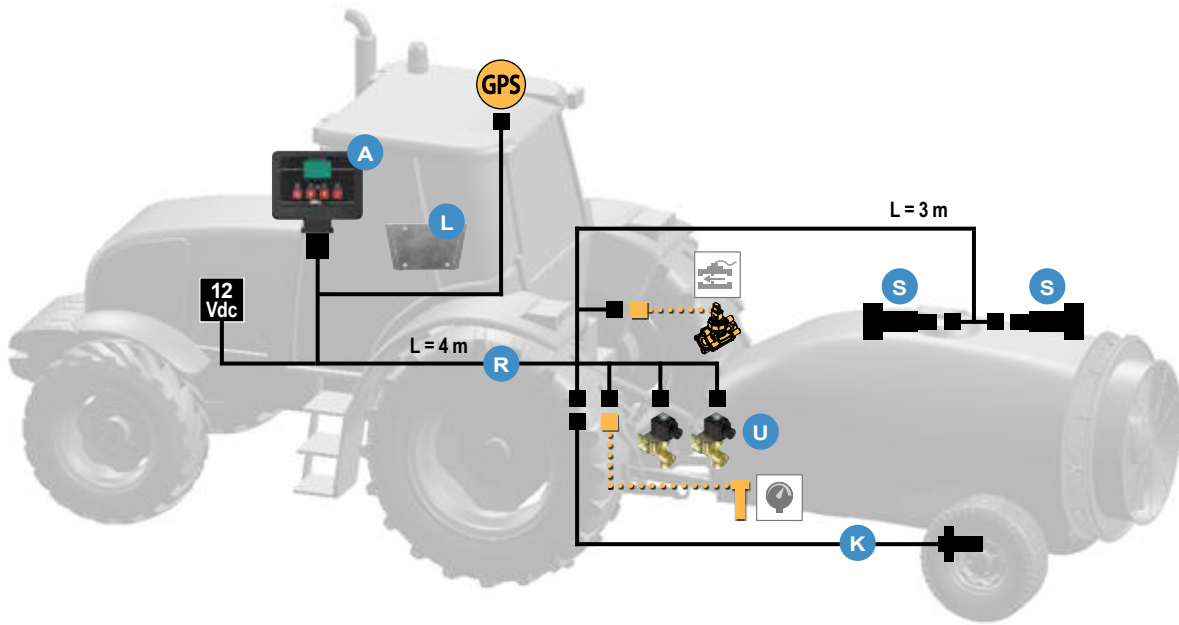

SONAR DETECTION

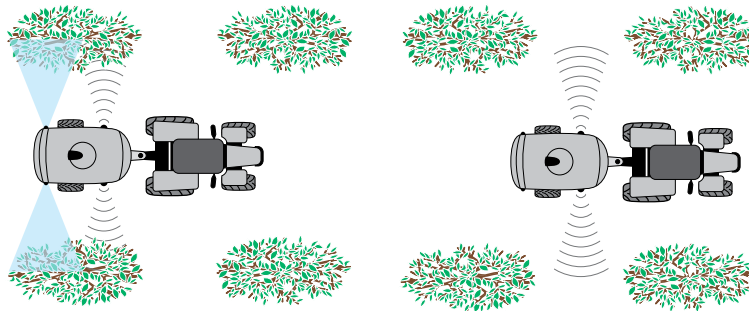

OPTIONALS

PAGE		PAGE	
52	Antenna GPS GPS antenna Антенна GPS		48
115-120	Flussometro Flowmeter Расходомер		48
117	Sensore di flusso Flow sensor Датчик потока		57
60	Cavo adattatore flussometro Flow meter adapter cable Кабель с адаптером расходомера	L = 0,5 m	57
48	Sensore di pressione Pressure sensor Датчик давления	20 bar 4-20 mA L = 5,0 m	123
48	Sensore di pressione Pressure sensor Датчик давления	50 bar 4-20 mA L = 5,0 m	129
48	Sensore di pressione Pressure sensor Датчик давления	100 bar 4-20 mA L = 5,0 m	
			48
			48
			57
			57
			123
			129

Special customized cables on demand

GeoRemote



Sistema per il controllo wireless di gruppi di comando con valvole motorizzate.

Caratteristiche:

- Un'unica applicazione Android scaricabile sul tuo smartphone (o tablet);
- Gestisce le valvole tramite DriverBox;
- Il controllo delle valvole viene effettuato tramite sistema Wi-Fi direct;
- L'unico collegamento necessario è il cavo di alimentazione della DriverBox;
- Lettura istantanea della pressione di lavoro;
- Segnalazione dello sfioramento del range di pressione impostato;
- Spia di stato valvola ON-OFF.

Control units with motorized valves' wireless system.

Features:

- One Android app for smartphone and tablets;
- Valves management through DriverBox;
- Valves full control through Wi-fi direct connection;
- Power supply cable in the Driver Box;
- Instantaneous operating pressure reading;
- Alarm on pressure range overruns;
- ON-OFF valve indicator light.

Система для беспроводного контроля управляющих узлов с приводными клапанами.

Характеристики:

- Единое приложение Android, которое вы можете скачать на свой смартфон (или планшет);
- Управляет клапанами через DriverBox;
- Управление клапанами производится через систему Wi-Fi Direct;
- Единственное необходимое соединение - кабель питания DriverBox;
- Моментальное считывание рабочего давления;
- Сигнализация о выходе за пределы заданного диапазона давления;
- Индикатор состояния клапана ВКЛ.-ВЫКЛ.



Part No.	Name	Description	Section Valves (W)	Main Valves	Proportional Valves	Foam Marker
8407017	Atom 1	Kit WI Atom 1	2	1	1	-
8407018	Atom 2	Kit WI Atom 2	4	1	1	-
8407019	Crop 3	Kit WI Crop 3	3	1	1	✓
8407020	Crop 5	Kit WI Crop 5	5	1	1	✓
8407021	Crop 7	Kit WI Crop 7	7	1	1	✓

kg	°C	V dc	Protection	case
~1	-20 +60	12	IP 67	PA66 GF 30

INSTALLATION

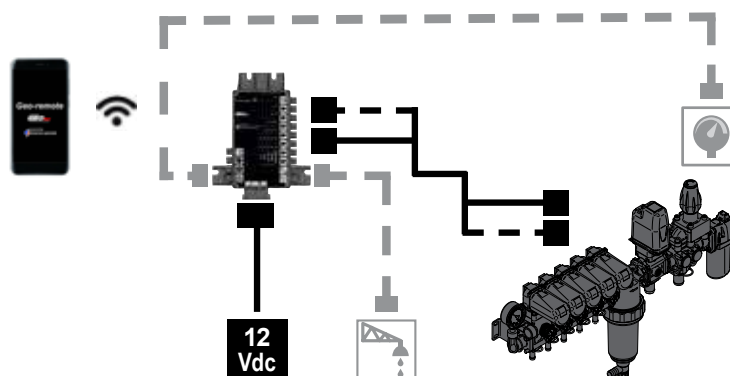

OPTIONALS

PAGE

60	Cavo collegamento tracciale Foam marker connecting cable Соединительный кабель пенного маркера	L = 0,4 m
48	Sensore di pressione Pressure sensor Датчик давления	20 bar 4-20 mA L = 5,0 m
48	Sensore di pressione Pressure sensor Датчик давления	50 bar 4-20 mA L = 5,0 m
48	Sensore di pressione Pressure sensor Датчик давления	100 bar 4-20 mA L = 5,0 m

KIT WI CROP 7 WORKING SCREEN

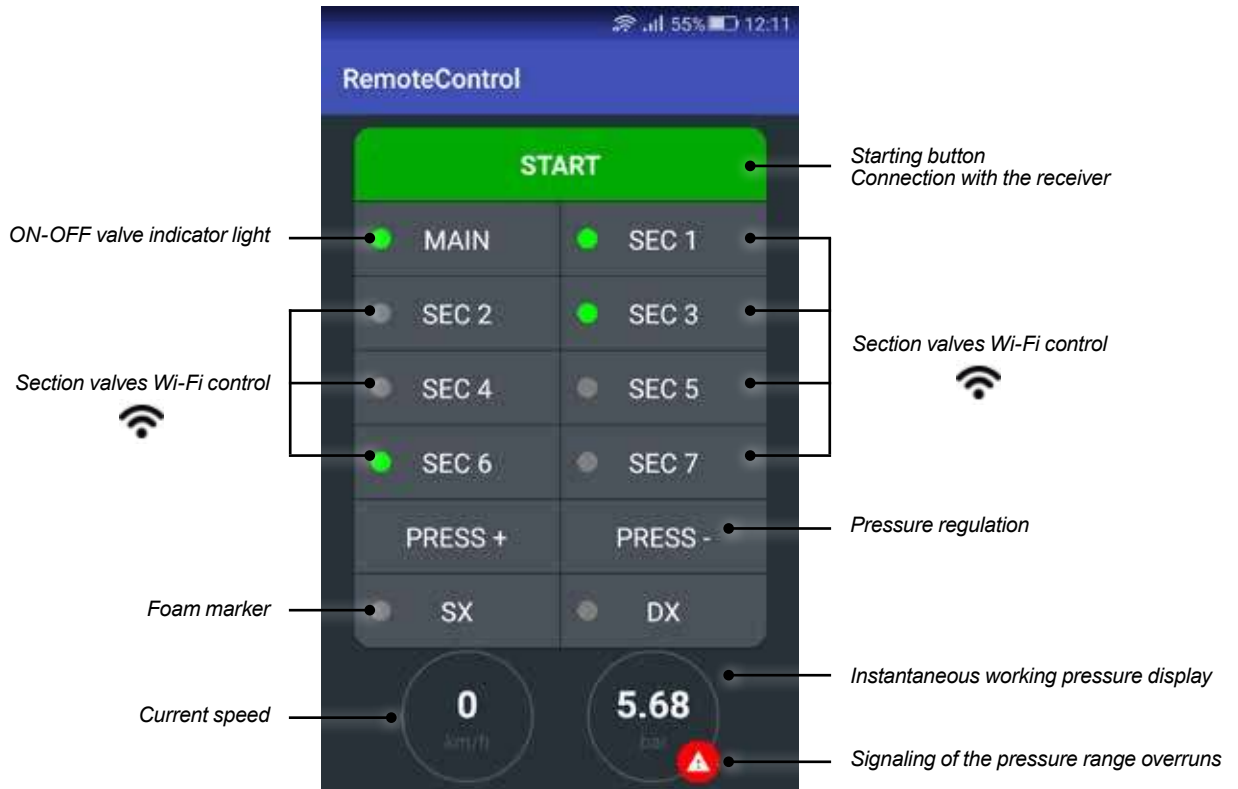

REMOTE CONTROL LAYOUT SCREEN

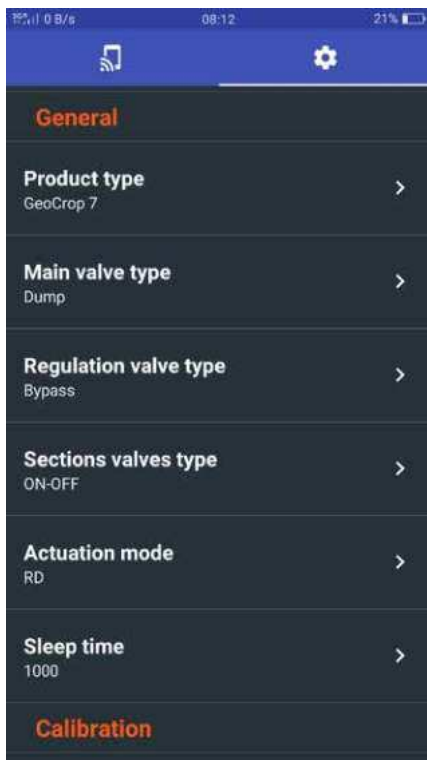

SENSOR LAYOUT SCREEN



Compact 50 WM

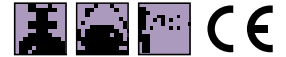

Scatole comando predisposte per manometro.
A 2-3-5 sezioni.
****RD:** dove la valvola generale in OFF chiude automaticamente tutte le valvole di sezione.
***RI:** con valvole di sezione indipendenti.

Control boxes to be completed with pressure gauge.
With 2-3-5 section valves.
****RD:** with section valves controlled by the main valve.
***RI:** with independent section valves.

Блоки управления с возможностью подключения манометра.
С 2-3-5 секционными клапанами.
****RD:** при отключении главного клапана, автоматически отключаются все секционные клапаны.
***RI:** с независимыми секционными клапанами.



FEATURES

kg °C V dc
~1 60 12

INSTALLATION

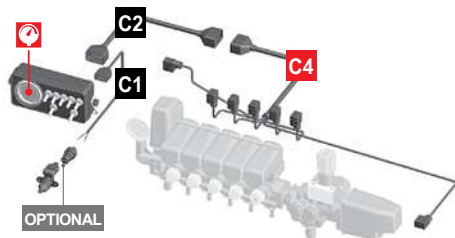

Campo di impiego / Use / Применение



Part No.	Type	Section Valves V	Volumetric Valve P	Main Valve G	C1 L (m)	C2 L (m)	Pack
8406001	*RI	2	1	1	2,0	3,0	1
8406007	**RD	2	1	1	2,0	3,0	1
8406003	*RI	3	1	1	2,0	3,0	1
8406009	**RD	3	1	1	2,0	3,0	1
8406005	*RI	5	1	1	2,0	3,0	1
8406011	**RD	5	1	1	2,0	3,0	1

OPTIONALS

Part No.	LIQUID SEPARATOR	PLUGS
	Pag. 58	Pag. 57
8406001		
8406007		
8406003		
8406009		
8406005		
8406011		

Obbligatorio ordinare il cavo C4 separatamente.
Compulsory: cable C4 to be ordered separately.
Обязательно: заказывать кабель C4 отдельно.

C4 - END CABLE

L = 3,0 m Part No.	L = 5,0 m Part No.
C00900006	C00900007
C00900006	C00900007
C00900008	C00900009
C00900008	C00900009
C00900010	C00900011
C00900010	C00900011

Pag. 47



PRESSURE GAUGE

Pag. 346



Compact 50 W

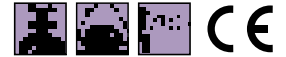

Scatole comando

A 2-3-5 sezioni.

****RD:** dove la valvola generale in OFF chiude automaticamente tutte le valvole di sezione.

***RI:** con valvole di sezione indipendenti.

Control boxes

With 2-3-5 section valves.

****RD:** with section valves controlled by the main valve.

***RI:** with independent section valves.

Блоки управления

С 2-3-5 секционными клапанами.

****RD:** при отключении главного клапана, автоматически отключаются все секционные клапаны.

***RI:** с независимыми секционными клапанами.

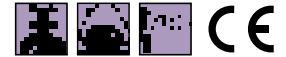

Campo di impiego / Use / Применение



FEATURES

kg	°C	V dc	A
~1	60	12	< 0,5

Part No.	Type	Section Valves V	Volumetric Valve P	Main Valve G	C1 L (m)	C2 L (m)	Pack
----------	------	---------------------	-----------------------	-----------------	-------------	-------------	------

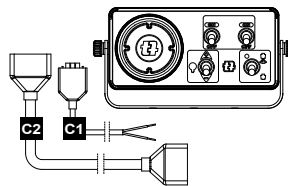

8406000 ***RI** 2 1 1 2,0 3,0 1

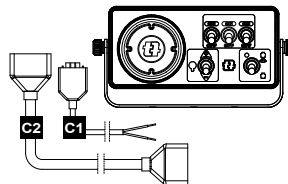

8406002 ***RI** 3 1 1 2,0 3,0 1

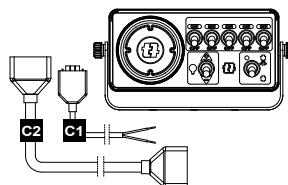

8406004 ***RI** 5 1 1 2,0 3,0 1

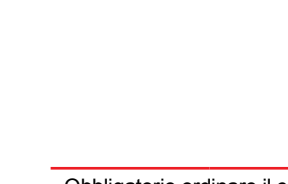

8406010 ****RD** 5 1 1 2,0 3,0 1

INSTALLATION

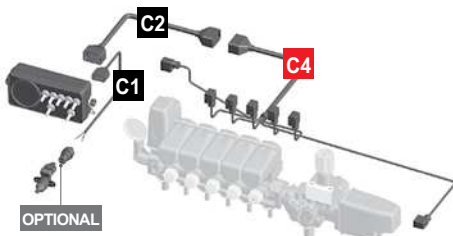

OPTIONALS

Part No.	LIQUID SEPARATOR	PLUGS
	Pag. 58	Pag. 57
8406000		
8406006		
8406002		
8406008		
8406004		
8406010		

Obbligatorio ordinare il cavo C4 separatamente.

Compulsory: cable C4 to be ordered separately.

Обязательно: заказывать кабель C4 отдельно.

C4 - END CABLE	
L = 3,0 m Part No.	L = 5,0 m Part No.
C00900006	C00900007
C00900006	C00900007
C00900008	C00900009
C00900008	C00900009
C00900010	C00900011
C00900010	C00900011

Pag. 47



Compact 10 W



Scatole di comando compatte dotate di fissaggio orientabile, led di controllo e fusibile generale di protezione. Offrono una soluzione affidabile e conveniente laddove sono necessari ingombri ridotti.

Adatte per il comando di valvole di sezione.

***RI:** con valvole di sezione indipendenti.

Compact control boxes with adjustable mounting system, working led and main safety fuse. A reliable and convenient solution where a compact size box is needed.

Suitable for controlling section valves.

***RI:** with independent section valves.

Компактные блоки управления, оснащенные регулируемым креплением, контрольным светодиодом и главным защитным плавким предохранителем. Представляют собой надежное и экономичное решение там, где необходимы компактные габариты.

Пригодны для управления секционными клапанами.

***RI:** с независимыми секционными клапанами.

Campo di impiego Use / Применение

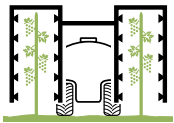

FEATURES

kg	°C	V dc
~1	60	12

INSTALLATION

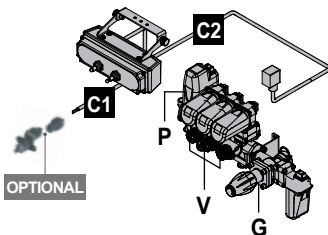

Part No.	Type	Section Valves	Volumetric Valve	Main Valve	C1	C2	Pack
		V	P	G	L (m)	L (m)	
8406067	Compact 10 W 1V *RI	1	-	-	2,0	4,0	1
8406068	Compact 10 W 2V *RI	2	-	-	2,0	4,0	1
8406069	Compact 10 W P+G *RI	-	1	1	2,0	4,0	1
NEW 8406088	Compact 10 W 2V+P+G *RI	2	1	1	2,0	4,0	1
NEW 8406087	Compact 10 W 2V+P+G **RD	2	1	1	2,0	4,0	1

Compact 10 W



Scatole di comando compatte dotate di fissaggio orientabile, led di controllo e fusibile generale di protezione. Offrono una soluzione affidabile e conveniente laddove sono necessari ingombri ridotti.

Compact control boxes with adjustable mounting system, working led and main safety fuse. A reliable and convenient solution where a compact size box is needed.

Компактные блоки управления, оснащенные регулируемым креплением, контрольным светодиодом и главным защитным плавким предохранителем. Представляют собой надежное и экономичное решение там, где необходимы компактные габариты. Пригодны для управления секционными клапанами.

Adatte per il comando di valvole di sezione.

Suitable for controlling section valves.

*RI: con valvole di sezione indipendenti.

*RI: with independent section valves.

**RD: dove la valvola generale in OFF chiude automaticamente tutte le valvole di sezione..

**RD: with section valves controlled by the main valve.

*RI: с независимыми секционными клапанами.
**RD: при отключении главного клапана, автоматически отключаются все секционные клапаны.

Campo di impiego Use / Применение



FEATURES

kg	°C	V dc
~1	60	12

INSTALLATION

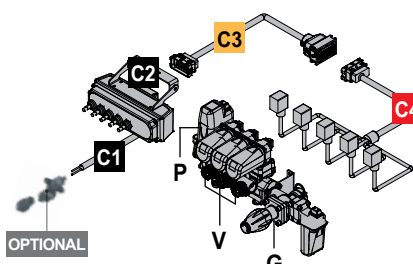

OPTIONAL

Part No.	Type	Section Valves	Volumetric Valve	Main Valve	C1	C2	Pack
		V	P	G	L (m)	L (m)	
8406070	Compact 10 W 2V+P *RI	2	1	-	2,0	0,3	1
8406077	Compact 10 W 3V *RI	3	-	-	2,0	0,3	1
8406071	Compact 10 W 2V+P+G *RI	2	1	1	2,0	0,3	1
8406079	Compact 10 W 2V+P+G **RD	2	1	1	2,0	0,3	1
8406072	Compact 10 W 4V+P+G *RI	4	1	1	2,0	0,3	1
8406080	Compact 10 W 4V+P+G **RD	4	1	1	2,0	0,3	1
8406073	Compact 10 W 7V+P+G *RI	7	1	1	2,0	0,3	1

OPTIONALS

COMPACT 10 W Part No.	C3 - EXTENSION CABLE		
	L = 3,0 m Part No.	L = 5,0 m Part No.	L = 7,0 m Part No.
8406070	> C00902014	> C00902015	> C00902030
8406071	> C00902014	> C00902015	> C00902030
8406079	> C00902014	> C00902015	> C00902030
8406077	> C00902014	> C00902015	> C00902030
8406072	> C00902014	> C00902015	> C00902030
8406080	> C00902014	> C00902015	> C00902030
8406073	> C00902016	> C00902017	> C00902030

Pag. 51-52



Obbligatorio ordinare il cavo C4 separatamente.

Compulsory: cable C4 to be ordered separately.

Обязательно: заказывать кабель C4 отдельно.

C4 - END CABLE

Pag. 46-47

L = 3,0 m Part No.	L = 5,0 m Part No.
> C00902008	> C00902011
> C00902008	> C00902011
> C00902158	> C00902159
> C00902009	> C00902012
> C00902009	> C00902012
> C00902010	> C00902013



Compact 15 H



Scatole di comando compatte dotate di fissaggio orientabile, led di controllo e fusibile generale di protezione. Offrono una soluzione affidabile e conveniente laddove sono necessari ingombri ridotti.

Compact control boxes with adjustable mounting system, working led and main safety fuse. A reliable and convenient solution where a compact size box is needed.

Компактные блоки управления, оснащенные регулируемым креплением, контрольным светодиодом и главным защитным плавким предохранителем. Представляют собой надежное и экономичное решение там, где необходимы компактные габариты.

Adatte per il comando di valvole movimenti idraulici.

Suitable for controlling hydraulic control valves.

Пригодны для управления гидравлическими клапанами.

Campo di impiego Use / Применение



Part No.	Type	Hydraulic Valves H	Switch ON Off	C1 L (m)	C2 L (m)	Pack
----------	------	-----------------------	---------------------	-------------	-------------	------

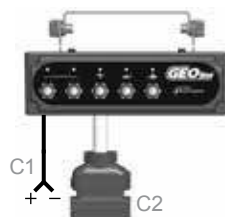

8406054	Compact 15 H 3+2	3+2	-	2,0	0,3	1
---------	------------------	-----	---	-----	-----	---

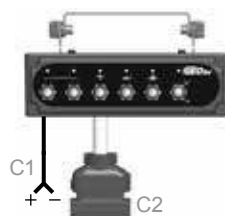

8406083	Compact 15 H 3+2	3+2	✓	2,0	0,3	1
---------	------------------	-----	---	-----	-----	---

NEW

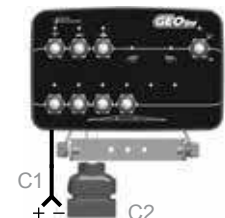

8406092	Compact 15 H 3+4	3+4	Lock led status	2,0	0,3	1
---------	------------------	-----	-----------------	-----	-----	---

FEATURES

kg	°C	V dc
~1	60	12

INSTALLATION

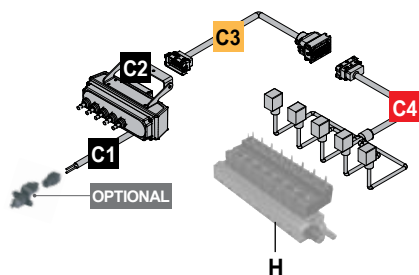

OPTIONALS

COMPACT 15 H Part No.
8406054
8406083
8406092

C3 - EXTENSION CABLE
L = 5,0 m Part No.
C00902045
C00902045
C00902045

Pag. 52



Obbligatorio ordinare il cavo C4 separatamente.
Compulsory: cable C4 to be ordered separately.
Обязательно: заказывать кабель C4 отдельно.

C4 - END CABLE	
L = 3,0 m Part No.	L = 5,0 m Part No.
C00902039	C00902042
C00902039	C00902042
/	C00902197

Pag. 46



Compact 20 W-SOL



Scatole di comando compatte dotate di fissaggio orientabile, led di controllo e fusibile generale di protezione. Offrono una soluzione affidabile e conveniente laddove sono necessari ingombri ridotti.

Compact control boxes with adjustable mounting system, working led and main safety fuse. A reliable and convenient solution where a compact size box is needed.

Компактные блоки управления, оснащенные регулируемым креплением, контрольным светодиодом и главным защитным плавким предохранителем. Представляют собой надежное и экономичное решение там, где необходимы компактные габариты.

Adatte per il comando di valvole di sezione a solenoide.

Suitable for controlling section valves with solenoid.

Пригодны для управления секционными электромагнитными клапанами.

*RI: con valvole di sezione indipendenti.

*RI: with independent section valves.

**RD: dove la valvola generale in OFF chiude automaticamente tutte le valvole di sezione.

**RD: with section valves controlled by the main valve.

*RI: с независимыми секционными клапанами.
**RD: при отключении главного клапана, автоматически отключаются все секционные клапаны.

Campo di impiego Use / Применение



Part No.	Type	Section Valves V	Volumetric Valve P	Main Valve G	C1 L (m)	C2 L (m)	Pack
----------	------	---------------------	-----------------------	-----------------	-------------	-------------	------

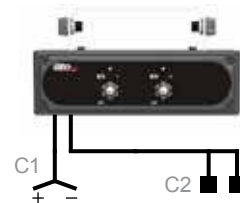

8406074	Compact 20 W-SOL 2V *RI	2	-	-	2,0	4,0	1
---------	-----------------------------------	---	---	---	-----	-----	---

NEW

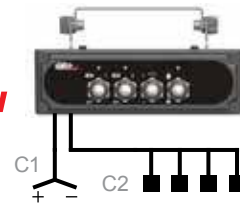

8406091	Compact 20 W-SOL 4V *RI	4	-	-	2,0	4,0	1
---------	-----------------------------------	---	---	---	-----	-----	---

FEATURES

kg	°C	V dc
~1	60	12

NEW

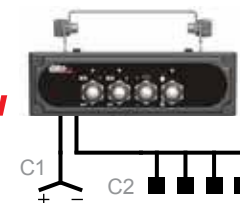

8406089	Compact 20 W-SOL 2V+P+G *RI	2	1	1	2,0	4,0	1
---------	---------------------------------------	---	---	---	-----	-----	---

8406090	Compact 20 W-SOL 2V+P+G **RD	2	1	1	2,0	4,0	1
---------	--	---	---	---	-----	-----	---

INSTALLATION

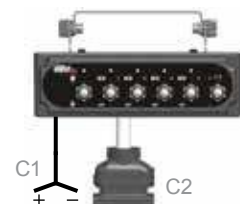
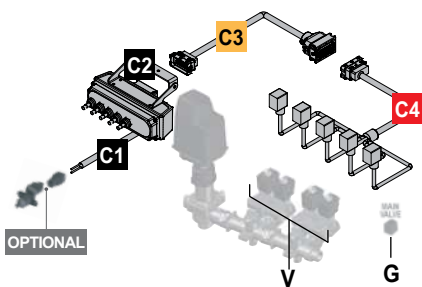

8406076	Compact 20 W-SOL 4V+P+G *RI	4	1	1	2,0	0,3	1
---------	---------------------------------------	---	---	---	-----	-----	---

8406082	Compact 20 W-SOL 4V+P+G **RD	4	1	1	2,0	0,3	1
---------	--	---	---	---	-----	-----	---

OPTIONALS

COMPACT 20 W-SOL Part No.	C3 - EXTENSION CABLE		
	L = 3,0 m Part No.	L = 5,0 m Part No.	L = 7,0 m Part No.
8406076	C00902014	C00902015	C00902030
8406082	C00902014	C00902015	C00902030

Pag. 51-52



Obbligatorio ordinare il cavo C4 separatamente.
Compulsory: cable C4 to be ordered separately.
Обязательно: заказывать кабель C4 отдельно.

C4 - END CABLE

L = 3,0 m Part No.	L = 5,0 m Part No.
C00902019	C00902021
C00902019	C00902021

Pag. 46





END CABLES

Compact 10 W

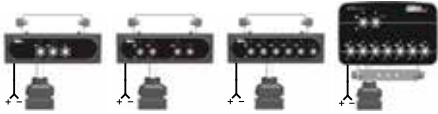

Compact 15 H

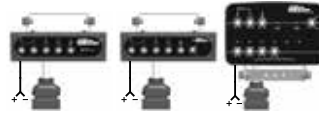

Compact 20 W-SOL

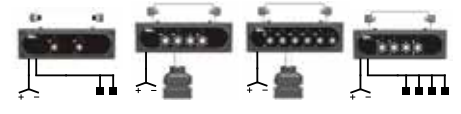

Part No.	Type	Suitable for	Pack
C00902008 C4	Cavo collegamento: Compact 10 W - Valvole di sezione <i>Connecting cable: Compact 10 W - Section valves</i> <i>Соединительный кабель: Compact 10 W - Секционные клапаны</i>	2V+P+G L = 3,0 m	COMPACT 10 W 1
C00902158 C4	Cavo collegamento: Compact 10 W - Valvole di sezione <i>Connecting cable: Compact 10 W - Section valves</i> <i>Соединительный кабель: Compact 10 W - Секционные клапаны</i>	3V L = 3,0 m	COMPACT 10 W 1
C00902009 C4	Cavo collegamento: Compact 10 W - Valvole di sezione <i>Connecting cable: Compact 10 W - Section valves</i> <i>Соединительный кабель: Compact 10 W - Секционные клапаны</i>	4V+P+G L = 3,0 m	COMPACT 10 W 1
C00902010 C4	Cavo collegamento: Compact 10 W - Valvole di sezione <i>Connecting cable: Compact 10 W - Section valves</i> <i>Соединительный кабель: Compact 10 W - Секционные клапаны</i>	7V+P+G L = 3,0 m	COMPACT 10 W 1
C00902011 C4	Cavo collegamento: Compact 10 W - Valvole di sezione <i>Connecting cable: Compact 10 W - Section valves</i> <i>Соединительный кабель: Compact 10 W - Секционные клапаны</i>	2V+P+G L = 5,0 m	COMPACT 10 W 1
C00902159 C4	Cavo collegamento: Compact 10 W - Valvole di sezione <i>Connecting cable: Compact 10 W - Section valves</i> <i>Соединительный кабель: Compact 10 W - Секционные клапаны</i>	3V L = 5,0 m	COMPACT 10 W 1
C00902012 C4	Cavo collegamento: Compact 10 W - Valvole di sezione <i>Connecting cable: Compact 10 W - Section valves</i> <i>Соединительный кабель: Compact 10 W - Секционные клапаны</i>	4V+P+G L = 5,0 m	COMPACT 10 W 1
C00902013 C4	Cavo collegamento: Compact 10 W - Valvole di sezione <i>Connecting cable: Compact 10 W - Section valves</i> <i>Соединительный кабель: Compact 10 W - Секционные клапаны</i>	7V+P+G L = 5,0 m	COMPACT 10 W 1
C00902039 C4	Cavo collegamento: Compact 15 H - Valvole idrauliche <i>Connecting cable: Compact 15 H - hydraulic valves</i> <i>Соединительный кабель: Compact 15 H - Гидравлические клапаны</i>	5V+G 11 Connect. L = 3,0 m	COMPACT 15 H 1
C00902042 C4	Cavo collegamento: Compact 15 H - Valvole idrauliche <i>Connecting cable: Compact 15 H - hydraulic valves</i> <i>Соединительный кабель: Compact 15 H - Гидравлические клапаны</i>	5V+G 11 Connect. L = 5,0 m	COMPACT 15 H 1
C00902197 C4	Cavo collegamento: Compact 15 H - Valvole idrauliche - Tracciafile <i>Connecting cable: Compact 15 H - hydraulic valves - Foam marker</i> <i>Соединительный кабель: Compact 15 H - Гидравлические клапаны - Пенные маркеры</i>	5V+G L = 5,0 m	COMPACT 15 H 1
C00902018 C4	Cavo collegamento: Compact 20 W - Valvole di sezione a solenoide <i>Connecting cable: Compact 20 W - Solenoid section valves</i> <i>Соединительный кабель: Compact 20 W - Секционные электромагнитные клапаны</i>	2V+P L = 3,0 m	COMPACT 20 W-SOL 1
C00902019 C4	Cavo collegamento: Compact 20 W - Valvole di sezione a solenoide <i>Connecting cable: Compact 20 W - Solenoid section valves</i> <i>Соединительный кабель: Compact 20 W - Секционные электромагнитные клапаны</i>	4V+P+G L = 3,0 m	COMPACT 20 W-SOL 1
C00902020 C4	Cavo collegamento: Compact 20 W - Valvole di sezione a solenoide <i>Connecting cable: Compact 20 W - Solenoid section valves</i> <i>Соединительный кабель: Compact 20 W - Секционные электромагнитные клапаны</i>	2V+P L = 5,0 m	COMPACT 20 W-SOL 1
C00902021 C4	Cavo collegamento: Compact 20 W - Valvole di sezione a solenoide <i>Connecting cable: Compact 20 W - Solenoid section valves</i> <i>Соединительный кабель: Compact 20 W - Секционные электромагнитные клапаны</i>	4V+P+G L = 5,0 m	COMPACT 20 W-SOL 1



END CABLES

Compact 50 WM



Compact 50 W



Part No.		Type		Suitable for	Pack		
C00900006	C4	Cavo di completamento End cable Конечный кабель	L = 3,0 m (10 feet)	2 Section Valves	COMPACT 50 WM COMPACT 50 W		1
C00900007	C4	Cavo di completamento End cable Конечный кабель	L = 5,0 m (16,5 feet)				1
C00900008	C4	Cavo di completamento End cable Конечный кабель	L = 3,0 m (10 feet)	3 Section Valves	COMPACT 50 WM COMPACT 50 W		1
C00900009	C4	Cavo di completamento End cable Конечный кабель	L = 5,0 m (16,5 feet)				1
C00900010	C4	Cavo di completamento End cable Конечный кабель	L = 3,0 m (10 feet)	5 Section Valves	COMPACT 50 WM COMPACT 50 W		1
C00900011	C4	Cavo di completamento End cable Конечный кабель	L = 5,0 m (16,5 feet)				1

Sensore di pressione

Pressure sensor

Датчик давления



Part No.	L (m)	bar	mA	V dc	Pack
S02000026		20			
S02000010	5,0	50	4-20	12	1
S02000011		100			

Adatto per / Suitable to / Предусмотрен для

GS 250 GS 260 GS 200

Cavo adattatore sensore di pressione

Pressure sensor adapter cable

Кабель с адаптером датчика давления



Part No.	L (m)	V dc	Pack
C00902029	0,5	12	1

Adatto per / Suitable to / Предусмотрен для

GS 250 GS 260

Sensore di livello completo di supporto per fissaggio

Level sensor complete with mounting bracket

Уровневый датчик с монтажным кронштейном



Part No.	V dc	Pack
K00004002	12	1

Adatto per / Suitable to / Предусмотрен для

GS 250 GS 260 GS 200

Cavo collegamento Sensore di livello GS 200

Level sensor connecting cable GS 200

Соединительный кабель уровневого датчика GS 200



Part No.	L (m)	V dc	Pack
C00902035	5,0	12	1

Adatto per / Suitable to / Предусмотрен для

GS 200

Cavo collegamento Sensore di livello - Driver Box *Level sensor-Driver Box connecting cable*

Соединительный кабель *уровневого датчика - Driver Box*



Part No.	L (m)	V dc	Pack
C00902046	5,0	12	1

Adatto per / Suitable to / Предусмотрен для

GS 250 GS 260 GS 200

Cavo adattatore sensore di livello

Level sensor adapter cable

Кабель с адаптером уровневого датчика



Part No.	L (m)	V dc	Pack
C00902028	0,5	12	1

Adatto per / Suitable to / Предусмотрен для

GS 250 GS 260 GS 200

Cavo collegamento Monitor - Driver Box W

Monitor-Driver Box W connecting cable

Соединительный кабель дисплея- Driver Box W



Part No.	L (m)	V dc	Pack
C00902002	11,0	12	1

Adatto per / Suitable to / Предусмотрен для

GS 250 GS 260

Cavo connessione GS 200

GS 200 connecting cable

Соединительный кабель GS 200



Part No.	No. Sensor	Type	L (m)	V dc	Pack
C00902036	1	D	2,0	12	1
C00902037	2	A+D			
C00902058	2	D+D			
C00902038	4	2A+2D			

Sensor Type Connector

Pressure	A	Analogic
Level		
Flow	D	Digital
Speed		

Adatto per / Suitable to / Предусмотрен для

GS 200

Cavo collegamento valvole: Sezione, Generale, Proporzionale

Connecting cable to valves: Section, General, Proportional

Соединительный кабель клапанов: секционного, главного, пропорционального



Part No.	L (m)	V dc	Pack
C00902001	6,0	12	1
C00902000	10,0	12	1

Adatto per / Suitable to / Предусмотрен для

GS 250 GS 260

Cavo collegamento: Compact 10 W - Valvole di sezione

Connecting cable: Compact 10 W - Section valves

Соединительный кабель: Compact 10 W - Секционные клапаны



Part No.	Type	L (m)	V dc	Pack
C00902008	2V+P+G			
C00902009	4V+P+G	3,0	12	1
C00902010	7V+P+G			
C00902011	2V+P+G			
C00902012	4V+P+G	5,0	12	1
C00902013	7V+P+G			

Adatto per / Suitable to / Предусмотрен для

Compact 10 W

Cavo collegamento: Compact 15 H - Valvole idrauliche - Tracciafile

Connecting cable: Compact 15 H - hydraulic valves - Foam marker

Соединительный кабель: Compact 15 H - Гидравлические клапаны - Пенные маркеры



Part No.	Type	L (m)	V dc	Pack
C00902040	2V 4 Connect.	3,0	12	1
C00902041	4V 8 Connect.			
C00902043	2V 4 Connect.	5,0	12	1
C00902044	4V 8 Connect.			

Adatto per / Suitable to / Предусмотрен для

Compact 15 H

Cavo collegamento: Compact 15 H - Valvole idrauliche

Connecting cable: Compact 15 H - hydraulic valves

Соединительный кабель: Compact 15 H - Гидравлические клапаны



Part No.	Type	L (m)	V dc	Pack
C00902039	5V+G	3,0	12	1
C00902042	11 Connect.	5,0	12	1

Adatto per / Suitable to / Предусмотрен для

Compact 15 H (2+3)

Cavo collegamento: Compact 20 W - Valvole di sezione a solenoide

Connecting cable: Compact 20 W - Solenoid section valves

Соединительный кабель: Compact 20 W - Секционные электромагнитные клапаны



⚡

Part No.	Type	L (m)	V dc	Pack
C00902018	2V+P	3,0	12	1
C00902019	4V+P+G			
C00902020	2V+P	5,0	12	1
C00902021	4V+P+G			

Adatto per / Suitable to / Предусмотрен для

Compact 20 W-SOL

Prolunga per cavo collegamento Monitor - Driver Box W

Extension for Monitor-Driver Box W connecting cable

Удлинитель для соединительного кабеля дисплея - Driver Box W



⚡

Part No.	L (m)	V dc	Pack
C00902022	3,0	12	1
C00902005	5,0	12	1

Adatto per / Suitable to / Предусмотрен для

GS 250 GS 260

Prolunga per cavo collegamento Monitor - Driver Box H

Extension for Monitor-Driver Box H connecting cable

Удлинитель для соединительного кабеля дисплея - Driver Box H



⚡

Part No.	L (m)	V dc	Pack
C00902003	3,0	12	1
C00902004	5,0	12	1

Adatto per / Suitable to / Предусмотрен для

GS 250 GS 260

Prolunga per cavo collegamento valvole + sensore

Extension for valves + sensor connecting cable

Удлинитель для соединительного кабеля клапанов + датчика



⚡

Part No.	Type	L (m)	V dc	Pack
C00902016	M-F 2/4V+P+G	3,0	12	1
C00902017	M-F 24P	5,0	12	1
C00902030	M-F 24P	7,0	12	1

Adatto per / Suitable to / Предусмотрен для

GS 240 Compact 10 W

Prolunga per collegamento Compact 10 W -
Cavo valvole sezione.

Extension for Compact 10 W -
Cable for section valve.

Удлинитель для соединения Compact 10 W -
Кабель секционных клапанов.



Part No.	Type	L (m)	V dc	Pack
C00902014	M-F	3,0	12	1
C00902015	6 Switches	5,0	12	1

Adatto per / Suitable to / Предусмотрен для

Compact 10 W Compact 20 W-SOL

Prolunga per cavo collegamento Compact 15 H -
Driver Box H

Extension for Compact 15 H + Driver Box H
connecting cable

Удлинитель для соединительного кабеля
Compact 15 H - Driver Box H



Part No.	Type	L (m)	V dc	Pack
C00902045	M-F	5,0	12	1

Adatto per / Suitable to / Предусмотрен для

Compact 15 H

Antenna GPS

Fornisce ai computer Geosystem un accurato calcolo della posizione e precisa misura della velocità, evitando l'installazione del sensore di prossimità sulla ruota

- Calcolo della posizione attraverso i segnali GPS, GLONASS, GALILEO, QZSS;
- Compatibile con i segnali di correzione SBAS (WAAS, EGNOS, MSAS, GAGAN);
- Supporta 99 canali GNSS;
- Aggiornamento della posizione 10 volte al secondo (10 HZ);
- Basso consumo energetico;
- Indicatore led della posizione;
- Magneti incorporati per una rapida installazione;
- Waterproof;
- Cablaggio semplificato;
- Disponibile per i computer Geosystem 260;
- +12 [V]

GPS antenna

It provides to Geosystem computer an accurate calculation of position and a speed measure, in order to avoid the proximity sensor installed on the wheel.

- Support GPS, GLONASS, GALILEO and QZSS;
- Capable of SBAS (WAAS, EGNOS, MSAS, GAGAN);
- Support 99-channel GNSS;
- Up to 10Hz update rate;
- Ultra low power consumption;
- Led indicator of position status;
- Built-in magnets for a quick installation;
- Waterproof;
- Quick cabling;
- Available for computer Geosystem 260;
- +12 [V]

Антенна GPS

Передаёт на компьютер Geosystem точные расчёты по позиции и скорости, тем самым снимая необходимость в установке бесконтактного датчика на колесе.

- Расчёт позиции при помощи сигналов GPS, GLONASS, GALILEO, QZSS;
- Совместима с сигналами коррекции SBAS (WAAS, EGNOS, MSAS, GAGAN);
- Поддерживает 99 каналов GNSS;
- Частота обновления данных о позиции -10 раз в секунду (10 Гц);
- Низкое энергопотребление;
- Световой указатель позиции;
- Встроенные магниты для облегчения монтажа;
- Водонепроницаемая;
- Упрощённая электрообвязка;
- Совместима с компьютером Geosystem 260;
- +12 [В]



Part No.	L (m)	V dc	Pack
A01100002	3,0	12	1

Adatto per / Suitable to / Предусмотрен для

GS 260

Cavo di collegamento per Geosystem 260 con navigatore GPS esterno tramite protocollo T.U.V.R. T.U.V.R. è un protocollo esclusivo **Trimble®** per il controllo delle attrezzature.
Consente l'apertura e chiusura automatica delle sezioni di barra in base alle indicazioni del navigatore GPS esterno **Trimble®**.

Connection cable for Geosystem 260 with external GPS satnav via T.U.V.R. protocol
T.U.V.R. is an exclusive **Trimble®** control protocol. It allows automatic opening and closing of bar sections on the basis of the external **Trimble®** GPS navigator.

Кабель соединения для Geosystem 260 с внешним GPS-навигатором через протокол TUVR. TUVR - это эксклюзивный протокол **Trimble®** для управления устройствами. Позволяет производить автоматическое открытие и закрытие секций штанги в зависимости от указаний внешнего GPS-навигатора **Trimble®**.



Part No.	L (m)	Pack
----------	-------	------

C00902149	2	1
-----------	---	---

Adatto per / Suitable to / Предусмотрен для

GS 260 CS GS 260 CS H

Staffa ventosa con sfera + Supporto a sfera per fissaggio monitor

Suction cup bracket with ball + Monitor holder with ball

Кронштейн на присоске со сферой + Суппорт со сферой для крепления дисплея



Part No.	Pack
----------	------

V00700001	1
-----------	---

Adatto per / Suitable to / Предусмотрен для

GS 260 GS 250

Staffa da palo con sfera (senza braccio di completamento)

Pole bracket with ball (without supplementary arm)

Кронштейн на опоре со сферой (без дополнительного рычага)

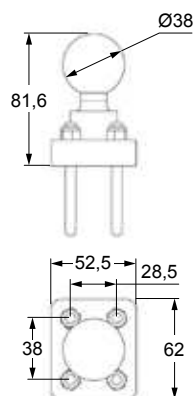

Part No.	Pack
----------	------

S00400063	1
-----------	---

Adatto per / Suitable to / Предусмотрен для

GS 260 GS 250

Staffa da palo + Braccio + Supporto a sfera per fissaggio monitor

Pole bracket + Arm + Monitor holder with ball

Кронштейн на опоре + Рычаг + Суппорт со сферой для крепления дисплея



Part No. Pack

K00701010 1

Adatto per / Suitable to / Предусмотрен для

GS 260 GS 250

Braccio + Supporto a sfera per fissaggio monitor

Arm + Monitor holder with ball

Рычаг + Суппорт со сферой для крепления дисплея



Part No. Pack

K00701011 1

Adatto per / Suitable to / Предусмотрен для

GS 260 GS 250

Supporto a sfera per fissaggio monitor

Monitor holder with ball

Суппорт со сферой для крепления дисплея

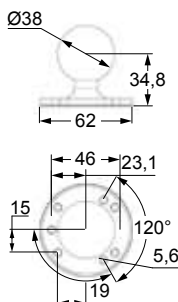

Part No. Pack

S00400064 1

Adatto per / Suitable to / Предусмотрен для

GS 260 GS 250

Staffa ventosa con sfera

Suction cup bracket with ball

Кронштейн на присосе со сферой

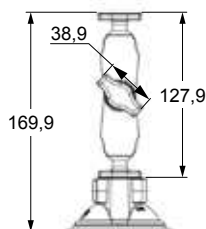

Part No. Pack

V00700002 1

Adatto per / Suitable to / Предусмотрен для

GS 200

Staffa da palo + Braccio + Supporto a sfera per fissaggio monitor

Pole bracket + Arm + Monitor holder with ball

Кронштейн на опоре + Рычаг + Суппорт со сферой для крепления дисплея

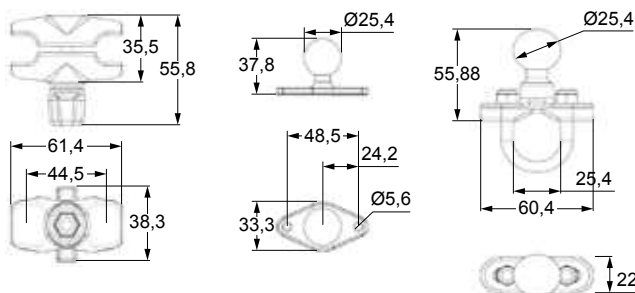

Part No.	Pack
K00701012	1

Adatto per / Suitable to / Предусмотрен для

GS 200

Staffa da palo + Braccio + Supporto a sfera per fissaggio monitor

Pole bracket + Arm + Monitor holder with ball

Кронштейн на опоре + Рычаг + Суппорт со сферой для крепления дисплея

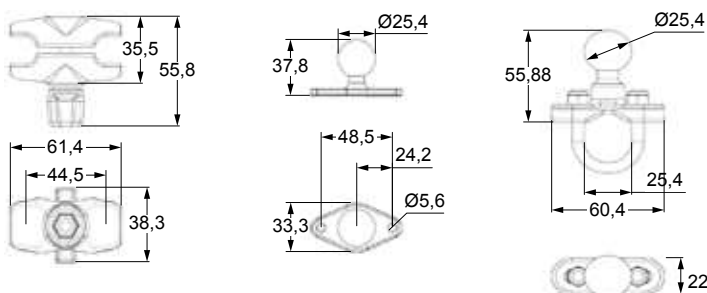

Part No.	Pack
K00701013	1

Adatto per / Suitable to / Предусмотрен для

GS 200

Kit per il collegamento di un tracciabile ad un computer o ad una scatola idraulica di comando. Stop pompa GS200.

Wiring kit to connect a foam marker to a computer or to a hydraulic control box. "Pump stop" GS200.

Комплект для подсоединения пенного маркера к компьютеру или гидравлическому блоку управления. Функция "остановка насоса" GS200.



Part No.	°C	V dc	Pack
8394016	60	12	1

Adatto per / Suitable to / Предусмотрен для

GS 260 CS GS 250 CS GS 200
GS 260 CS H GS 250 CS H

Cavo collegamento monitor

Monitor connecting cable

Соединительный кабель дисплея



Part No.	L (m)	Pack
C00902199	5,0	1
C00902203	10,0	1

Adatto per / Suitable to / Предусмотрен для

GeoNave 31

Cavo collegamento valvole

Valves connecting cable

Соединительный кабель клапанов



Part No.	Type	V dc	Pack
C00902201	5W+P+G+FL	12	1
C00902205	9W+P+G+FL		

Adatto per / Suitable to / Предусмотрен для

GeoNave 31

Cavo connessione e alimentazione ISOBUS
SPRAYER ECU 1224.

ISOBUS SPRAYER ECU 1224 connection and
power cable.

Соединительный кабель и питания ISOBUS
SPRAYER ECU 1224.



Part No.	L (m)	Pack
C00902177	5	1
C00902169	10	1

Adatto per / Suitable to / Предусмотрен для

ISOBUS SPRAYER ECU 1224

Sensore sonar

Sonar sensor

Датчик sonar



Measurement
range

Part No.	(m)	Pack
S02000032	0,35+5	1
S02000031	0,6+6	1

Adatto per / Suitable to / Предусмотрен для

GS 190S

Supporto sensore sonar

Sonar sensor support

Суппорт датчика sonar



Part No. Pack

K00112018 1

Adatto per / Suitable to / Предусмотрен для

GS 190S

Presaspina di alimentazione

Power socket-plug

Силовая розетка-вилка



Part No. Type Pack

K00102040 2 PIN 1

K00102044 3 PIN 1

Adatto per / Suitable to / Предусмотрен для

Compact 50 WM Compact 50 W

Compact 10 W Compact 15 H Compact 20 W-SOL

Spina alimentazione accendisigari

Cigarette lighter power plug

Силовая вилка для прикуривателя



Part No. Pack

S00800001 1

Adatto per / Suitable to / Предусмотрен для

Compact 50 WM Compact 50 W

Compact 10 W Compact 15 H Compact 20 W-SOL

Separatore di liquidi

Consente l'uso del manometro in cabina senza la presenza di prodotti chimici. Il riempimento puo essere fatto con glicerina o acqua. Puo essere utilizzato con qualsiasi tipo di scatole comando.

- Corpo in acciaio inox 303
- Particolari in alluminio Anticorodal
- Membrana in viton di serie
- Grano di spurgo in acciaio inox
- Disponibile con filettature NPT e BSP

Liquid separator

Allows the use of pressure gauge without chemicals in the cab . Refilling may be done with glycerin or water. It may be used with any kind of control units.

- 303 Inox Body
- Anticorodal aluminium parts
- Viton Diaphragm as standard
- Drain-off in stainless steel
- Available with NPT or BSP threads

Жидкостный сепаратор

Позволяет использовать манометр в кабине без наличия химических средств. Может заполняться глицерином или водой. Может использоваться с любыми блоками управления.

- Корпус из нержавеющей стали 303
- Детали из алюминия антикорродал
- Мембрана из витона стандартной комплект.
- Спускной винт из нержавеющей стали
- Предусмотрен с резьбой NPT или BSP .

INSTALLATION

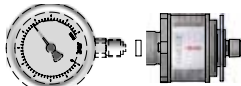

Non compreso nel kit.
Not included.
Не входит в комплектацию.



Part No.	F1	F2	bar	Pack
8392064	G 1/4 F	G 1/4 M		1
8392065	1/4 NPT F	1/4 NPT M	20	1
8392066	G 1/8 F	G 1/8 M		1
8392067	1/8 NPT F	1/8 NPT M		1

INSTALLATION

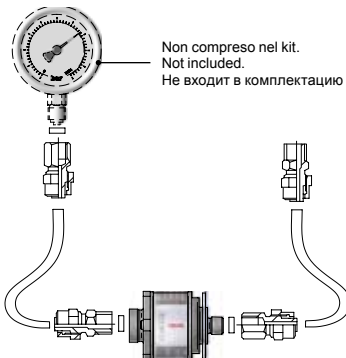

Non compreso nel kit.
Not included.
Не входит в комплектацию



Part No.	F1	F2	bar	Pack
8392068	G 1/4 F	G 1/4 M	20	1
8392070	G 1/8 F	G 1/8 M		1

-Il kit è completo di tubo in rilsan , di raccordi e di ampolla per il caricamento.
-This kit comes complete with Rilsan pipe, fittings and bottle for refilling.
-В комплект входит труба из рилсана, соединения и баллон для заполнения.







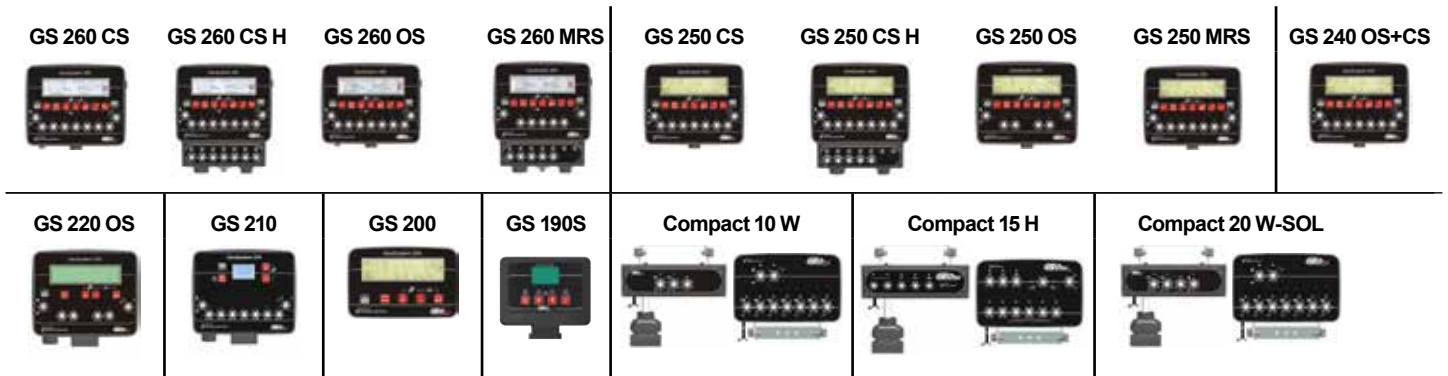









Part No.	F1	F2	bar	Pack
8392069	1/4 NPT F	1/4 NPT M	20	1
8392071	1/8 NPT F	1/8 NPT M		1

SPARE PARTS



Part No.	Description	Type	Suitable for	Pack
D00601000	Scatola di derivazione Driver Box W <i>Connecting box: Driver Box W</i> <i>Соединительная коробка Driver Box W</i>	3W	GS 250 CS GS 250 CS H GS 250 OS GS 250 MRS	1
D00601002	Scatola di derivazione Driver Box W <i>Connecting box: Driver Box W</i> <i>Соединительная коробка Driver Box W</i>	5W	GS 260 CS GS 260 CS H GS 260 OS	1
D00601003	Scatola di derivazione Driver Box W <i>Connecting box: Driver Box W</i> <i>Соединительная коробка Driver Box W</i>	7W	GS 260 MRS GS 260 MRS H	1
D00601008	Scatola di derivazione Driver Box H <i>Connecting box: Driver Box H</i> <i>Соединительная коробка Driver Box H</i>	2H		1
D00601009	Scatola di derivazione Driver Box H <i>Connecting box: Driver Box H</i> <i>Соединительная коробка Driver Box H</i>	5H	GS 250 CS H GS 260 CS H GS 260 MRS H	1
D00601010	Scatola di derivazione Driver Box H <i>Connecting box: Driver Box H</i> <i>Соединительная коробка Driver Box H</i>	7H		1
D00601011	Scatola di derivazione Driver Box H <i>Connecting box: Driver Box H</i> <i>Соединительная коробка Driver Box H</i>	9H		1
D00602000	Scatola di derivazione Driver Box Compact 15 H <i>Connecting box: Driver Box H</i> <i>Соединительная коробка Driver Box H</i>	7-9H	Compact 15 H	1
C00902006	Cavo collegamento Monitor - Driver Box W <i>Connecting cable Monitor - Driver Box W</i> <i>Соединительный кабель дисплея - Driver Box W</i>	L = 5,0 m	GS 250 GS 260	1
C00902007	Cavo collegamento Monitor - Driver Box H <i>Connecting cable Monitor - Driver Box H</i> <i>Соединительный кабель дисплея - Driver Box H</i>	L = 5,0 m	GS 250 CS H GS 260 CS H	1
C00902023	Cavo collegamento valvole: Sezione, Generale, Proporzionale <i>Connecting cable to valves: Section, Main, Proportional</i> <i>Соединительный кабель клапанов: секционного, главного, пропорционального</i>	L = 1,2 m	GS 250 GS 260	1
C00902024	Cavo collegamento valvole: Sezione, Generale, Proporzionale <i>Connecting cable to valves: Section, Main, Proportional</i> <i>Соединительный кабель клапанов: секционного, главного, пропорционального</i>	L = 1,2 m	GS 250 CS H GS 260 CS H	1
C00902025	Cavo collegamento valvola Sezione Oleodinamica <i>Connecting cable for hydraulic section valve</i> <i>Соединительный кабель секционного гидравлического клапана</i>	L = 1,2 m	GS 250 CS H GS 260 CS H	1

SPARE PARTS

Part No.	Description	Type	Suitable for	Pack
C00902026	Cavo collegamento tracciafile <i>Foam marker connecting cable</i> Соединительный кабель маркера пены	L = 0,4 m	GS 250 CS / CS H GS 260 CS / CS H	 1
C00902027	Cavo adattatore flussometro <i>Flow meter adapter cable</i> Кабель с адаптером расходомера	L = 0,5 m	GS 240 GS 250 GS 260	 1
C00902161	Cavo alimentazione valvole + sensori <i>Power cable for valves + sensors</i> Кабель питания клапанов + датчиков	L = 4,0 m	GS 190S	 1
S02000009	Sensore di velocita' <i>Speed sensor</i> Датчик скорости	L = 5,0 m	GS 260 GS 250 GS 220	 1
S02000031	Sensori sonar (range di rilevamento 6m) <i>Sonar sensors (measurement range 6m)</i> Датчики sonar (диапазон действия 6м)		GS 190S	 1
S02000032	Sensori sonar (range di rilevamento 3m) <i>Sonar sensors (measurement range 3m)</i> Датчики sonar (диапазон действия 3м)		GS 190S	 1
K00112018	Supporto sensore sonar <i>Sonar sensor support</i> Суппорт датчика sonar		GS 190S	 1
8388037	Elettrovalvola a solenoide MY20 <i>Electric Solenoid Valve MY20</i> Электромагнитный клапан MY20		GS 190S	 1
C00902030	Prolunga per cavo collegamento valvole + sensore <i>Extension for valves + sensor connecting cable</i> Удлинитель для соединительного кабеля клапанов + датчика	MF 24P L = 7,0 m	GS 210 GS 220 GS 240	 1
C00902017	Prolunga per cavo collegamento valvole + sensore <i>Extension for valves + sensor connecting cable</i> Удлинитель для соединительного кабеля клапанов + датчика	MF 24P L = 5,0 m	GS 210 GS 220 GS 240	 1
C00902016	Prolunga per cavo collegamento valvole + sensore <i>Extension for valves + sensor connecting cable</i> Удлинитель для соединительного кабеля клапанов + датчика	MF 24P L = 3,0 m	GS 210 GS 220 Compact 10 W	 1
C00902209	Cavo collegamento valvole + sensore <i>Connecting cable for valves + sensor</i> Соединительный кабель клапанов + датчика	2W L = 1,2 m	GS 240	 1
C00902210	Cavo collegamento valvole + sensore <i>Connecting cable for valves + sensor</i> Соединительный кабель клапанов + датчика	4W L = 1,2 m	GS 240	 1
C00902208	Cavo collegamento valvole + sensore <i>Connecting cable for valves + sensor</i> Соединительный кабель клапанов + датчика	3W L = 1,2 m	GS 240	 1
C00902108	Cavo collegamento valvole + sensore <i>Connecting cable for valves + sensor</i> Соединительный кабель клапанов + датчика	5W L = 1,2 m	GS 240	 1

SPARE PARTS

Part No.	Description	Type	Suitable for	Pack
C00902047	Cavo collegamento valvole + sensore <i>Connecting cable for valves + sensor</i> <i>Соединительный кабель клапанов + датчика</i>	2W 4Sens. L = 1,2 m	GS 220	1
C00902048	Cavo collegamento valvole + sensore <i>Connecting cable for valves + sensor</i> <i>Соединительный кабель клапанов + датчика</i>	4W 4Sens. L = 1,2 m	GS 220	1
C00902031	Cavo collegamento valvole + sensore <i>Connecting cable for valves + sensor</i> <i>Соединительный кабель клапанов + датчика</i>	2W+P +G 1 sens.	GS 210	1
C00902032	Cavo collegamento valvole + sensore <i>Connecting cable for valves + sensor</i> <i>Соединительный кабель клапанов + датчика</i>	3W+P +G input 1 sens.	GS 210	1
C00902033	Cavo collegamento valvole + sensore <i>Connecting cable for valves + sensor</i> <i>Соединительный кабель клапанов + датчика</i>	5W+P +G 1 sens.	GS 210	1
C00902034	Cavo collegamento valvole + sensore <i>Connecting cable for valves + sensor</i> <i>Соединительный кабель клапанов + датчика</i>	7W+P +G 1 sens.	GS 210	1
C00902170	Cavo collegamento valvole + sensore <i>Connecting cable for valves + sensor</i> <i>Соединительный кабель клапанов + датчика</i>	6W+P +G	ECU 1224 7W ECU 1224 9W	1
C00902171	Cavo collegamento valvole + sensore <i>Connecting cable for valves + sensor</i> <i>Соединительный кабель клапанов + датчика</i>	3W 2 sens.	ECU 1224 9W	1
C00902173	Cavo collegamento valvole + sensore <i>Connecting cable for valves + sensor</i> <i>Соединительный кабель клапанов + датчика</i>	5W+P +G	ECU 1224 5W	1
C00902175	Cavo collegamento valvole + sensore <i>Connecting cable for valves + sensor</i> <i>Соединительный кабель клапанов + датчика</i>	1W 2 sens.	ECU 1224 7W	1
C00902186	Cavo collegamento valvole + sensore <i>Connecting cable for valves + sensor</i> <i>Соединительный кабель клапанов + датчика</i>	10W+P +G	ECU 1224 11W ECU 1224 13W ECU 1224 16W	1
C00902187	Cavo collegamento valvole + sensore <i>Connecting cable for valves + sensor</i> <i>Соединительный кабель клапанов + датчика</i>	6W 2 sens.	ECU 1224 16W	1
C00902188	Cavo collegamento valvole + sensore <i>Connecting cable for valves + sensor</i> <i>Соединительный кабель клапанов + датчика</i>	3W 2 sens.	ECU 1224 13W	1
C00902189	Cavo collegamento valvole + sensore <i>Connecting cable for valves + sensor</i> <i>Соединительный кабель клапанов + датчика</i>	1W 2 sens.	ECU 1224 11W	1
S00400065	Staffa di fissaggio <i>Fixing support</i> <i>Крепежный кронштейн</i>		GS 260 GS 250 GS 210	1
K00112019	Staffa di fissaggio <i>Fixing support</i> <i>Крепежный кронштейн</i>		GS 200 GS 190S	1

Cavo di alimentazione elettrovalvole. Adatto per tutte le valvole serie NRG, a 2 fili.

Connecting cable for NRG series, 2 wire valves.

Кабель питания электромагнитных клапанов. Пригоден для всех 2-проводных клапанов серии NRG.



Part No.	°C	V dc	Pack
S00800000	60	12	1



Part No.	L (m)	°C	V dc	Pack
C00900003	2,1	60	12	1
C00902123	5,1			

Cavo di alimentazione per valvole elettriche a solenoide, completo di guarnizione e vite di fissaggio.
Dotato di led segnalazione valvola aperta.

Power supply cable for solenoid valves with fittings and screw.
Open valve led indicator included.

Силовой кабель для электромагнитных клапанов, в комплектации прокладкой и крепежным винтом.
Оснащен сигнальным светодиодом открытого клапана.



Part No.	L mm	°C	V dc	Pack
C00900021	1500	60	12	1

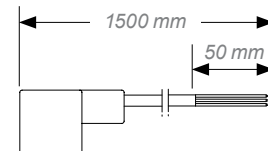









w w w . g e o l i n e . i t



LEGENDA





Campo di impiego / Use / Применение

	Per macchine a basso volume <i>For low-volume spraying machines</i> Для малообъемных опрыскивателей		Per atomizzatori <i>For orchard sprayers</i> Для распылителей		Per macchine da diserbo <i>For crop sprayers</i> Для штанговых опрыскивателей
	Componente modulare <i>Modular component</i> Модульный компонент		Adatto per computers GeoSystem <i>Suitable to computers GeoSystem</i> Пригоден для компьютеров GeoSystem		Sistema di comando senza fili <i>Wireless control system</i> Беспроводная система управления
	Adatto per distributori olio idraulico <i>Suitable to hydraulic oil distributors</i> Пригоден для распределителей гидравлического масла		Valvole di sezione serie NRG <i>Section valve NRG series</i> Секционные клапаны серии NRG		Valvole di sezione serie NRG PLUS <i>Section valve NRG PLUS series</i> Секционные клапаны серии NRG PLUS

Caratteristiche / Features / Характеристики

	Portata della pompa <i>Pump flow rate</i> Производительность насоса		Portata <i>Flow rate</i> Расход		Pressione d'esercizio <i>Operating pressure</i> Рабочее давление
	Temperatura max <i>Max temperature</i> Максимальная температура		Tensione di alimentazione <i>Working voltage</i> Напряжение питания		Tempo di azionamento <i>Operating time</i> Рабочее время
	Portagomma <i>Hosetail</i> Штуцер		Peso <i>Weight</i> Вес		Per testine attacco rapido <i>For quick fitting caps</i> Для головок быстрого подключения
	Assorbimento elettrico <i>Power consumption</i> Электропотребление				

Accessori da ordinare separatamente Accessories to be ordered separately Заказываемые отдельно аксессуары

	IN Portagomma di entrata valvole generali <i>Inlet hosetails for main valves</i> Входной штуцер для главных клапанов
	OUT Portagomma di uscita valvole di sezione <i>Outlet hosetails for section valves</i> Выходной штуцер для секционных клапанов
	BY-PASS Portagomma by-pass valvola generale <i>Hosetails by-pass for main valves</i> Байпасный штуцер для главных клапанов
	ADAPTERS Flange / Portagomma per valvole elettriche <i>Adapters / Hosetails for electric valves</i> Фланцы / Штуцеры для электроклапанов

Accessori opzionali Optionals Дополнительные аксессуары

	Manometri <i>Pressure gauges</i> Манометры
	Cavo di completamento <i>End cables</i> Концевой кабель
	Scatole di comando <i>Control boxes</i> Блоки управления
	Computers serie GeoSystem <i>Computers GeoSystem series</i> Компьютеры серии GeoSystem
	Kit assemblaggio valvole <i>Assembling kit for valves</i> Комплект для сборки клапанов
	Collettori / Portagomma / Tappi <i>Manifolds / Hosetails / Plugs</i> Коллекторы / Штуцеры / Заглушки
	Flange / Portagomma per valvole elettriche <i>Adapters / Hosetails for electric valves</i> Фланцы / Штуцеры для электроклапанов
	Dispositivo scarico pressione <i>Exhaust device</i> Разгрузочное устройство давления

FEATURES

	Prodotti non per uso alimentare <i>Products not for food use</i> Не годится для пищевых продуктов
---	--

Gruppi di comando

I gruppi di comando GEOLINE sono realizzati con i migliori materiali plastici e le migliori gomme.

Le parti in metallo sono in acciaio inox AISI 303 o in ottone per garantire la massima affidabilità e durata.

Control units

All GEOLINE control units are made with the best quality plastic and rubber materials. The internal metal components are in stainless steel AISI 303 to ensure the utmost reliability and long life.

Блоки управления

Блоки управления GEOLINE изготовлены из лучших пластиковых материалов и резины. Металлические детали из нержавеющей стали AISI 303 в целях гарантии надежности и долговечности.



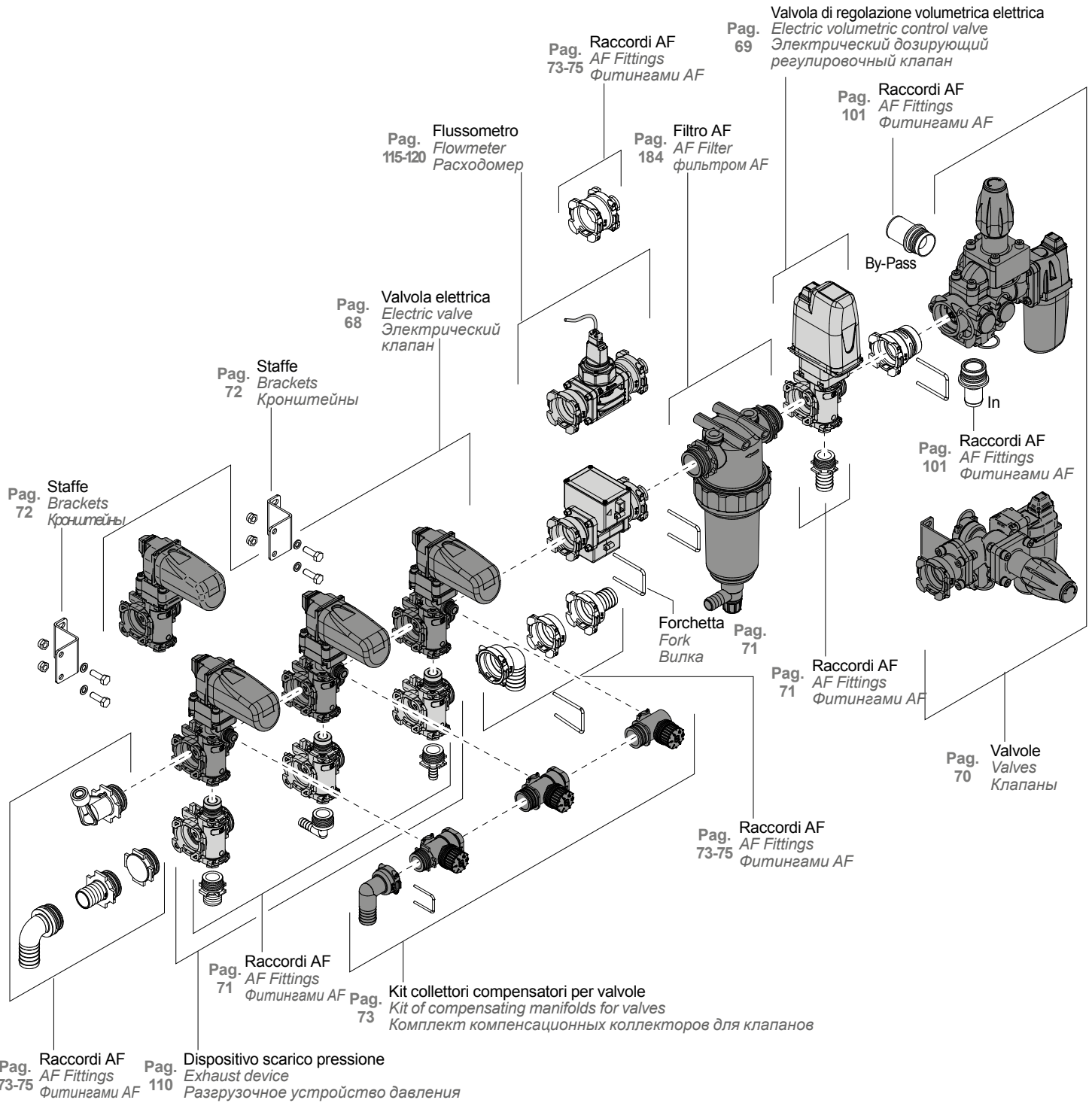

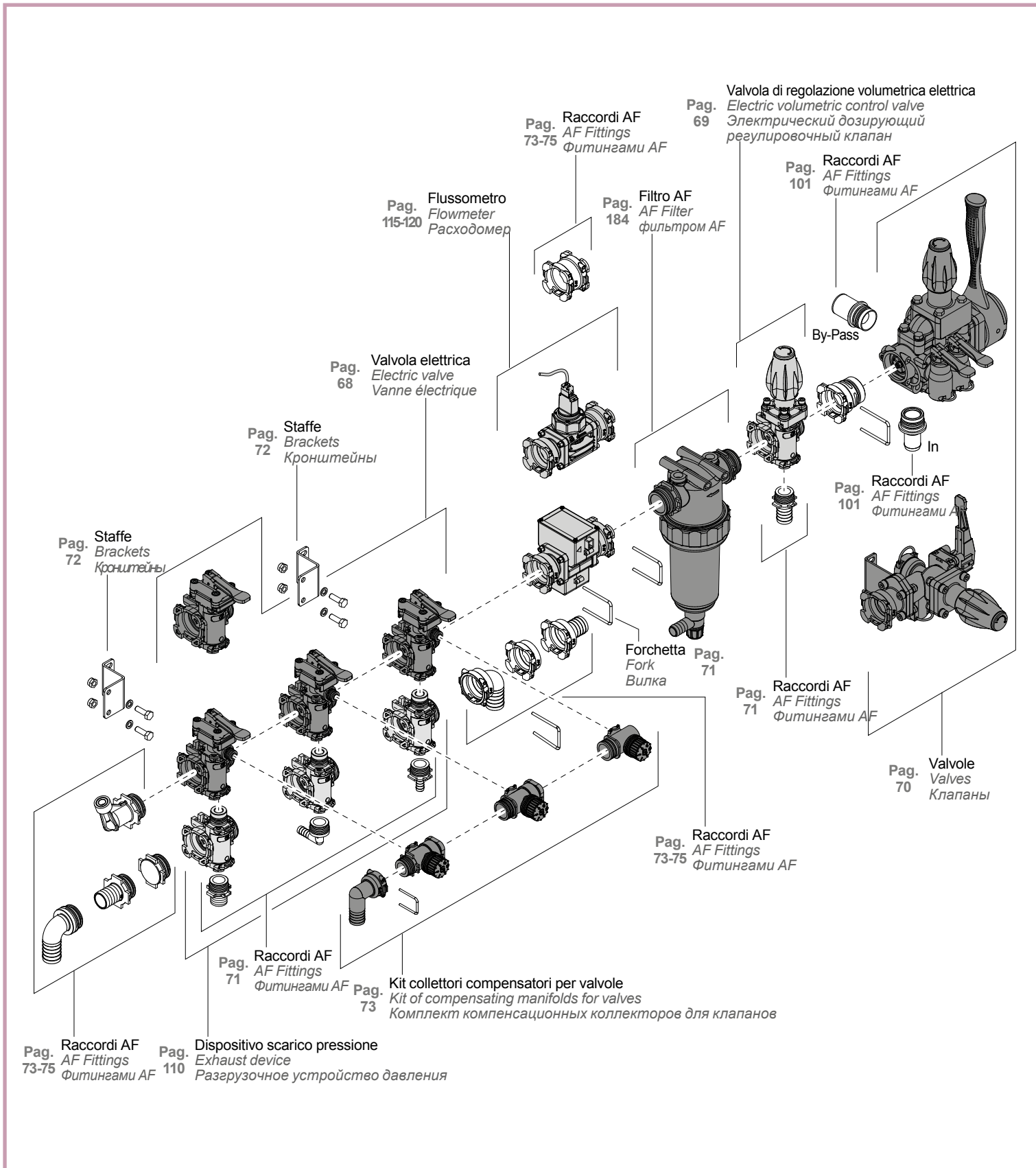

Valvola elettrica On/Off di sezione per barra.
Attacco a forchetta.

On/Off electric section valve for spraying boom
and orchard sprayers. Fork coupling.

Электрический секционный клапан On/Off
для штанги. Вилочное соединение.

NRG-AF



Part No.	I/1'	bar	sec	°C	V dc	Pack
8388022	15*+45*	20	0,20	60	12	2

3W NRG-AF



Part No.	I/1'	bar	sec	°C	V dc	Pack
8388023	15*+45*	20	0,20	60	12	2



Obbligatorio ordinare separatamente.
Compulsory: to be ordered separately.
Обязательно: заказывать отдельно.



Pag. 71



Pag. 73-75



Pag. 73



Pag. 72

OUT

OPTIONALS



Pag. 62



Pag. 40→45



Pag. 8→35

* Valore variabile in funzione del diametro del portagomma, con pressione di 0,5bar.

* Value varies depending on diameter of hose-tail, with 0,5bar pressure.

* Значение зависит от диаметра штуцера при давлении 0,5 бар.



Valvola manuale On/Off di sezione per barra.
Attacco a forchetta.

Manual On/Off section valve for spraying boom
and orchard sprayers. Fork coupling.

Ручной секционный клапан On/Off для
штанги. Вилочное соединение.

NRG-AF



Part No.	I/1'	bar	°C	Pack
8388024	15* + 45*	20	60	2

3W NRG-AF



Part No.	I/1'	bar	°C	Pack
8388025	15* + 45*	20	60	2

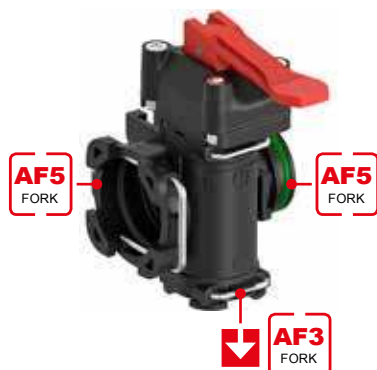

Obbligatorio ordinare separatamente.
Compulsory: to be ordered separately.
Обязательно: заказывать отдельно.



Pag. 71



Pag. 73-75



Pag. 73



Pag. 72

OUT

* Valore variabile in funzione del diametro del portagomma, con pressione di 0,5bar.

* Value varies depending on diameter of hose-tail, with 0,5bar pressure.

* Значение зависит от диаметра штуцера при давлении 0,5 бар.

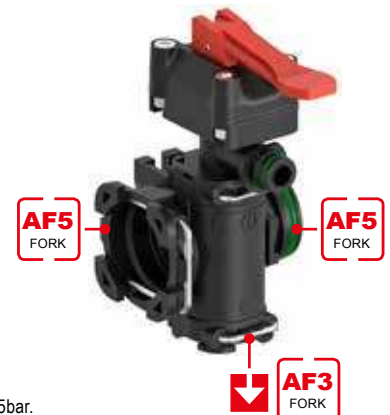

A 3 VIE / 3-WAY / 3-ХОД.

Valvola di regolazione volumetrica elettrica.
Attacco a forchetta.

Questa nuova valvola adotta soluzioni tecniche che consentono di utilizzare tutti raccordi di uscita "AF3", indipendentemente dalla portata.

Electric volumetric control valve.
Fork coupling.

This new valve features technical solutions that allow the use of "AF3" output fittings for all flow ranges.

Электрический дозирующий регулировочный клапан.
Вилочное соединение.

Этот новый клапан использует технические решения которые позволяют использовать все фитинги с выходом "AF3", независимо от потока.

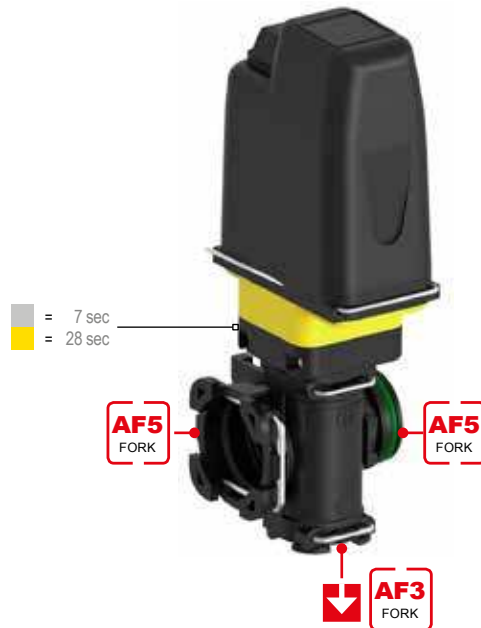

OPTIONALS



Pag. 62



Pag. 40→45



Pag. 8→35

NRG-AF

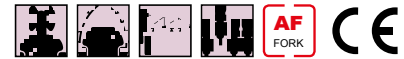

Part No.	I/1"	bar	sec	°C	V dc	Pack
8386032	100	20	7	60	12	1
8386033	150	20	7	60	12	1
8386026	100	20	28	60	12	1
8386027	150	20	28	60	12	1

Obbligatorio ordinare separatamente.
Compulsory: to be ordered separately.
Обязательно: заказывать отдельно.

AF
Pag. 71
OUT

AF
Pag. 73-75

AF
Pag. 73

AF
Pag. 72

Valvole di regolazione volumetriche manuali.
Attacco a forchetta.

Questa nuova valvola adotta soluzioni tecniche che consentono di utilizzare tutti raccordi di uscita "AF3", indipendentemente dalla portata della valvola stessa.

Manual volumetric control valves.
Fork coupling.

This new valve features technical solutions that allow the use of "AF3" output fittings for all flow ranges.

Ручные дозирующие регулировочные клапаны. Вилочное соединение.

Этот новый клапан использует технические решения которые позволяют использовать все фитинги с выходом «AF3», независимо от потока.



NRG-AF



Part No.	I/1"	bar	°C	Pack
8386028	100	20	60	1
8386029	150	20	60	1

Obbligatorio ordinare separatamente.
Compulsory: to be ordered separately.
Обязательно: заказывать отдельно.

AF
Pag. 71
OUT

AF
Pag. 73-75

AF
Pag. 73

AF
Pag. 72

Valvola elettrica di comando generale (ad azionamento elettrico) con valvola regolabile di massima pressione (manuale).
Attacco a forchetta.

Electric main control valve with manual adjustable pressure relief valve.
Fork coupling.

Главный электрический клапан управления (с электроприводом) с регулируемым клапаном максимального давления (ручной).
Вилочное соединение

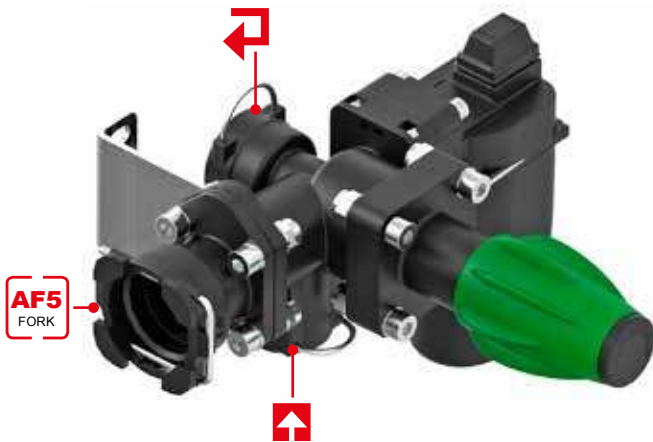

VGME 4-AF

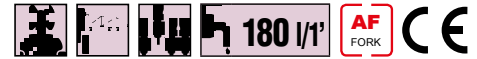

Part No.	l/1'	bar	sec	°C	V dc	Type	Pack
8370032	<60	20				"A"	1
8370033	180	10	0,2	60	12	"A"	1
8370034		20				"A"	1

"A" = a 2 fili / 2 wires / 2 пров

OPTIONALS



Pag. 62



Pag. 40→45



Pag. 8→35



Obbligatorio ordinare i raccordi separatamente.
Compulsory: fitting to be ordered separately.
Обязательно: заказывать фитинги отдельно.



Pag. 101



Pag. 101

Valvola di comando generale manuale con valvola regolabile di massima pressione manuale.

Manual main control valve with manual adjustable pressure relief valve.

Главный ручной клапан управления с регулируемым клапаном максимального давления.



VGM 4-AF



Part No.	l/1'	bar	°C	Pack
8370035	<60	20		1
8370036	180	10	60	1
8370037		20		1



Obbligatorio ordinare i raccordi separatamente.
Compulsory: fitting to be ordered separately.
Обязательно: заказывать фитинги отдельно.



Pag. 101



Pag. 101



OUT

Raccordi d'uscita per valvole sezione barra e valvole di regolazione volumetrica elettriche.
O-ring non incluso nei raccordi.
Da ordinare separatamente

Boom section valves and electric volumetric control valves hosesails.
O-ring not included with fittings.
To be ordered separately

Выходные фитинги для клапанов секции штанги и электрических клапанов регулировки расхода.
Круглая резиновая прокладка не включена.
Заказывается отдельно.

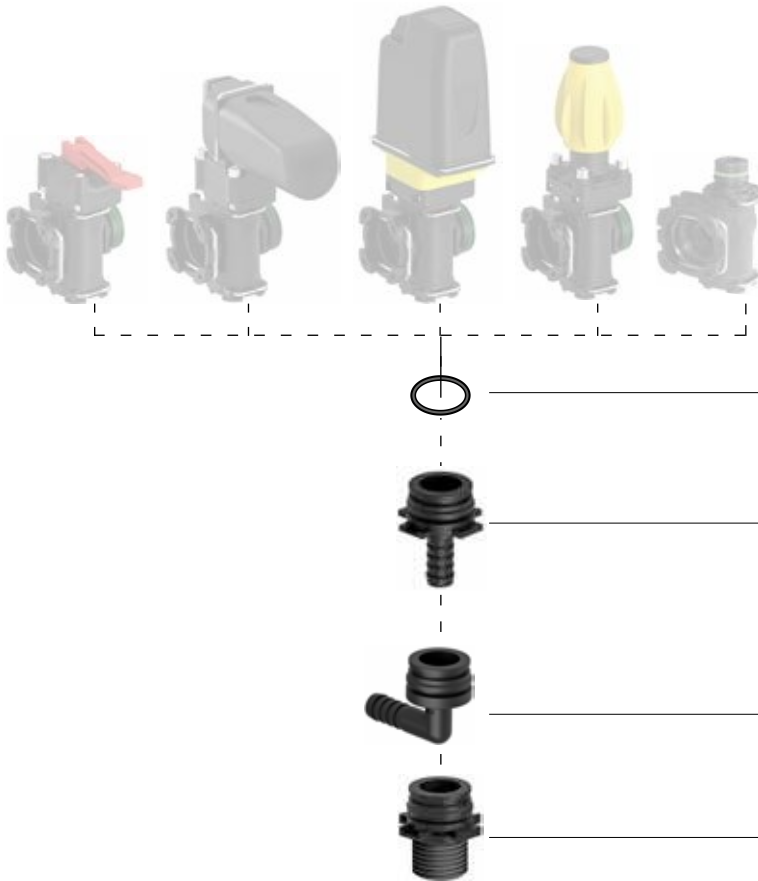

Part No.	Ø mm	Type	Pack
G00001021	/	OR Viton®	25
8416301	10	AF3	1
8416302	13		
8416303	16		
8416304	19		
8416305	25		
8416306	30		
8420301	10	AF3	90°
8420302	13		
8420303	16		
8420304	20		
8420305	25		
8426301	G 3/4 M	AF3	1



FORK

NRG series

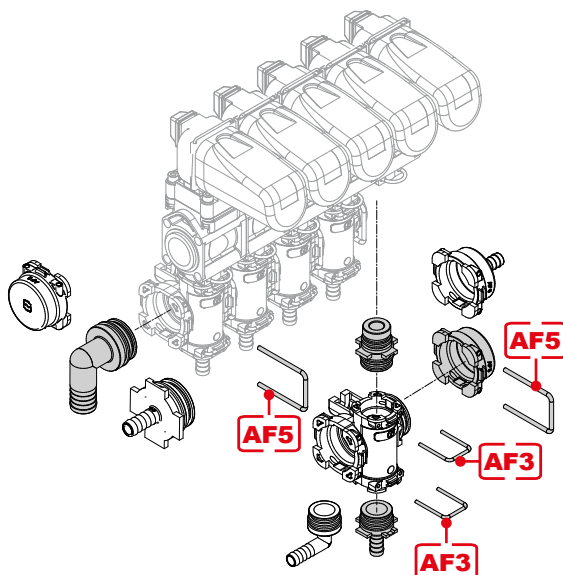

Part No.	Description	AF	Pack
F00000025	Metal fork	3	1
F00000029	Metal fork	5	1



MOUNTING KIT

Kit di fissaggio in acciaio inox per valvole attacco a forchetta.

Stainless steel mounting kit for fork coupling valves.

Комплект крепежных деталей из нержавеющей стали для клапанов с вилочным соединением.

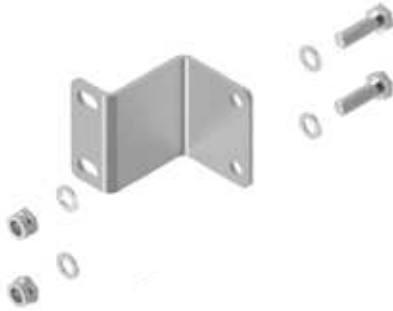

Part No.	Pack
8392087	1

MOUNTING

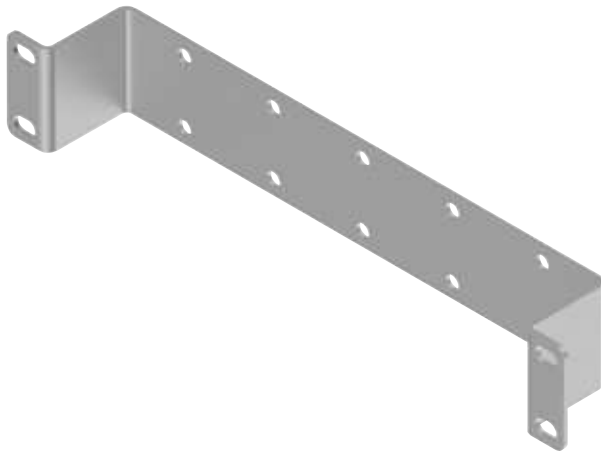
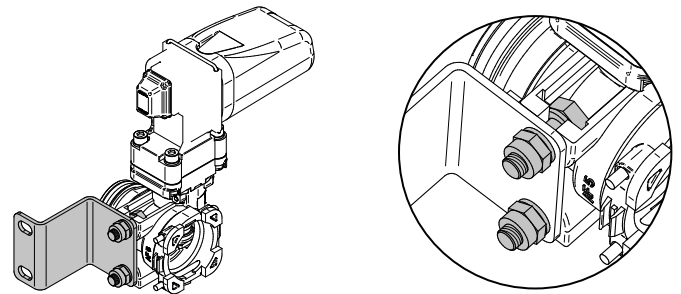

NEW

Part No.	L mm	Number of valves	Pack
S00400100	476	7	1
S00400107	418	6	1
S00400108	360	5	1

MOUNTING

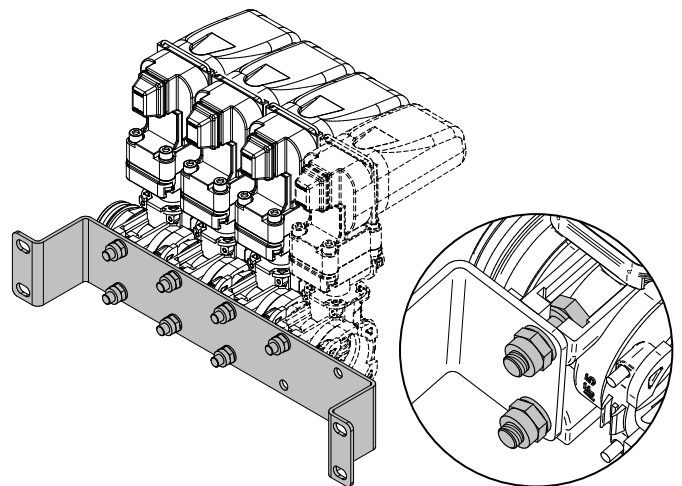

NEW

Kit di assemblaggio
Assembling kit
Сборочный комплект

Part No.	Pack
K00700036	1



MANIFOLDS KIT

Kit collettori compensatori per valvole con attacco a forchetta.

Kit of compensating manifolds for fork coupling valves.

Комплект компенсационных коллекторов для клапанов с вилочным соединением

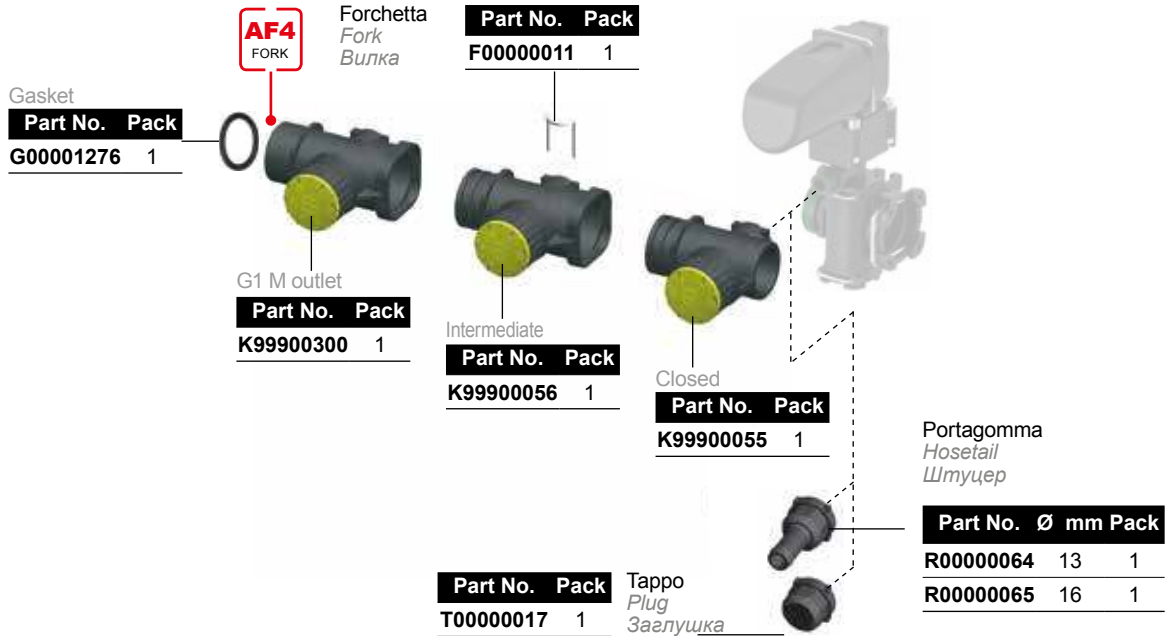

FITTINGS OUT / BY-PASS

Raccordi di completamento con attacco a forchetta.
O-ring e forchetta non inclusi nei raccordi.
Da ordinare separatamente

Completion fittings with fork coupling.
O-Ring and fork for fittings not included.
To be ordered separately.

Выходные фитинги для секционных клапанов штанги.
Круглая резиновая прокладка не включена.
Заказывается отдельно.

Portagomma dritto attacco a forchetta femmina
Straight hosetail with female fork coupling
Прямой штуцер с вилочным креплением "мама"

Portagomma dritto attacco a forchetta maschio
Straight hosetail with male fork coupling
Прямой штуцер с вилочным креплением "папа"



Part No.	AF	Ø mm	L mm	Pack	Fork
8415301		10	48	25	
8415302		13	48	25	
8415303	3	16	48	25	F00000025
8415304		20	54	25	
8415305		25	54	25	
8415501		13	52	25	
8415502		16	52	25	
8415503		20	58	25	
8415504		25	58	25	
8415505	5	30	58	25	F00000029
8415506		32	61	25	
8415507		35	63	25	
8415508		38	69	25	
8415509		40	69	25	

Part No.	AF	Ø mm	L mm	Pack	EPDM O-ring	VITON® O-ring
8416301		10	38	25		
8416302		13	38	25		
8416303	3	16	38	25	G00001020	G00001021
8416304		20	44	25		
8416305		25	44	25		
8416306		30	44	25		
8416501		13	40	25		
8416502		16	40	25		
8416503		20	45	25		
8416504		25	45	25		
8416505	5	30	45	25	G00001277	G00001074
8416506		32	49	25		
8416507		35	51	25		
8416508		38	57	25		
8416509		40	57	25		



FITTINGS OUT / BY-PASS

Raccordi di completamento con attacco a forchetta.
O-ring e forchetta non inclusi nei raccordi.
Da ordinare separatamente

Completion fittings with fork coupling.
O-Ring and fork for fittings not included.
To be ordered separately.

Выходные фитинги для секционных клапанов штанги.
Круглая резиновая прокладка не включена.
Заказывается отдельно.

Portagomma curvo 90° attacco a forchetta femmina
90° hosetail with female fork coupling
Штуцер 90° с вилочным креплением "мама"



Part No.	AF	Ø mm	L mm	Pack	Fork
8419501		13	38	25	
8419502		16	38	25	
8419503		20	38	25	
8419504		25	38	25	
8419505	5	30	38	25	F00000029
8419506		32	38	25	
8419507		35	38	25	
8419508		38	38	25	
8419509		40	38	25	

Portagomma curvo 90° attacco a forchetta maschio
90° hosetail with male fork coupling
Штуцер 90° с вилочным креплением "папа"



Part No.	AF	Ø mm	L mm	Pack	EPDM O-ring	VITON® O-ring
8420301		10	24	25		
8420302		13	24	25		
8420303	3	16	24	25	G00001020	G00001021
8420304		20	24	25		
8420305		25	24	25		
8420501		13	35	25		
8420502		16	35	25		
8420503		20	35	25		
8420504		25	35	25		
8420505	5	30	35	25	G00001277	G00001074
8420506		32	35	25		
8420507		35	35	25		
8420508		38	35	25		
8420509		40	35	25		

Tappo attacco a forchetta femmina
Female fork coupling plug
Заглушка с вилочным креплением "мама"



Part No.	AF	L mm	Pack	Fork
8459301	3	18	25	F00000025
8459501	5	21	25	F00000029

Tappo attacco a forchetta maschio
Male fork coupling plug
Заглушка с вилочным креплением "папа"

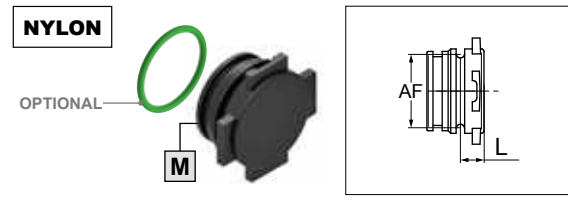

Part No.	AF	L mm	Pack	EPDM O-ring	VITON® O-ring
8460301	3	9	25	G00001020	G00001021
8460501	5	11	25	G00001277	G00001074



AF
FORK

FITTINGS OUT / BY-PASS

Raccordi di completamento con attacco a forchetta.
O-ring e forchetta non inclusi nei raccordi.
Da ordinare separatamente

Completion fittings with fork coupling.
O-Ring and fork for fittings not included.
To be ordered separately.

Выходные фитинги для секционных
клапанов штанги.
Круглая резиновая прокладка не включена.
Заказывается отдельно.

Manicotto attacco a forchetta femmina
Female fork coupling plug
Патрубок с вилочным креплением "мама"

Niplo attacco a forchetta maschio
Male fork coupling plug
Патрубок с вилочным креплением "папа"

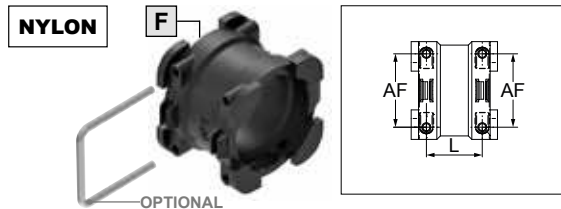

Part No.	AF	L mm	Pack	Fork
8433501	5	32	1	F0000029

Part No.	AF	L mm	Pack	EPDM	VITON®
				O-ring	O-ring
8434301	3	17	1	G00001020	G00001021
8434501	5	20	1	G00001277	G00001074

Kit adattatore femmina VGM5-VGME5
Female adapter kit VGM5-VGME5
Компл.адаптера "мама" VGM5-VGME

Kit adattatore maschio VGM5-VGME5
Male adapter kit VGM5-VGME5
Компл.адаптера "папа" VGM5-VGME



Part No.	AF	L mm	Pack	Fork
F00102037	5	22	1	F0000029

Part No.	AF	L mm	Pack	EPDM	VITON®
				O-ring	O-ring
F00102036	5	22	1	G00001277	G00001074

Flangia porta manometro
Pressure gauge adapter
Фланец держ.манометра

Flangia porta manometro
Pressure gauge adapter
Фланец держ.манометра



Part No.	AF	L mm	Pack	Fork
F00102039	5	37	1	F0000029

Part No.	AF	L mm	Pack	EPDM	VITON®
				O-ring	O-ring
F00102038	5	46	1	G00001277	G00001074

Kit adattatore VVGE-VGM-VGME-NRG
Adapter kit VGE-VGM-VGME-NRG
Компл.адаптера VGE-VGM-VGME-NRG

Kit adattatore VGE-VGM-VGME-NRG
Adapter kit VVGE-VGM-VGME-NRG
Компл.адаптера VGE-VGM-VGME-NRG



Part No.	AF	Type	L mm	Pack	Fork
F00102028	5	NRG M	47	1	F0000029

Part No.	AF	Type	L mm	Pack	EPDM	VITON®
					O-ring	O-ring
8392098	5	NRG F	35	1	G00001277	G00001074

Distributore elettrico con valvola volumetrica, filtro, valvola di massima pressione, comando generale e flussometro.

Electric control unit with volumetric regulating valve, filter, main control valve, manual adjustable pressure relief valve and flow-meter.

Электрический распределитель с дозирующим клапаном, фильтром, клапаном максимального давления, главным регулировочным клапаном и расходомером.

Predisposto per dialogare con i computer serie GeoSystem.

Suitable to be connected to GeoSystem computer series.

Предусмотрен для соединения с компьютерами серии GeoSystem.

GSMSTF/DRIVER - PLUS

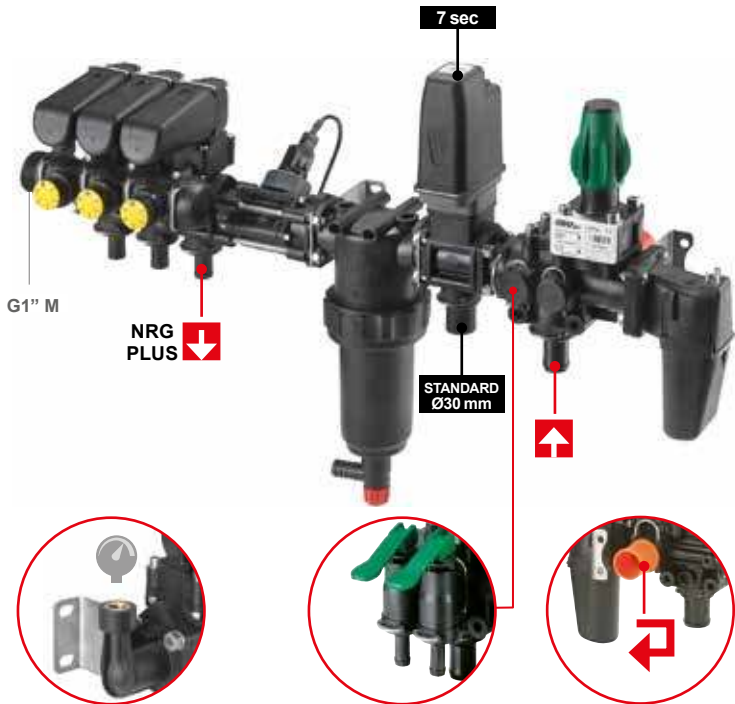

Part No.	Valves	l/1'	bar	°C	V dc	Pack
8376127	3	300	15	60	12	1
8376128	4					1
8376129	5					1
8376131	7					1

Obbligatorio ordinare i raccordi separatamente.
Compulsory: fitting to be ordered separately.
Обязательно: заказывать фитинги отдельно.

IN ↑ Pag. 101 **OUT** ↓ Pag. 103 **BY-PASS** ↻ Pag. 101

OPTIONALS

				P/N K00102000 Rubinetti modulari Modular valves Модульн.клапаны
Pag. 346	Pag. 62	Pag. 40→45	Pag. 8→35	

GSSTF/DRIVER - PLUS

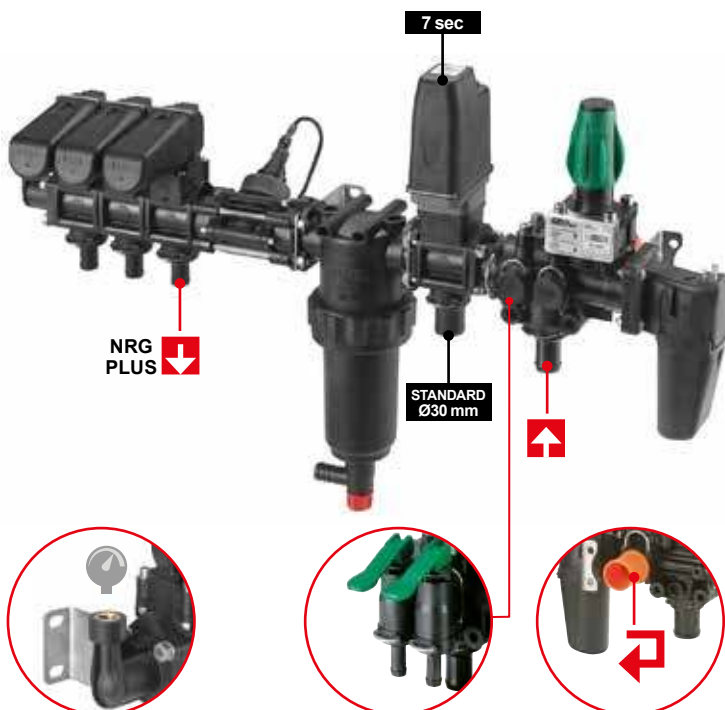

Part No.	Valves	l/1'	bar	°C	V dc	Pack
8376103	3	300	15	60	12	1
8376104	4					1
8376105	5					1
8376126	7					1

Obbligatorio ordinare i raccordi separatamente.
Compulsory: fitting to be ordered separately.
Обязательно: заказывать фитинги отдельно.

IN ↑ Pag. 101 **OUT** ↓ Pag. 103 **BY-PASS** ↻ Pag. 101

OPTIONALS

				P/N K00102000 Rubinetti modulari Modular valves Модульн.клапаны
Pag. 346	Pag. 62	Pag. 40→45	Pag. 8→35	

Distributore elettrico con valvola volumetrica, filtro, valvola di massima pressione, comando generale e flussometro.

Electric control unit with volumetric regulating valve, filter, main control valve, manual adjustable pressure relief valve and flow-meter.

Электрический распределитель с дозирующим клапаном, фильтром, клапаном максимального давления, главным регулировочным клапаном и расходомером.

Predisposto per dialogare con i computer serie GeoSystem.

Suitable to be connected to GeoSystem computer series.

Предусмотрен для соединения с компьютерами серии GeoSystem.

GSMSTF/DRIVER - 06

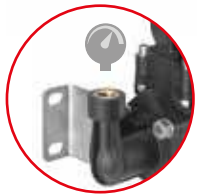
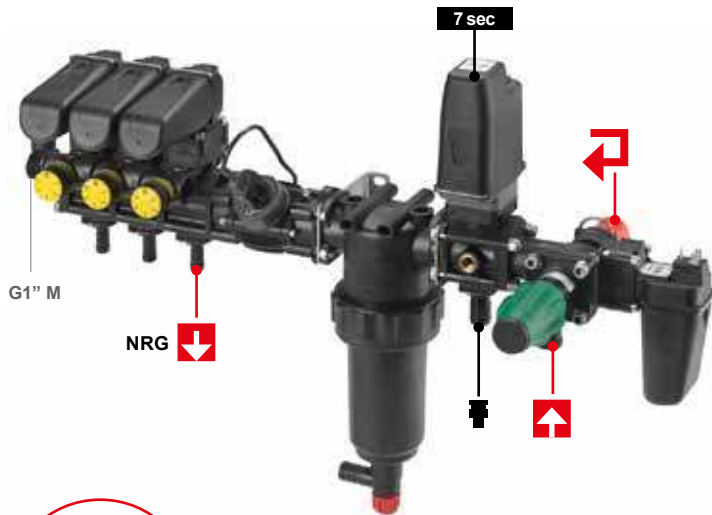

Part No.	Valves	I/1'	bar	Ø mm	°C	V dc	Pack
8376132	3			19			1
8376133	4			25			1
8376134	5	180	15	25	60	12	1
8376144	6			25			1
8376135	7			25			1

Obbligatorio ordinare i raccordi separatamente.
Compulsory: fitting to be ordered separately.
Обязательно: заказывать фитинги отдельно.

IN
↑ Pag. 101

OUT
↓ Pag. 103

BY-PASS
↻ Pag. 101

OPTIONALS



Pag. 346



Pag. 62



Pag. 40→45



Pag. 8→35



Pag. 110

GSMF/DRIVER - 06

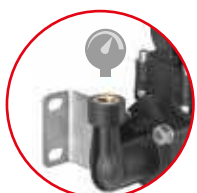
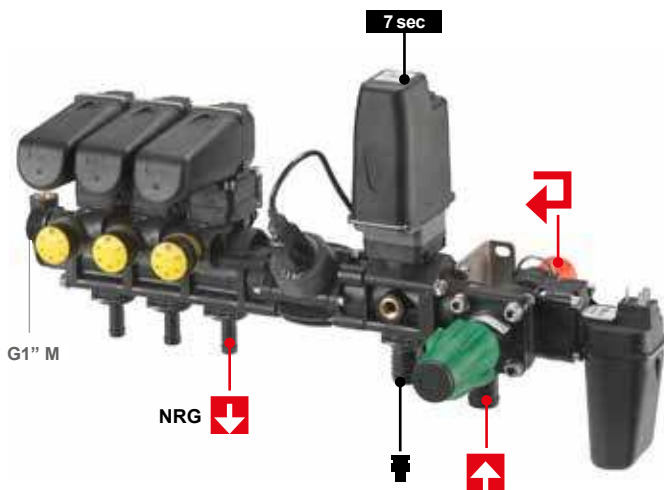
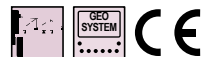

Part No.	Valves	I/1'	bar	Ø mm	°C	V dc	Pack
8376138	3			25			1
8376136	4			25			1
8376137	5	180	20	25	60	12	1
8376139	7			25			1
8376148	9			25			1

Obbligatorio ordinare i raccordi separatamente.
Compulsory: fitting to be ordered separately.
Обязательно: заказывать фитинги отдельно.

IN
↑ Pag. 101

OUT
↓ Pag. 103

BY-PASS
↻ Pag. 101

OPTIONALS



Pag. 346



Pag. 62



Pag. 40→45



Pag. 8→35



Pag. 110

GSSTF/DRIVER - 06

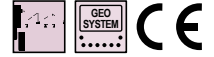

Distributore elettrico con valvola volumetrica, filtro, valvola di massima pressione, comando generale e flussometro.

Electric control unit with volumetric regulating valve, filter, main control valve, manual adjustable pressure relief valve and flow-meter.

Электрический распределитель с дозирующим клапаном, фильтром, клапаном максимального давления, главным регулировочным клапаном и расходомером.

Predisposto per dialogare con i computer serie GeoSystem.

Suitable to be connected to GeoSystem computer series.

Предусмотрен для соединения с компьютерами серии GeoSystem.

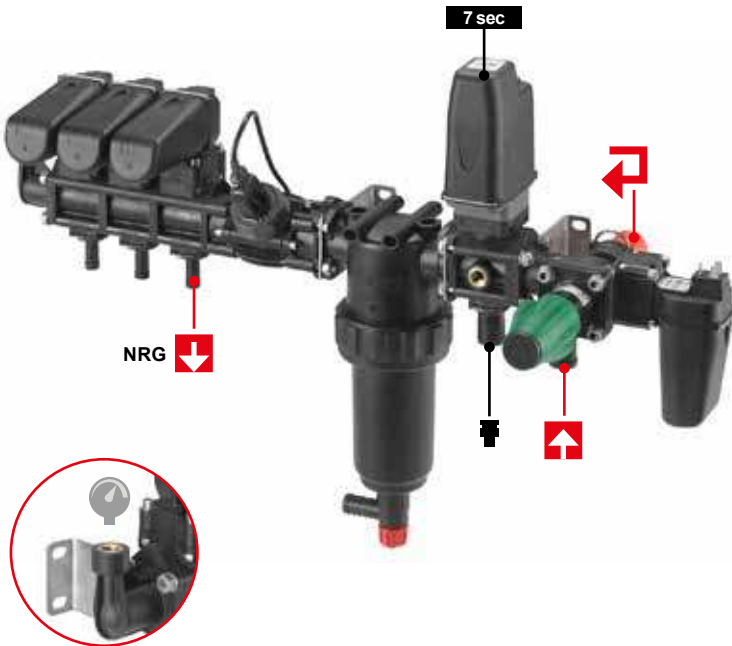

Part No.	Valves	I/I'	bar	Ø mm	°C	V dc	Pack
8376099	3			19			1
8376100	4	180	15	25	60	12	1
8376101	5			25			1
8376102	7			25			1

Obbligatorio ordinare i raccordi separatamente.
Compulsory: fitting to be ordered separately.
Обязательно: заказывать фитинги отдельно.

IN
↑ Pag. 101

OUT
↓ Pag. 103

BY-PASS
↻ Pag. 101

OPTIONALS

Pag. 346	Pag. 62	Pag. 40→45	Pag. 8→35	Pag. 110

GSF PILOT

HIGH PRESSURE



Distributore elettrico con valvola volumetrica manuale, valvola regolabile di massima pressione, valvola di scarico, valvole di sezione compensate e flange in ottone.

Predisposto per dialogare con i computer serie GeoSystem.

Electric control unit for orchard sprayers with manual volumetric valve, pressure relief valve, dump valve, metered section valves, and flowmeter and brass flanges.

Suitable to be connected to GeoSystem computer series.

Электрический распределитель с ручным дозирующим клапаном, регулируемым клапаном максимального давления, спускным клапаном, компенсированными секционными клапанами и латунными фланцами.

Предусмотрен для соединения с компьютерами серии GeoSystem.



Part No.	Valves	Type	I/I'	bar	°C	V dc	Pack
8378034	2	TURBINE FLOW	150	20	60	12	1
8378035	2			40			1
8378056	3			40			1
8378036	4			20			1
8378037	4			40			1
8378038	5			40			1

OPTIONALS



Pag. 346



Pag. 62



Pag. 40-45

Only **RD



Pag. 8-35



Pag. 110



Part No.	Valves	Type	I/I'	bar	°C	V dc	Pack
8378039	2	ELEMAG FLOW	150	20	60	12	1
8378040	2			40			1
8378041	4			20			1
8378042	4			40			1
8378043	5			40			1

OPTIONALS



Pag. 346



Pag. 62



Pag. 40-45

Only **RD



Pag. 8-35



Pag. 110

STF/DRIVER - PLUS



Distributore elettrico STF/DRIVER-PLUS con valvola volumetrica, filtro, valvola di massima pressione, comando generale e flussometro.

Electric control unit STF/DRIVER-PLUS with volumetric regulating valve, filter, main control valve, manual adjustable pressure relief valve and flow-meter.

Электрический распределитель STF/DRIVER-PLUS с дозирующим клапаном, фильтром, клапаном максимального давления, главным регулировочным клапаном и расходомером.

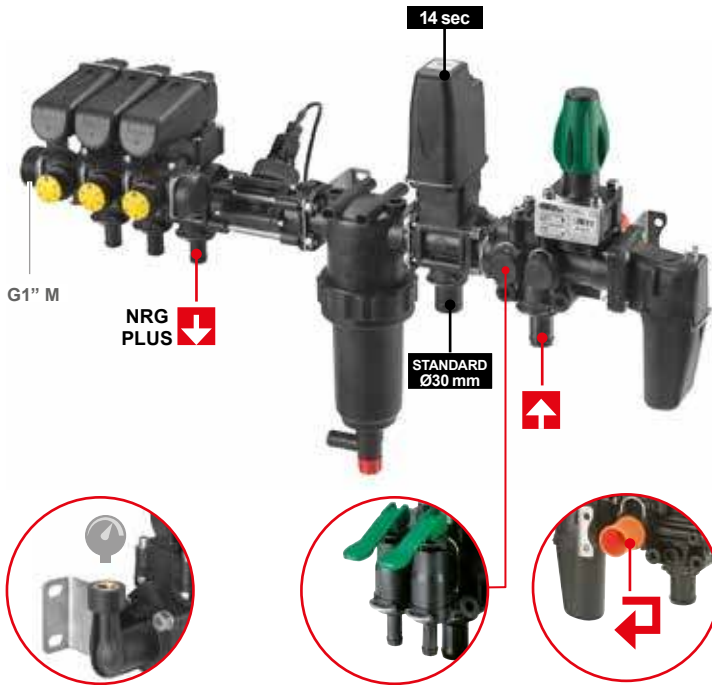

Part No.	Valves	l/1'	bar	°C	V dc	Pack
8376090	3					1
8376091	4	300	15	60	12	1
8376092	5					1
8376130	7					1

Obbligatorio ordinare i raccordi separatamente.
Compulsory: fitting to be ordered separately.
Обязательно: заказывать фитинги отдельно.

IN ↑ Pag. 101 **OUT** ↓ Pag. 103 **BY-PASS** ↻ Pag. 101

OPTIONALS

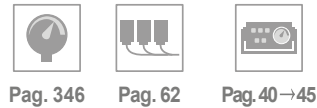

STF/DRIVER - 06



Distributore elettrico STF/DRIVER-06 con valvola volumetrica, filtro, valvola di massima pressione, comando generale e flussometro.

Electric control unit STF/DRIVER-06 with volumetric regulating valve, filter, main control valve, manual adjustable pressure relief valve and flow-meter.

Электрический распределитель STF/DRIVER-06 с дозирующим клапаном, фильтром, клапаном максимального давления, главным регулировочным клапаном и расходомером.

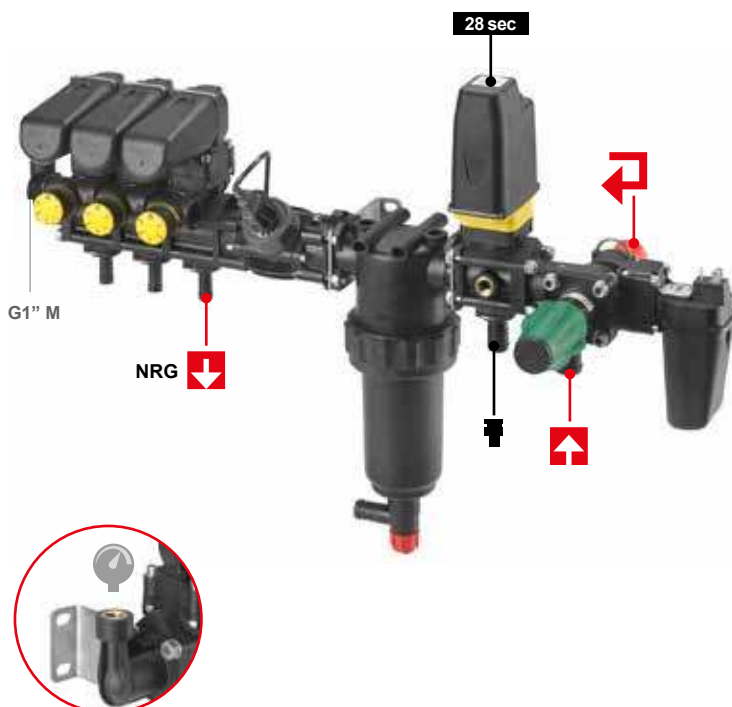

Part No.	Valves	l/1'	bar	Ø mm	°C	V dc	Pack
8376083	3			19			1
8376084	4	180	15	25	60	12	1
8376085	5			25			1
8376123	7			25			1

Obbligatorio ordinare i raccordi separatamente.
Compulsory: fitting to be ordered separately.
Обязательно: заказывать фитинги отдельно.

IN ↑ Pag. 101 **OUT** ↓ Pag. 103 **BY-PASS** ↻ Pag. 101

OPTIONALS



ST/DRIVER - PLUS



Distributore elettrico ST/DRIVER-PLUS con valvola volumetrica, filtro, valvola di massima pressione e comando generale.

Electric control unit ST/DRIVER-PLUS with volumetric regulating valve, filter, main control valve with manual adjustable pressure relief valve.

Электрический распределитель ST/DRIVER-PLUS с дозирующим клапаном, фильтром, клапаном максимального давления и главным регулировочным клапаном.

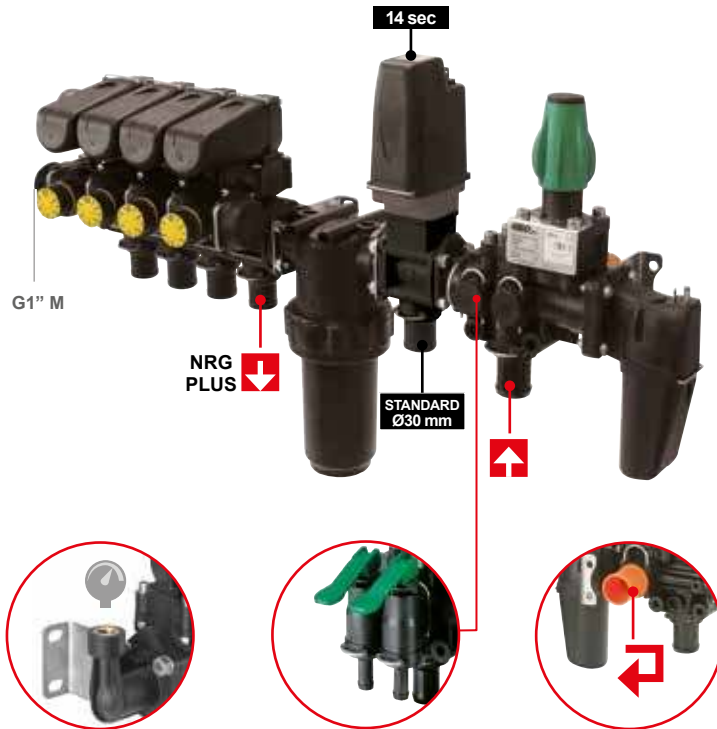

Part No.	Valves	l/1'	bar	°C	V dc	Pack
8376093	3					1
8376094	4	300	15	60	12	1
8376095	5					1

Obbligatorio ordinare i raccordi separatamente.
Compulsory: fitting to be ordered separately.
Обязательно: заказывать фитинги отдельно.

IN ↑ Pag. 101 **OUT** ↓ Pag. 103 **BY-PASS** ↻ Pag. 101

OPTIONALS

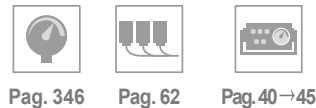

ST/DRIVER



Distributore elettrico ST/DRIVER con valvola volumetrica, filtro, valvola di massima pressione e comando generale.

Electric control unit ST/DRIVER with volumetric regulating valve, filter, main control valve with manual adjustable pressure relief valve.

Электрический распределитель ST/DRIVER с дозирующим клапаном, фильтром, клапаном максимального давления и главным регулировочным клапаном.



Part No.	Valves	l/1'	bar	Ø mm	°C	V dc	Pack
8376063	3			19			1
8376020	4	210	15	25	60	12	1
8376021	5			25			1
8376022	6			25			

Obbligatorio ordinare i raccordi separatamente.
Compulsory: fitting to be ordered separately.
Обязательно: заказывать фитинги отдельно.

IN ↑ Pag. 101 **OUT** ↓ Pag. 103 **BY-PASS** ↻ Pag. 101

OPTIONALS



Complete control unit: Pag. 139

ST/DRIVER - 06



Distributore elettrico serie ST/DRIVER-06 con valvola volumetrica, filtro, valvola di massima pressione e comando generale.

Electric control unit ST/DRIVER-06 with volumetric regulating valve, filter, main control valve with manual adjustable pressure relief valve.

Электрический распределитель ST/DRIVER-06 с дозирующим клапаном, фильтром, клапаном максимального давления и главным регулировочным клапаном.



Complete control unit: Pag. 139

Part No.	Valves	I/1'	bar	Ø mm	°C	V dc	Pack
8376087	2			19			1
8376088	3			19			1
8376076	4	180	15	25	60	12	1
8376077	5			25			1
8376078	6			25			1
8376125	7			25			1

Obbligatorio ordinare i raccordi separatamente.
Compulsory: fitting to be ordered separately.
Обязательно: заказывать фитинги отдельно.



Pag. 101



Pag. 103



Pag. 101

OPTIONALS



Pag. 346



Pag. 62



Pag. 40→45

DRIVER - PLUS



Distributore elettrico DRIVER PLUS con valvola volumetrica, valvola regolabile di massima pressione e comando generale.

Electric control unit DRIVER PLUS with volumetric regulating valve, manual adjustable pressure relief valve and main control valve.

Электрический распределитель DRIVER PLUS с дозирующим клапаном, клапаном максимального давления и главным регулировочным клапаном.



Part No.	Valves	I/1'	bar	°C	V dc	Pack
8376096	3					1
8376097	4	300	20	60	12	1
8376098	5					1

Obbligatorio ordinare i raccordi separatamente.
Compulsory: fitting to be ordered separately.
Обязательно: заказывать фитинги отдельно.



Pag. 101



Pag. 103



Pag. 101

OPTIONALS



Pag. 346



Pag. 62



Pag. 40→45



DRIVER



Distributore elettrico DRIVER con valvola volumetrica, valvola regolabile di massima pressione e comando generale.

Electric control unit DRIVER with volumetric regulating valve, manual adjustable pressure relief valve and main control valve.

Электрический распределитель DRIVER с дозирующим клапаном, клапаном максимальной давления и главным регулировочным клапаном.

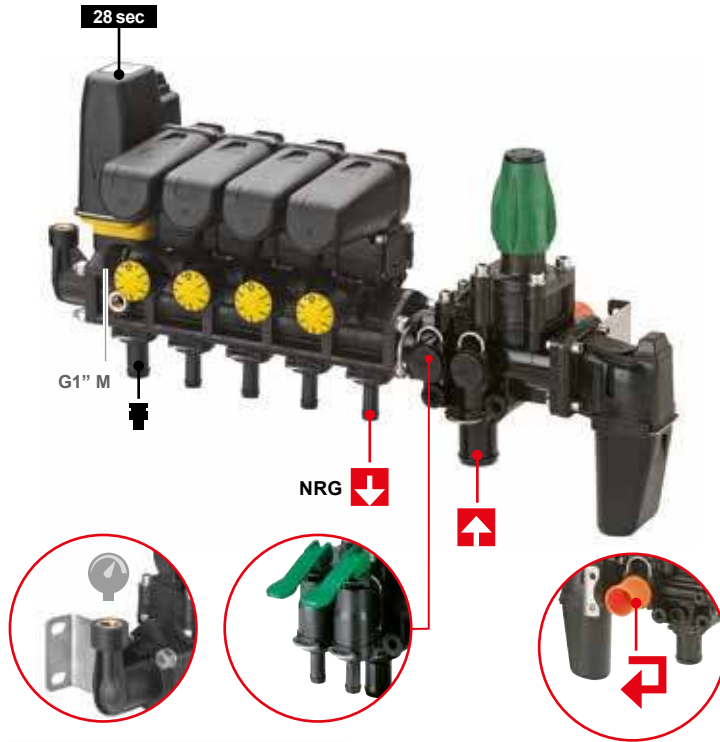

Complete control unit: Pag. 139

Part No.	Valves	l/1'	bar	Ø mm	°C	V dc	Pack
8376038	3	210	20	19	60	12	1
8376017	4			25			1
8376018	5			25			1
8376019	6			25			1

Obbligatorio ordinare i raccordi separatamente.
Compulsory: fitting to be ordered separately.
Обязательно: заказывать фитинги отдельно.

IN Pag. 101 **OUT** Pag. 103 **BY-PASS** Pag. 101

OPTIONALS

Pag. 346	Pag. 62	Pag. 40→45	Pag. 110	P/N K00102000 Rubinetti modulari Modular valves Модульн.клапаны
----------	---------	------------	----------	---

DRIVER - 06



Distributore elettrico serie DRIVER-06 con valvola volumetrica, valvola regolabile di massima pressione e comando generale.

Electric control unit DRIVER-06 with volumetric regulating valve, manual adjustable pressure relief valve and main control valve.

Электрический распределитель DRIVER-06 с дозирующим клапаном, регулируемым клапаном максимальной давления и главным регулировочным клапаном.

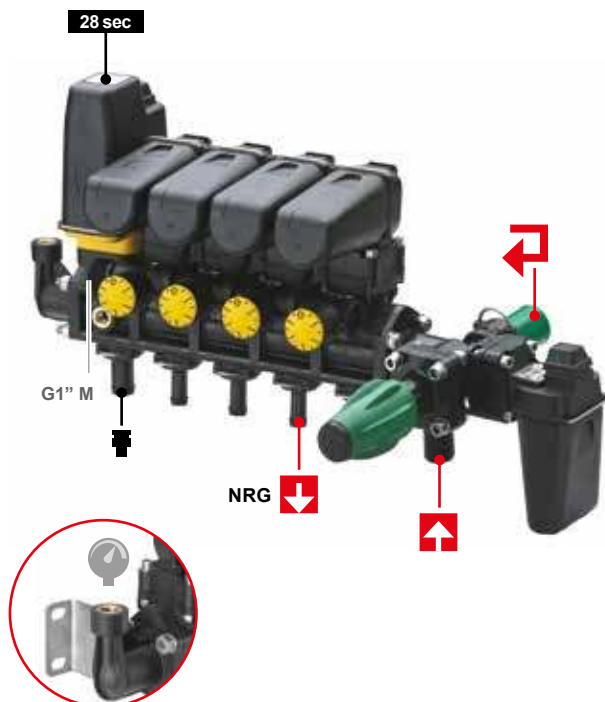

Complete control unit: Pag. 139

Part No.	Valves	l/1'	bar	Ø mm	°C	V dc	Pack
8376086	2	180	20	19	60	12	1
8376079	3			19			1
8376080	4			25			1
8376081	5			25			1
8376082	6			25			1

Obbligatorio ordinare i raccordi separatamente.
Compulsory: fitting to be ordered separately.
Обязательно: заказывать фитинги отдельно.

IN Pag. 101 **OUT** Pag. 103 **BY-PASS** Pag. 101

OPTIONALS

Pag. 346	Pag. 62	Pag. 40→45	Pag. 110
----------	---------	------------	----------

MIDI DRIVER 06



Distributore Midi Driver 06 a valvole compensate manuali modulari, con valvola di comando VGME4 ad azionamento elettrico e valvola regolabile di massima pressione.
I singoli rubinetti sono modulari.

Midi Driver 06 control unit with metered modular manual valves, electric VGME4 main valve and adjustable pressure relief valve.

Распределитель Midi Driver 06 с компенсационными ручными модульными клапанами, клапаном управления VGME4 с электроприводом и регулируемым клапаном максимального давления. Отдельные модульные краны.

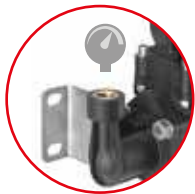
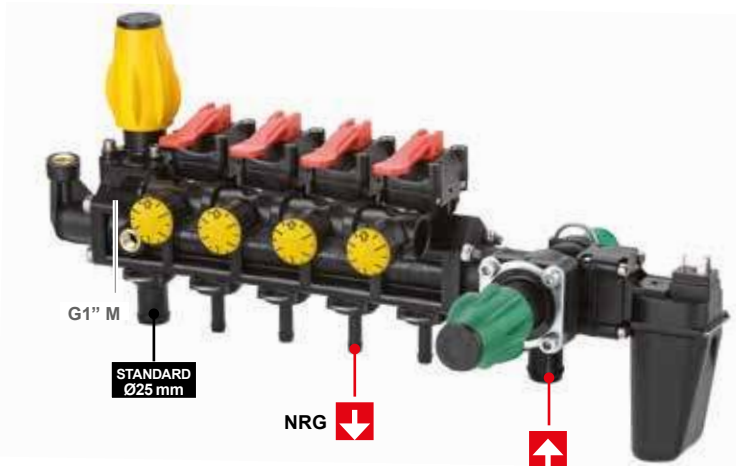

Part No.	Valves	l/1'	bar	°C	V dc	Pack
8376089	2					1
8376064	3					1
8376065	4	180	20	60	12	1
8376066	5					1
8376067	6					1

Obbligatorio ordinare i raccordi separatamente.
Compulsory: fitting to be ordered separately.
Обязательно: заказывать фитинги отдельно.

IN
Pag. 101

OUT
Pag. 103

BY-PASS
Pag. 101

OPTIONALS



Pag. 346



Pag. 62



Pag.40→45

BABY DRIVER 06



Distributore Baby Driver 06 a valvole manuali modulari ON/OFF, con valvola di comando VGME4 ad azionamento elettrico e valvola regolabile di massima pressione.
I singoli rubinetti sono modulari.

Baby Driver 06 control unit with ON/OFF modular manual valves, electric VGME4 main valve and adjustable pressure relief valve.

Распределитель Baby Driver 06 с ручными модульными клапанами ON-OFF, клапаном управления VGME4 с электроприводом и регулируемым клапаном максимального давления. Отдельные модульные краны.

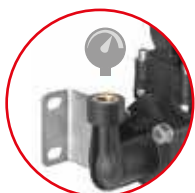
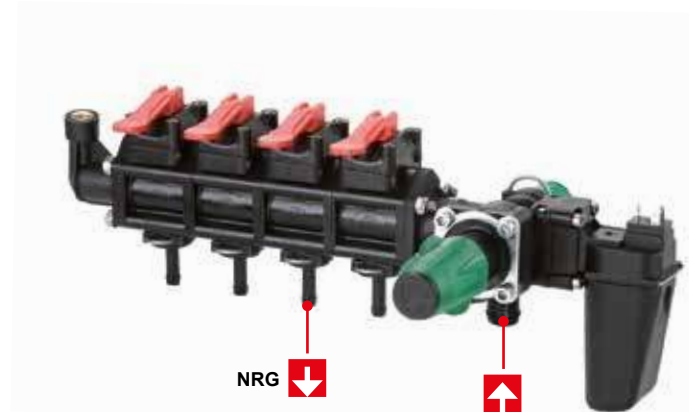

Part No.	Valves	l/1'	bar	°C	V dc	Pack
8374043	2					1
8374029	3					1
8374030	4	180	20	60	12	1
8374031	5					1
8374032	6					1

Obbligatorio ordinare i raccordi separatamente.
Compulsory: fitting to be ordered separately.
Обязательно: заказывать фитинги отдельно.

IN
Pag. 101

OUT
Pag. 103

BY-PASS
Pag. 101

OPTIONALS



Pag. 346



Pag. 62



Pag.40→45

PILOT 1

HIGH PRESSURE



Distributore elettrico con valvola volumetrica manuale, valvola regolabile di massima pressione, valvola di scarico, valvole di sezione compensate e flange in ottone.

Electric control unit for orchard sprayers with manual volumetric valve, pressure relief valve, dump valve, metered section valves and brass flanges.

Электрический распределитель с ручным дозирующим клапаном, регулируемым клапаном максимального давления, спускным клапаном, компенсационными секционными клапанами и латунными фланцами.



Part No.	Valves	I/1'	bar	°C	V dc	A	Pack
8378003	2		20			336	1
8378004	2	150	40	60	12	336	1
8378005	4		20			450	1
8378006	4		40			450	1

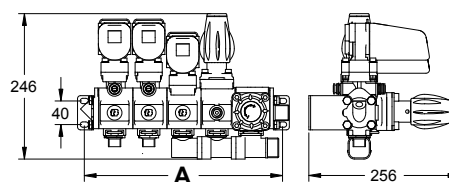

OPTIONALS



Pag. 346



Pag. 62



Pag. 40-45

Only
**RD

PILOT 2

HIGH PRESSURE



Distributore elettrico con valvola volumetrica elettrica, valvola regolabile di massima pressione, valvola di scarico, valvole di sezione compensate e flange in ottone.

Electric control unit for orchard sprayers with electric volumetric valve, pressure relief valve, dump valve, metered section valves and brass flanges.

Электрический распределитель с электрическим дозирующим клапаном, регулируемым клапаном максимального давления, спускным клапаном, компенсационными секционными клапанами и латунными фланцами.



Part No.	Valves	I/1'	bar	°C	V dc	A	Pack
8378007	2		20			336	1
8378008	2		40			336	1
8378009	4	150	20	60	12	450	1
8378010	4		40			450	1
8378026	5		40			450	1

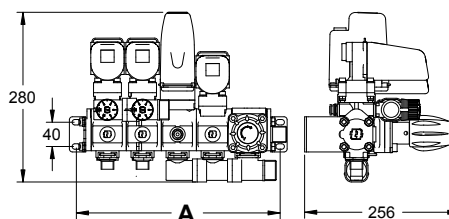

OPTIONALS



Pag. 346



Pag. 62



Pag. 40-45

Only
**RD

PILOT

HIGH PRESSURE



Distributore elettrico con valvola regolabile di massima pressione, valvola di scarico, valvole di sezione compensate, filtro e flange in ottone.

Electric control unit for orchard sprayers with pressure relief valve, dump valve, metered section valves, filter and brass flanges.

Электрический распределитель с регулируемым клапаном максимального давления, спускным клапаном, компенсационными секционными клапанами и латунными фланцами.



Part No.	Valves	l/1'	bar	°C	V dc	Pack
8378044	2	150	40	60	12	1

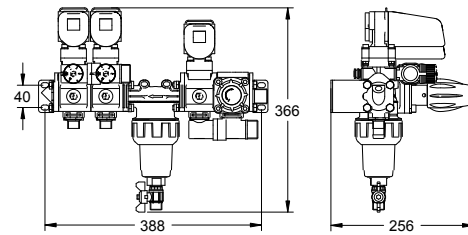

OPTIONALS



Pag. 346



Pag. 62



Pag.40→45

Only
**RD

PILOT

HIGH PRESSURE



Distributore elettrico con valvola volumetrica elettrica, valvola regolabile di massima pressione, valvola di scarico, valvole di sezione compensate, filtro e flange in ottone.

Electric control unit for orchard sprayers with electric volumetric valve, pressure relief valve, dump valve, metered section valves, filter and brass flanges.

Электрический распределитель с электрическим дозирующим клапаном, регулируемым клапаном максимального давления, спускным клапаном, компенсационными секционными клапанами и латунными фланцами.



Part No.	Valves	l/1'	bar	°C	V dc	Pack
8378045	2	150	40	60	12	1

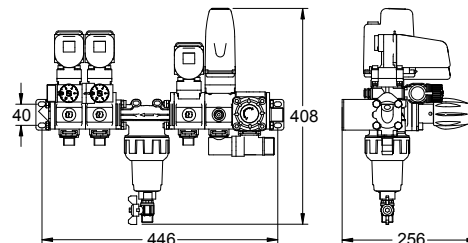

OPTIONALS



Pag. 346



Pag. 62



Pag.40→45

Only
**RD

KIT PILOT

HIGH PRESSURE



Gruppo di comando elettrico proporzionale a 2 vie.
Completo di: scatola di comando e cablaggi.

Composizione del kit:

- Gruppo di comando;
- Scatola di comando;
- Cavo collegamento.

2-way Electric control unit with control panel and connecting cables.

Kit composed of:

- Control unit;
- Control box;
- Connecting cable

Пропорциональный электрический блок управления на 2 линии.

Снабжен распределительной коробкой и кабелями.

Комплектация:

- Блок управления;
- Распределительная коробка;
- Соединительный кабель.



Part No.	Valves	I/1'	bar	°C	V dc	Pack
8378C0054	2	150	40	60	12	1



Part No.	Valves	I/1'	bar	°C	V dc	Pack
8378C0056	2	150	40	60	12	1

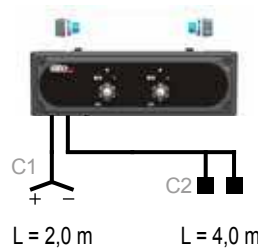

KIT MY18



Gruppo per atomizzatore 2 vie a pressione costante, composto da 2 elettrovalvole a solenoide e valvola manuale di regolazione pressione.

Uscita: G1/2" - Ingresso: 3/4"

Ideale per applicazioni su atomizzatori e gruppi irroranti.

2-way Control unit for orchard sprayers at constant pressure with 2 solenoid valves and pressure relief manual valve.

1/2" BSP outlet and 3/4" BSP inlet

Perfect for applications on orchard sprayers and spraying machines.

2-ходовой блок управления для распылителей при постоянном давлении, укомплектованный 2 электромагнитными клапанами и ручным регулировочным клапаном давления.

Выход : 1/2" BSP – Вход: 3/4" BSP

Предусмотрен для применения на распылителях и разбрызгивателях.

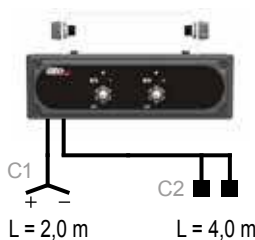

Part No.	Valves	I/1'	bar	°C	V dc	Pack
8378C0053	2	150	40	60	12	1

BASIC 217

HIGH PRESSURE



Distributore manuale con rubinetti modulari compensati e valvola di massima pressione.

Modular valve manual control unit with metered by-pass manifold and maximum pressure valve.

Распределитель с ручным управлением, с компенсированными модульными кранами и клапаном высокого давления



Part No.	Valves	I/1'	bar	°C	Pack
8378049	2				1
8378050	4	120	40	60	1
8378055	5				1

OPTIONALS



Pag. 346

ORION

NEW



Comando ORION per atomizzatori.

- pressione di esercizio max 60 bar
- portata max 180 l/min
- sfere selettive in acciaio inox

ORION control unit for orchard sprayers.

- max working pressure 60 bar
- max flow rate 180 l/min
- stainless steel selecting balls

Блок управления ORION для распылителей.

- максимальное рабочее давление 60 бар
- максимальный расход 180 л/мин
- селективные сферы из нержавеющей стали



Corpo in ottone
Brass body
Корпус из латуни

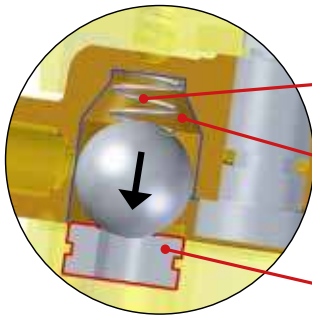

Nuova molla
New Spring
Новая пружина

Nuova sede per molla
New spring seat
Новое гнездо для пружины

Nuova sede in acciaio AISI 303
New AISI 303 stainless-steel seat
Новое гнездо из стали AISI 303

Part No.	l/1'	bar	°C	Pack
8378058		40		1
8378059	180	50	60	1
8378060		60		1

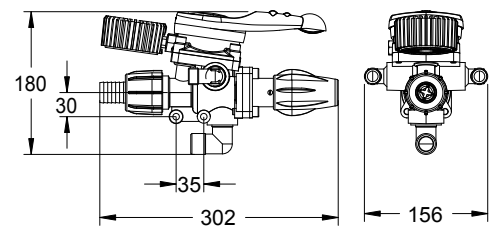

ALFA

NEW



Comando ALFA per atomizzatori.

- pressione di esercizio max 60 bar
- portata max 180 l/min
- sfere selettive in acciaio inox

ALFA control unit for orchard sprayers.

- max working pressure 60 bar
- max flow rate 180 l/min
- stainless steel selecting balls

Блок управления ALFA для распылителей.

- максимальное рабочее давление 60 бар
- максимальный расход 180 л/мин
- селективные сферы из нержавеющей стали



Corpo in ottone e alluminio
Brass and anodic aluminium body
Корпус из латуни и алюминия

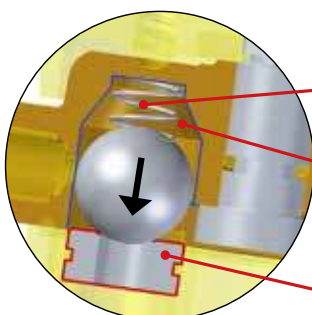

Nuova molla
New Spring
Новая пружина

Nuova sede per molla
New spring seat
Новое гнездо для пружины

Nuova sede in acciaio AISI 303
New AISI 303 stainless-steel seat
Новое гнездо из стали AISI 303

Part No.	l/1'	bar	°C	Pack
8378061		40		1
8378062	180	50	60	1
8378063		60		1

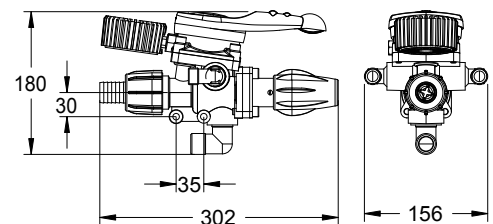

KIT DRIVER - 06



Gruppo di comando elettrico proporzionale a 5 vie.
Completo di: scatola di comando, cablaggi e raccordi.

Composizione del kit:

- Gruppo di comando;
- Scatola di comando;
- Cablaggi;
- Raccordi IN, OUT e BY-PASS.

5-way Electric control unit with control panel,
connecting cables and fittings.

Kit composed of:

- Control unit;
- Control panel;
- Connecting cables;
- Fittings IN, OUT and BY-PASS.

Пропорциональный электрический блок управления
на 5 линий. Снабжен распределительной коробкой,
электрокабелями и фитингами.

Комплектация:

- Блок управления;
- Распределительная коробка;
- Кабели;
- Фитинги IN/вход, OUT/выход и BY-PASS/байпасс.



Part No.	Valves	I/I'	bar	°C	V dc	Pack
8376C0136	5	150	20	60	12	1

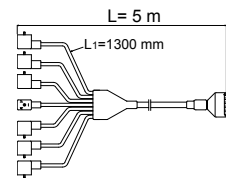
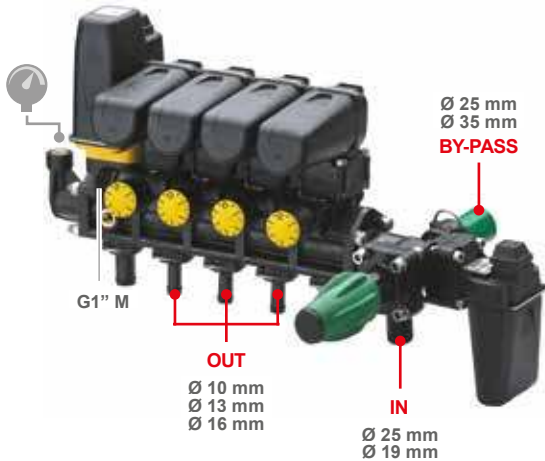

OPTIONALS



Pag. 346

KIT DRIVER - 06



Gruppo di comando elettrico proporzionale a 3/5 vie.
Completo di: scatola di comando, manometro,
cablaggi, raccordi e spina alimentazione
accendisigari.

Composizione del kit:

- Gruppo di comando;
- Scatola di comando;
- Manometro;
- Cablaggi;
- Raccordi IN, OUT e BY-PASS;
- Spina alimentazione accendisigari.

3/5-way Electric control unit with control panel,
pressure gauge, connecting cables, fittings and
cigarette lighter power plug.

Kit composed of:

- Control unit;
- Control panel;
- Pressure gauge;
- Connecting cables;
- Fittings IN, OUT and BY-PASS;
- Cigarette lighter power plug.

Пропорциональный электрический блок
управления на 3/5 линий. Снабжен
распределительной коробкой, манометром,
электрокабелями, фитингами и розеткой питания.

Комплектация:

- блок управления
- распределительная коробка
- манометр
- кабели
- фитинги IN/вход, OUT/выход и BY-PASS/байпасс
- розетка питания с прикуривателем



Part No.	Valves	I/I'	bar	°C	V dc	Pack
8376C0040	3	150	20	60	12	1
8376C0041	5	150	20	60	12	1

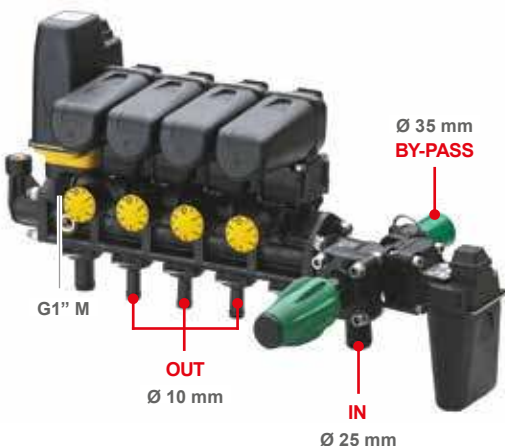

Isometric pressure gauge included

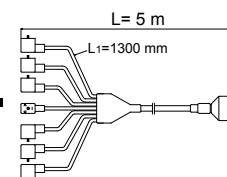

Cigarette lighter power plug



Distributore a valvole modulari manuali compensate con valvola di comando generale ON/OFF, valvola regolatrice di massima pressione a membrana, valvola regolatrice volumetrica e dispositivo di risucchio antigoccia. Indicato per chi desidera distribuire in modo semplice ed affidabile la giusta dose di prodotto, proporzionalmente ai giri del motore (RPM) nell'ambito della stessa marcia.

Per completare il comando è necessario scegliere i portagomma di entrata, uscita e by-pass.

Manual control unit with metered modular valves, main ON/OFF valve, diaphragm pressure relief adjustable valve, volumetric control valve and anti-drip back suction device. Suitable for an accurate distribution of chemicals proportionally to the engine r.p.m. (RPM) with same gear.

When ordering specify diameter of inlet, outlet and by-pass hoses you need.

Распределитель с компенсационными ручными модульными клапанами с главным клапаном управления ON/OFF, диафрагменным регулировочным клапаном максимального давления, регулировочным дозирующим клапаном и всасывающим противоклапельным устройством. Обеспечивает распределение соответствующего количества продукта, пропорционально оборотам двигателя на одной передаче. Для комплектации системы управления необходимо выбрать входной, выходной штуцер, байпас и манометр.

ST/BASIC 206

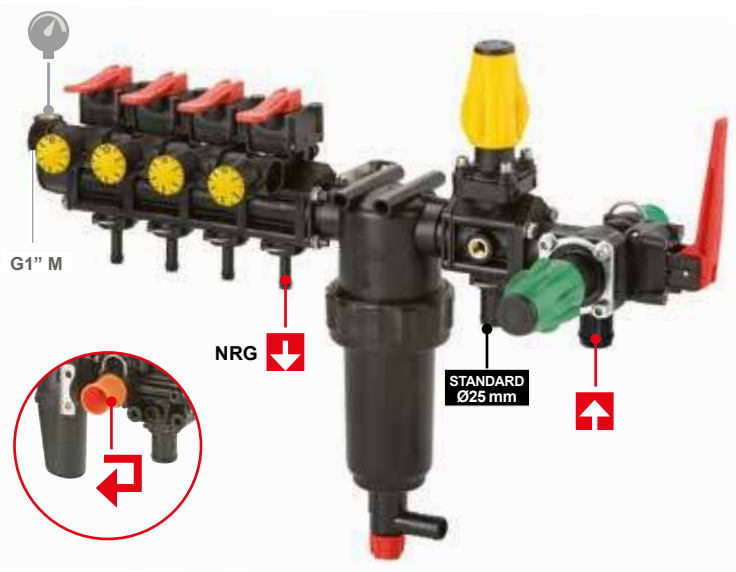

Complete control unit: Pag. 140

Part No.	Valves	I/1'	bar	°C	Pack
8376107	2				1
8376072	3				1
8376073	4	180	15	60	1
8376074	5				1
8376075	6				1
8376141	7				1

Obbligatorio ordinare i raccordi separatamente.
Compulsory: fitting to be ordered separately.
Обязательно: заказывать фитинги отдельно

IN Pag. 101 **OUT** Pag. 103 **BY-PASS** Pag. 101

OPTIONALS

Pag. 346

BASIC 206

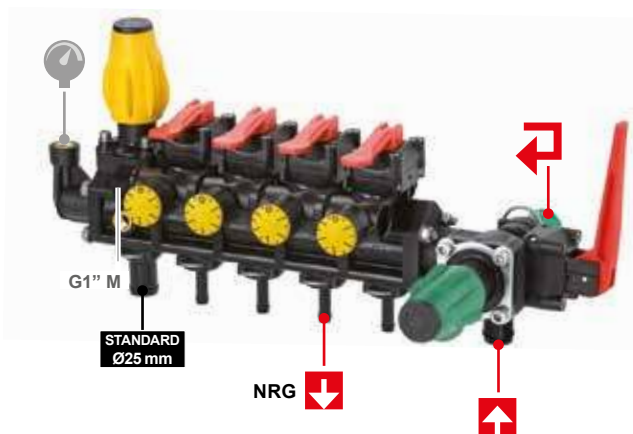

Complete control unit: Pag. 140

Part No.	Valves	I/1'	bar	°C	Pack
8376106	2				1
8376068	3				1
8376069	4	180	20	60	1
8376070	5				1
8376071	6				1
8376142	7				1

Obbligatorio ordinare i raccordi separatamente.
Compulsory: fitting to be ordered separately.
Обязательно: заказывать фитинги отдельно

IN Pag. 101 **OUT** Pag. 103 **BY-PASS** Pag. 101

OPTIONALS

Pag. 346

ST/START 06



Distributore a valvole modulari manuali con valvola di comando generale ON/OFF, valvola regolatrice di massima pressione a membrana e dispositivo di risucchio antigoccia. Disponibile nelle versioni con e senza filtro.

Per completare il comando è necessario scegliere i porta-gomma di entrata, uscita e by-pass.

Manual control unit with modular valves, main ON/OFF valve, diaphragm pressure relief adjustable valve and anti-drip back suction device. Available with or without filter.

When ordering specify diameter of inlet, outlet and by-pass hoses you need.

Распределитель с ручными модульными клапанами с главным клапаном управления ON/OFF, диафрагменным регулировочным клапаном максимального давления и всасывающим противокпельным устройством. Предусмотрен с фильтром или без него. Для комплектации системы управления необходимо выбрать входной, выходной штуцер, байпас и манометр.

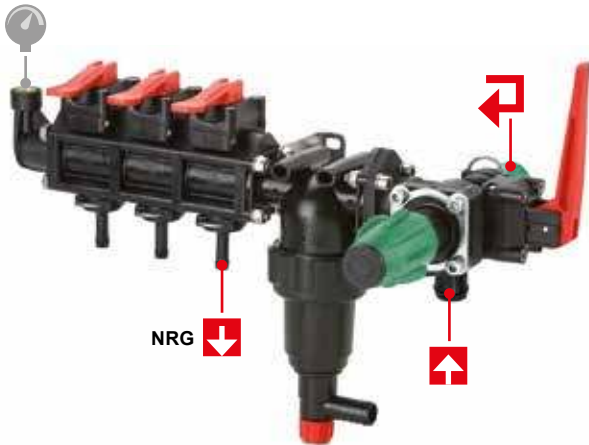

Complete control unit: Pag. 141

OPTIONALS



Pag. 346

Part No.	Valves	I/1'	bar	°C	Pack
8374038	2	180	20	60	1
8374039	3				1
8374040	4				1
8374041	5				1
8374042	6				1
8374053	7				1

Obbligatorio ordinare i raccordi separatamente.
Compulsory: fitting to be ordered separately.
Обязательно: заказывать фитинги отдельно

IN



Pag. 101

OUT



Pag. 103

BY-PASS



Pag. 101

START 06

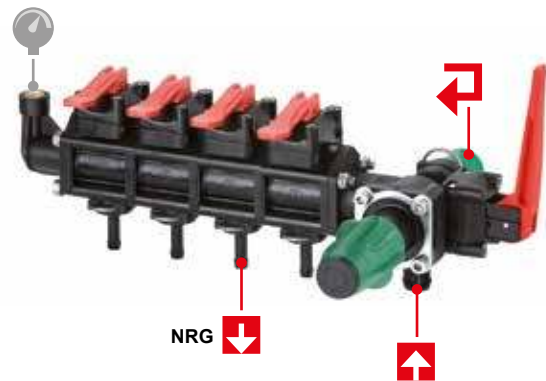

Complete control unit: Pag. 141

OPTIONALS



Pag. 346

Part No.	Valves	I/1'	bar	°C	Pack
8374033	2	180	20	60	1
8374034	3				1
8374035	4				1
8374036	5				1
8374037	6				1
8374054	7				1

Obbligatorio ordinare i raccordi separatamente.
Compulsory: fitting to be ordered separately.
Обязательно: заказывать фитинги отдельно

IN



Pag. 101

OUT



Pag. 103

BY-PASS



Pag. 101

START 08

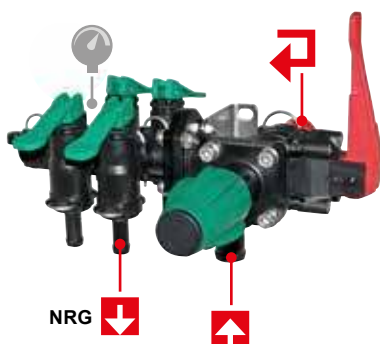

Complete control unit: Pag. 141

OPTIONALS



Pag. 346

Part No.	Valves	I/1'	bar	°C	Pack
8374048	2	180	20	60	1
8374049	3				1
8374050	4				1
8374051	5				1
8374052	6				1

Obbligatorio ordinare i raccordi separatamente.
Compulsory: fitting to be ordered separately.
Обязательно: заказывать фитинги отдельно

IN



Pag. 101

OUT



Pag. 103

BY-PASS



Pag. 101

ECOSTAR



Gruppi di comando a pressione costante.
Per completare il comando è necessario scegliere i porta-gomma di entrata, uscita e by-pass.

Constant pressure control units.
When ordering specify diameter of outlet hoses you need.

Блоки управления работающие при постоянном давлении.
Для комплектации системы необходимо заказывать отдельно фитинги: входной, выходной и байпас.

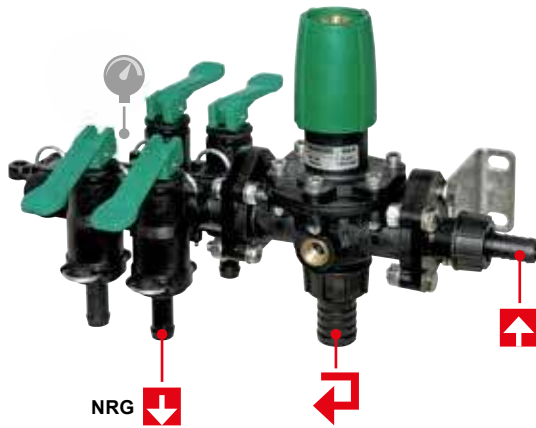

Complete control unit: Pag. 141

OPTIONALS



Pag. 346

Part No.	Valves	I/I'	bar	°C	Pack
8374044	2				1
8374045	3	180	20	60	1
8374046	4				1
8374047	5				1

Obbligatorio ordinare i raccordi separatamente.
Compulsory: fitting to be ordered separately.
Обязательно: заказывать фитинги отдельно



Pag. 103

IN	P/N	Ø mm	Image
↓	8002200	13	
↓	8002201	15	
↓	8002202	19	
↑	8012200	13	
↑	8012201	15	
↑	8012203	19	
BY-PASS	P/N	Ø mm	Image
↺	8002252	19	
↺	8002253	22	
↺	8002254	25	

NRG



Gruppo elettrovalvole NRG, con ritorni regolabili, e valvola volumetrica regolabile elettricamente.

Electric control unit NRG with by-pass manifold and volumetric regulating valve.

Блок электроклапанов NRG с регулируемым возвратом и дозирующим клапаном с электрической системой управления.



OPTIONALS



Pag. 346



Pag. 62



Pag. 40→45



Pag. 110

Part No.	Valves	bar	Ø mm	°C	V dc	Pack
8372032	2		19			1
8372033	3		19			1
8372034	4	20	25	60	12	1
8372035	5		25			1
8372036	6		25			1
8372037	7		25			1

Obbligatorio ordinare i raccordi separatamente.
Compulsory: fitting to be ordered separately.
Обязательно: заказывать фитинги отдельно



Pag. 103

ADAPTERS



Pag. 112

I collegamenti con valvole generali VGM 4 e VGME 4, non necessitano di flange di accoppiamento.



No coupling discs are required for connections with the general valves VGM4 and VGME4.

Соединения с главными клапанами VGM4 и VGME4 не нуждаются в соединительных фланцах.

NRG



Gruppo elettrovalvole NRG con ritorni registrabili.

Electric control unit NRG with by-pass manifold.

Блок электроклапанов NRG с регулируемыми возвратами.

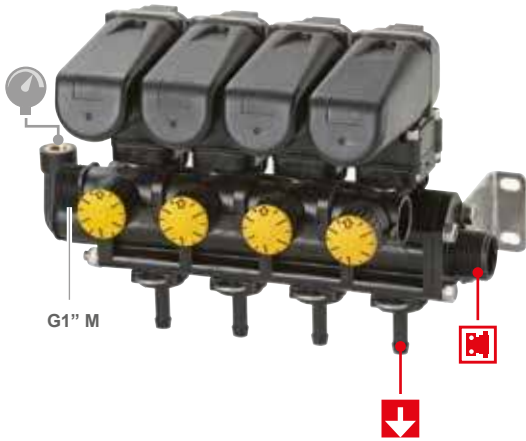

Part No.	Valves	bar	sec	°C	V dc	Pack
8372026	2					
8372027	3					
8372028	4	20	0,2	60	12	1
8372029	5					
8372030	6					
8372031	7					

OPTIONALS

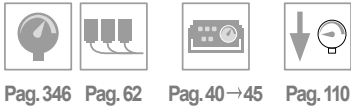

Pag. 346 Pag. 62 Pag. 40→45 Pag. 110

I collegamenti con valvole generali VGM 4 e VGME 4, non necessitano di flange di accoppiamento.

No coupling discs are required for connections with the general valves VGM4 and VGME4.

Соединения с главными клапанами VGM4 и VGME4 не нуждаются в соединительных фланцах.

Obbligatorio ordinare i raccordi separatamente.
Compulsory: fitting to be ordered separately.
Обязательно: заказывать фитинги отдельно

OUT Pag. 103 **ADAPTERS** Pag. 112

NRG



Gruppo elettrovalvole NRG on/off.

Electric control unit NRG.

Блок электроклапанов NRG.

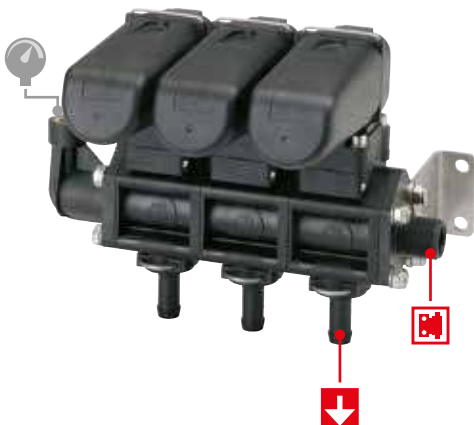

Part No.	Valves	bar	sec	°C	V dc	Pack
8372020	2					
8372021	3					
8372022	4	20	0,2	60	12	1
8372023	5					
8372024	6					
8372025	7					
8372066	9					

OPTIONALS

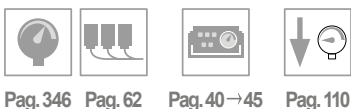

Pag. 346 Pag. 62 Pag. 40→45 Pag. 110

I collegamenti con valvole generali VGM 4 e VGME 4, non necessitano di flange di accoppiamento.

No coupling discs are required for connections with the general valves VGM4 and VGME4.

Соединения с главными клапанами VGM4 и VGME4 не нуждаются в соединительных фланцах.

Obbligatorio ordinare i raccordi separatamente.
Compulsory: fitting to be ordered separately.
Обязательно: заказывать фитинги отдельно

OUT Pag. 103 **ADAPTERS** Pag. 112

NRG



Distributore manuale con rubinetti modulari compensati e valvola volumetrica. Per completare il distributore è necessario scegliere i portagomma di uscita.

Modular valve manual control unit with metered by-pass manifold and volumetric regulating valve. When ordering specify outlet hoses you need.

Ручной распределитель с модульными компенсационными кранами и дозирующим клапаном. Для комплектации распределителя необходимо выбрать выходной штуцер.

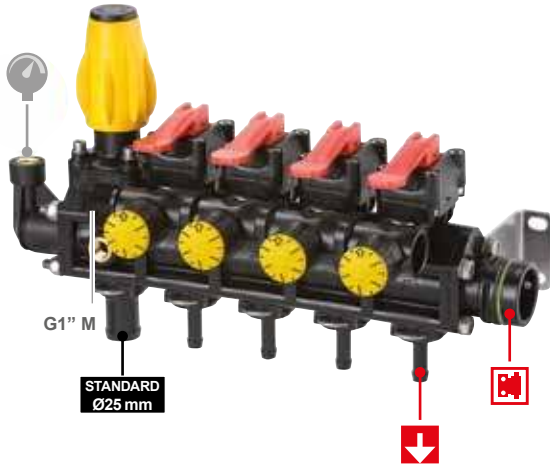

Part No.	Valves	bar	°C	Connection	Pack
8372040	3	20	60	QUICK	1
8372041	4				1
8372042	5				1
8372043	6				1

Obbligatorio ordinare i raccordi separatamente.
Compulsory: fitting to be ordered separately.
Обязательно: заказывать фитинги отдельно

OUT



Pag. 103

ADAPTERS



Pag. 112

Adatto per / Suitable to / Пригоден для

VGM 2



VGM 3



VGME 5



OPTIONALS



Pag. 346

NRG



Distributore manuale con rubinetti modulari. Per completare il distributore è necessario scegliere i portagomma di uscita.

Modular valves ON/OFF manual unit. When ordering specify outlet hoses you need.

Ручной распределитель с модульными кранами. Для комплектации распределителя необходимо выбрать выходной штуцер.

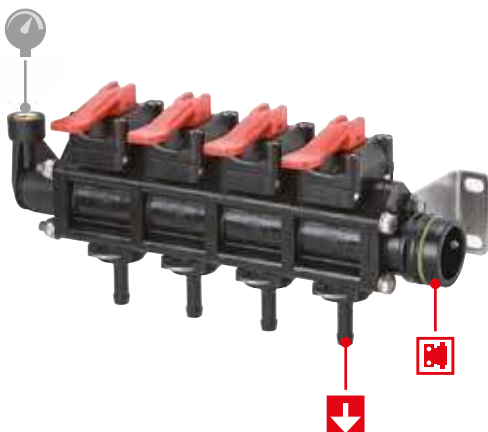

Part No.	Valves	bar	°C	Connection	Pack	
8372044	2	20	60	QUICK	1	
8372045	3				1	
8372046	4				1	
8372047	5				1	
8372048	6				1	
8372049	2				1	
8372050	3				1	
8372051	4				G 1 1/4	1
8372052	5				1	
8372053	6				1	

Obbligatorio ordinare i raccordi separatamente.
Compulsory: fitting to be ordered separately.
Обязательно: заказывать фитинги отдельно.

OUT



Pag. 103

ADAPTERS



Pag. 112

Adatto per / Suitable to / Пригоден для

VGM 2



VGM 3



VGME 5



OPTIONALS



Pag. 346

Distributore manuale con rubinetti modulari.
Per completare il distributore è necessario scegliere i portagomma di uscita.

Modular valves ON/OFF manual unit.
When ordering specify outlet hoses you need.

Ручной распределитель с модульными кранами.
Для комплектации распределителя необходимо выбрать выходной штуцер.



Part No.	Valves	bar	°C	Connection	Pack
8372000	2				1
8372001	3				1
8372002	4	20	60	QUICK	1
8372003	5				1
8372004	6				1

Adatto per / Suitable to / Пригоден для

VGM 2

VGM 3

VGME 5



OPTIONALS



Pag. 346

Obbligatorio ordinare i raccordi separatamente.
Compulsory: fitting to be ordered separately.
Обязательно: заказывать фитинги отдельно.

OUT

↓ Pag. 103



Part No.	Valves	bar	°C	Connection	Pack
8372056	2				1
8372057	3				1
8372058	4	20	60	G 1 M	1
8372059	5				1
8372060	6				1

OPTIONALS



Pag. 346

Obbligatorio ordinare i raccordi separatamente.
Compulsory: fitting to be ordered separately.
Обязательно: заказывать фитинги отдельно.

OUT

↓ Pag. 103



Part No.	Valves	bar	°C	Connection	Pack
8372061	2				1
8372062	3				1
8372063	4	20	60	NRG	1
8372064	5				1
8372065	6				1

Adatto per / Suitable to / Пригоден для

VGM 4

VGME 4



OPTIONALS



Pag. 346

Obbligatorio ordinare i raccordi separatamente.
Compulsory: fitting to be ordered separately.
Обязательно: заказывать фитинги отдельно.

OUT

↓ Pag. 103



Valvola elettrica di comando generale (ad azionamento elettrico) con valvola regolabile di massima pressione (manuale).
Valvole di regolazione volumetriche manuali.

Electric main control valve with manual adjustable pressure relief valve.
Manual volumetric control valves.

Главный электрический клапан управления (с электроприводом) с регулируемым клапаном максимального давления (ручной).
Ручные дозирующие регулировочные клапаны.

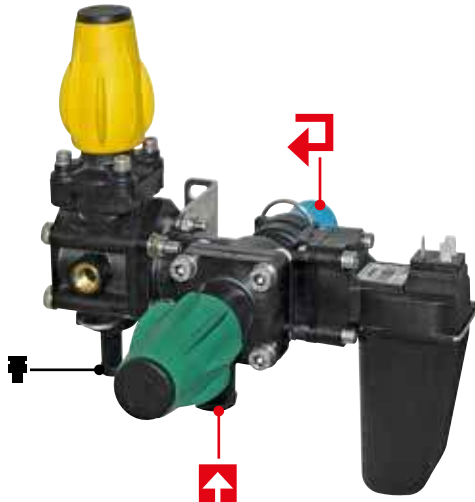

Part No.	l/1'	bar	NRG model	°C	V dc	Ø mm	Pack
8380018	180	20	NRG 72			13	1
8380019	180	20	NRG 70	60	12	19	1
8380020	180	20	NRG 74			25	1

Obbligatorio ordinare i raccordi separatamente.
Compulsory: fitting to be ordered separately.
Обязательно: заказывать фитинги отдельно.

IN
Pag. 101

BY-PASS
Pag. 101

OPTIONALS



Pag. 62



Pag. 40→45



Pag. 112

GS VGME 5

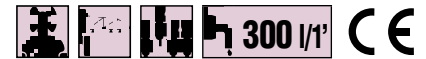

Valvola manuale di comando generale (ad azionamento elettrico) con valvola regolabile di massima pressione (manuale).
Valvola di regolazione volumetrica elettrica.

Manual main control valve with manual adjustable pressure relief valve.
Electric volumetric control valve.

Главный ручной клапан управления (с электроприводом) с регулируемым клапаном максимального давления (ручной).
Электрический дозирующий регулировочный клапан.

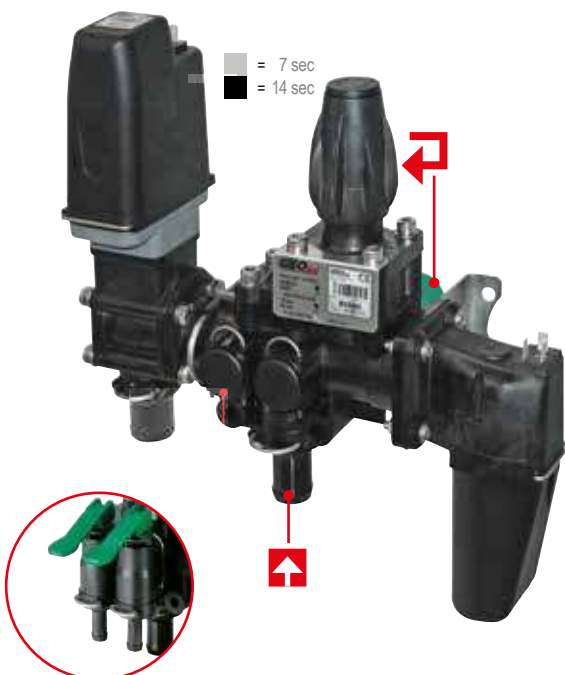

Part No.	l/1'	bar	sec	NRG model	No. of wires	°C	V dc	Pack
8380021	300	10	7	NRG 26	2			1
8380023	300	20	7	NRG 26	2	60	12	1
8380022	300	10	14	NRG 26	2			1
8380024	300	20	14	NRG 26	2	60	12	1

Obbligatorio ordinare i raccordi separatamente.
Compulsory: fitting to be ordered separately.
Обязательно: заказывать фитинги отдельно.

IN
Pag. 101

BY-PASS
Pag. 101

OPTIONALS



Pag. 62



Pag. 40→45



Pag. 112

P/N K00102000
Rubinetti modulari
Modular valves
Мод.клапаны

GS VGME 4



Valvola elettrica di comando generale (ad azionamento elettrico) con valvola regolabile di massima pressione (manuale).
Valvola di regolazione volumetrica elettrica.

Electric main control valve with manual adjustable pressure relief valve.
Electric volumetric control valve.

Главный электрический клапан управления (с электроприводом) с регулируемым клапаном максимального давления (ручной).
Электрический дозирующий регулировочный клапан.

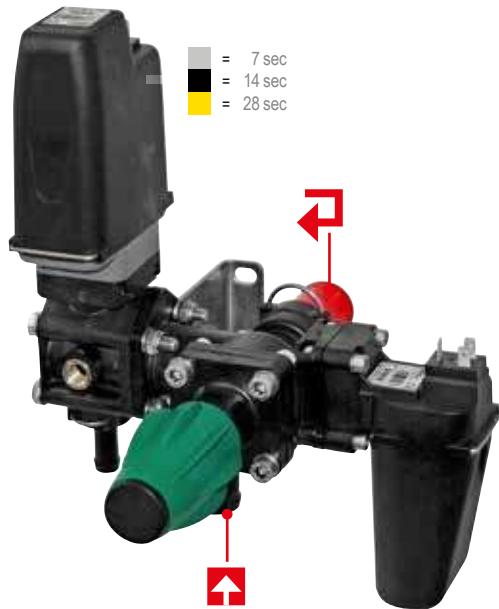

Part No.	l/1'	bar	sec	Ø mm	NRG model	°C	V dc	Pack
8380000	180	20	7	13	NRG 022S			
8380001	180	20	7	19	NRG 020	60	12	1
8380002	180	20	7	25	NRG 024			
8380003	180	20	14	13	NRG 022			
8380004	180	20	14	19	NRG 020	60	12	1
8380005	180	20	14	25	NRG 024			
8380006	180	20	28	13	NRG 022			
8380007	180	20	28	19	NRG 020	60	12	1
8380008	180	20	28	25	NRG 024			

Suitable for 2 and 3 wires electric controls

OPTIONALS



Pag. 62



Pag. 40→45



Pag. 112



Pag. 8→35



Obbligatorio ordinare i raccordi separatamente.
Compulsory: fitting to be ordered separately.
Обязательно: заказывать фитинги отдельно.



Pag. 101

BY-PASS



Pag. 101

VGME 4



Valvola elettrica di comando generale (ad azionamento elettrico) con valvola regolabile di massima pressione (manuale).

Electric main control valve with manual adjustable pressure relief valve.

Главный электрический клапан управления (с электроприводом) с регулируемым клапаном максимального давления (ручной).



Part No.	l/1'	bar	sec	°C	V dc	Pack
8370029	<60	20				1
8370014		10	0,2	60	12	1
8370015	180	20				1
8370016		30				1

Suitable for 2 and 3 wires electric controls

OPTIONALS



Pag. 62



Pag. 40→45



Pag. 8→35



Obbligatorio ordinare i raccordi separatamente.
Compulsory: fitting to be ordered separately.
Обязательно: заказывать фитинги отдельно.



Pag. 101

BY-PASS



Pag. 101

VGME 5



Valvola manuale di comando generale (ad azionamento elettrico) con valvola regolabile di massima pressione (manuale).

Manual main control valve with manual adjustable pressure relief valve.

Главный ручной клапан управления (с электроприводом) с регулируемым клапаном максимального давления (ручной).



Part No.	l/1'	bar	sec	°C	V dc	Pack
8370021	300	10	0,5	60	12	1
8370022		20				1

Suitable for 2 and 3 wires electric controls

Obbligatorio ordinare i raccordi separatamente.
Compulsory: fitting to be ordered separately.
Обязательно: заказывать фитинги отдельно.

IN Pag. 101 **BY-PASS** Pag. 101 **ADAPTERS** Pag. 112

OPTIONALS

Pag. 62 Pag. 40→45 Pag. 112

P/N K00102000
Rubinetti modulari
Modular valves
Мод. клапаны

VGME 5



Valvola manuale di comando generale (ad azionamento elettrico) con valvola regolabile di massima pressione (manuale).

Manual main control valve with manual adjustable pressure relief valve.

Главный ручной клапан управления (с электроприводом) с регулируемым клапаном максимального давления (ручной).

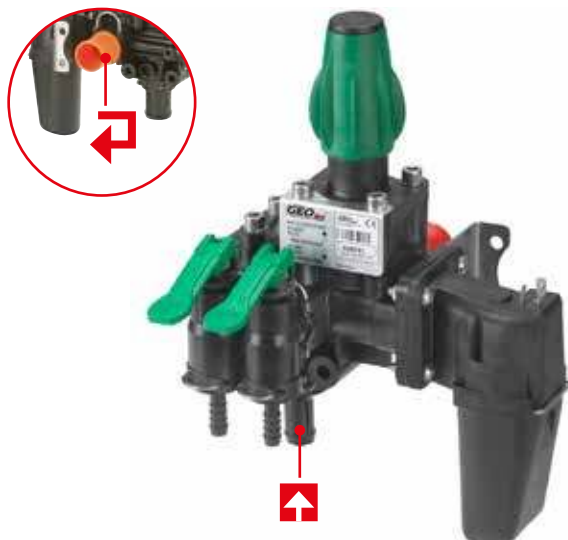

Part No.	l/1'	bar	sec	°C	V dc	Pack
8370024	300	20	0,5	60	12	1

Suitable for 2 and 3 wires electric controls

Obbligatorio ordinare i raccordi separatamente.
Compulsory: fitting to be ordered separately.
Обязательно: заказывать фитинги отдельно.

IN Pag. 101 **BY-PASS** Pag. 101 **ADAPTERS** Pag. 112

OPTIONALS

Pag. 62 Pag. 40→45 Pag. 112

VGM 4



Valvola di comando generale manuale con valvola regolabile di massima pressione manuale.

Manual main control valve with manual adjustable pressure relief valve.

Главный ручной клапан управления с регулируемым клапаном максимального давления.



Part No.	l/1'	bar	°C	Pack
8370031	<60	20	60	1
8370011		10		1
8370012	180	20		1
8370013		30		1

Obbligatorio ordinare i raccordi separatamente.
Compulsory: fitting to be ordered separately.
Обязательно заказывать фитинги отдельно.

IN
Pag. 101

BY-PASS
Pag. 101





IN

Kit portagomma di entrata.

Inlet hosetail kit.

Комплект входного штуцера.

Suitable for:



Type	Part No.	Ø	Gasket	Pack
	8392028	19 mm		1
	8392029	25 mm	G00001029	1
	8392030	35 mm		1



Type	Part No.	Ø	Gasket	Pack
	8392072	G 3/4 M		1
	8392074	G 1 M	G00001158	1
	8392085	1" NPT F		1
	8392084	19 mm		1
	8392073	25 mm	G00001158	1
	8392081	30 mm		1
	8392082	32 mm		1
	8392083	25 mm	G00001158	1



BY-PASS

Kit portagomma di scarico.



By-pass hosetail kit.

Комплект спускного штуцера.

Suitable for:



RISUCCHIO / ANTI-DRIPSYSTEM / АНТИВИХРЬ

Type	Part No.	Ø	I/I' MAX	Gasket	Pack
	8392025	35 mm	60	G00001029	1
	8392026	35 mm	120		
	8392027	35 mm	250		
	8392063	40 mm	300		
	8392031	G 1 M	60	G00001029	1
	8392032	G 1 M	120		
	8392033	G 1 M	250		

Filettato / Threaded / Резьб

Type	Part No.	Ø	I/I' MAX	Gasket	Pack
	8392028	19 mm	200	G00001029	1
	8392029	25 mm	250		
	8392030	35 mm	300		

Valvola elettrica On/Off di sezione per barra.

On/Off electric section valve for spraying boom and orchard sprayers.

Электрический секционный клапан On/Off для штанги.

NRG PLUS 001



Part No.	l/1'	bar	sec	°C	V dc	Pack
8388003	120*	20	0,20	60	12	1

Suitable for 2 and 3 wires electric controls

NRG PLUS 011



Part No.	l/1'	bar	sec	°C	V dc	Pack
8388004	120*	20	0,20	60	12	1

Suitable for 2 and 3 wires electric controls



Obbligatorio ordinare i raccordi separatamente.
Compulsory: fitting to be ordered separately.
Обязательно: заказывать фитинги отдельно.

OUT
Pag. 103

OPTIONALS



Pag. 62



Pag. 40→45



Pag. 112



Pag. 113



Pag. 8→35

* Valore variabile in funzione del diametro del portagomma, con pressione di 0,5bar.
* Value varies depending on diameter of hose-tail, with 0,5bar pressure.
* Значение зависит от диаметра штуцера при давлении 0,5 бар.



A 3 VIE / 3-WAY / 3-ХОД.

NRG 001



Part No.	l/1'	bar	sec	°C	V dc	Pack
8388000	15*+45*	20	0,20	60	12	1

Suitable for 2 and 3 wires electric controls

NRG 011



Part No.	l/1'	bar	sec	°C	V dc	Pack
8388001	15*+45*	20	0,20	60	12	1

Suitable for 2 and 3 wires electric controls



Obbligatorio ordinare i raccordi separatamente.
Compulsory: fitting to be ordered separately.
Обязательно: заказывать фитинги отдельно.

OUT
Pag. 103

OPTIONALS



Pag. 62



Pag. 40→45



Pag. 112



Pag. 113



Pag. 8→35

* Valore variabile in funzione del diametro del portagomma, con pressione di 0,5bar.
* Value varies depending on diameter of hose-tail, with 0,5bar pressure.
* Значение зависит от диаметра штуцера при давлении 0,5 бар.



A 3 VIE / 3-WAY / 3-ХОД.

Valvola manuale On/Off di sezione per barra.

Manual On/Off section valve for spraying boom and orchard sprayers.

Ручной секционный клапан On/Off для штанги.

NRG 051



Part No.	I/I'	bar	°C	Pack
8388006	15* ÷ 45*	20	60	1



Obbligatorio ordinare i raccordi separatamente.
Compulsory: fitting to be ordered separately.
Обязательно: заказывать фитинги отдельно.

OUT
Pag. 103

OPTIONALS



Pag. 112



Pag. 113



Pag. 114

* Valore variabile in funzione del diametro del portagomma, con pressione di 0,5bar.
* Value varies depending on diameter of hose-tail, with 0,5bar pressure.
* Значение зависит от диаметра штуцера при давлении 0,5 бар.

NRG 061

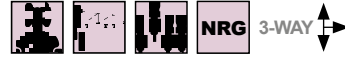

Part No.	I/I'	bar	°C	Pack
8388007	15* ÷ 45*	20	60	1



A 3 VIE / 3-WAY / 3-ХОД.

OUT

Raccordi d'uscita per valvole sezione barra.
O-ring non incluso nei raccordi.
Da ordinare separatamente

Boom section valves hosesails.
O-ring not included with fittings.
To be ordered separately

Выходные фитинги для секционных клапанов штанги.
Круглая резиновая прокладка не включена.
Заказывается отдельно.

OUT → NRG PLUS series

Part No.	Ø mm	Type	Pack
G00001021	/	OR Viton®	50
R00000074	19		1
R00000098	25		1
R00000076	30		1
R00000078	Ø25 mm	90° →	1
R00000093	G 3/4 M		1
R00000097	G1 M		1
R00000075	1 NPT F		1

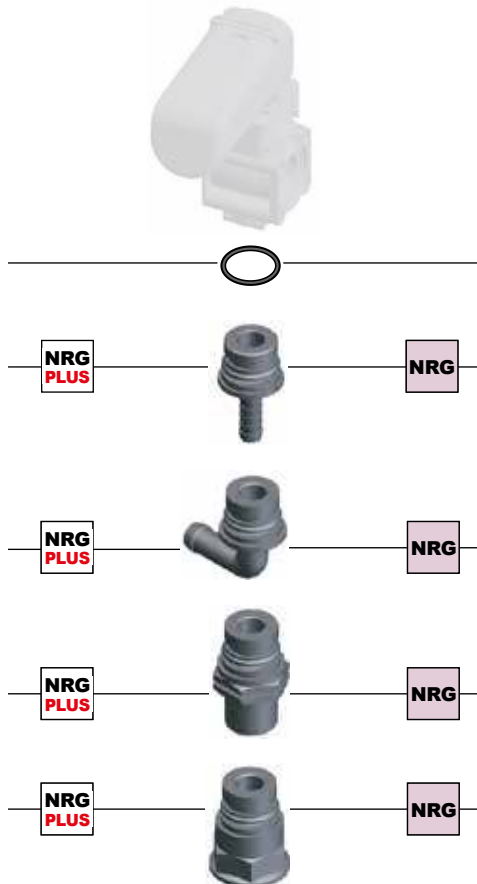

OUT → NRG series

Part No.	Ø mm	Type	Pack
G00001059	/	OR Viton®	50
R00000014	10		1
R00000015	13		1
R00000016	16		1
R00000017	19		1
R00000018	25		1
✓ R00000019	25	Øi16	1
R00000082	13	90° →	1
R00000255	10		1
R00000083	G 3/4 M		1
✓ R00000122	G 3/4 M	Øi16	1
* R00000066	G 1/2 M		1
R00000084	G 3/4 F		1
R00000085	3/4 NPT F		1

* Ottone / Brass / Латунь
✓ Only for VOLUMETRIC VALVES

Valvola elettrica On/Off di sezione per barra.
Completa di raccordo d'uscita in ottone.

On/Off electric section valve for spraying boom and
orchard sprayers. Brass outlet hosetails included.

Электрический секционный клапан On/Off
для штанги. В комплектации с латунным
выходным фитингом.

NRG 001



Part No.	I/1'	bar	sec	°C	V dc	Pack
8545017	25*	40	0,20	60	12	1

Suitable for 2 and 3 wires electric controls

NRG 011



Part No.	I/1'	bar	sec	°C	V dc	Pack
8545018	25*	40	0,20	60	12	1

Suitable for 2 and 3 wires electric controls

OPTIONALS



Pag. 62



Pag. 40-45



Pag. 112



Pag. 113



Pag. 114



Pag. 8-35

* Valore variabile in funzione del diametro del portagomma, con pressione di 0,5bar.
* Value varies depending on diameter of hose-tail, with 0,5bar pressure.
* Значение зависит от диаметра штуцера при давлении 0,5 бар.



G1/2 M



G1/2 M

A 3 VIE / 3-WAY / 3-ХОД.

Valvola manuale On/Off di sezione per barra.
Completa di raccordo d'uscita in ottone.

Manual On/Off section valve for spraying boom
and orchard sprayers. Brass outlet hosetails
included.

Ручной секционный клапан On/Off для
штанги. В комплектации с латунным
выходным фитингом.

NRG 051



Part No.	I/1'	bar	°C	Pack
8550008	25	40	60	1



G1/2 M

OPTIONALS



Pag. 112



Pag. 113



Pag. 114

NRG 061



Part No.	I/1'	bar	°C	Pack
8550009	25	40	60	1



G1/2 M

A 3 VIE / 3-WAY / 3-ХОД.

Valvola elettrica di scarico serie NRG.
Completa di raccordo d'uscita in ottone.

Electric dump valve NRG series.
Brass outlet hoseetails included.

Электрический спускной клапан серии NRG.
В комплектации с латунным выходным
соединением.

OPTIONALS



Pag. 62 Pag. 40→45 Pag. 112 Pag. 113 Pag. 8→35



G3/4 M

NRG DUMP

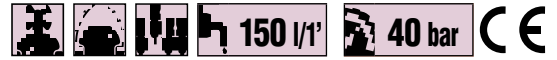

Part No.	l/1'	bar	sec	°C	V dc	Pack
8370026	150	40	0,20	60	12	1

Suitable for 2 and 3 wires electric controls

Valvola di regolazione volumetrica elettrica.
Electric volumetric control valve.
Электрический дозирующий
регулирующий клапан.

■ = 7 sec
■ = 14 sec

OPTIONALS



Pag. 62 Pag. 40→45 Pag. 112 Pag. 113 Pag. 8→35

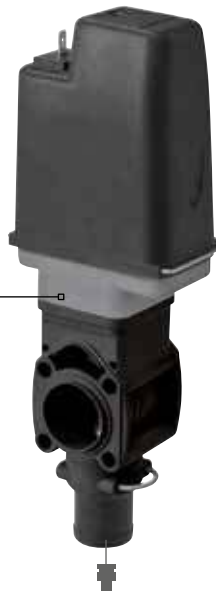

020S

020 14S

NRG PLUS 026



Part No.	l/1'	bar	sec	Ø	°C	V dc	Pack
8386009	240	20	7	30 mm	60	12	1
8386008	240	20	14	30 mm			

Valvola di regolazione volumetrica elettrica.
Electric volumetric control valve.
Электрический дозирующий
регулирующий клапан.

■ = 7 sec
■ = 14 sec
■ = 28 sec

OPTIONALS

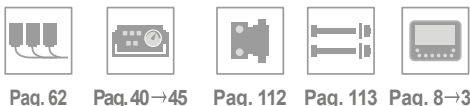

Pag. 62 Pag. 40→45 Pag. 112 Pag. 113 Pag. 8→35



NRG 022S

NRG 020

NRG 024

NRG 024 7S 40bar

NRG 022 14S

NRG 020 14S

NRG 024 14S

NRG 022

NRG 020

NRG 024

NRG serie 02_



Part No.	l/1'	bar	sec	Ø	°C	V dc	Pack
8386011	60	40	7	13 mm			
8386010	100	40	7	19 mm	60	12	1
8386006	150	20	7	25 mm			
8386017	200	40	7	G 3/4			
8386015	60	40	14	13 mm			
8386016	100	40	14	19 mm	60	12	1
8386023	200	40	14	G3/4			
8386003	60	40	28	13 mm			
8386004	100	40	28	19 mm	60	12	1
8386005	150	40	28	25 mm			

Valvole di regolazione volumetriche manuali.

Manual volumetric control valves.

Ручные дозирующие регулировочные клапаны.

NRG PLUS 076



Part No.	l/1'	Ø	bar	°C	Pack
8386007	240	30 mm	20	60	1

OPTIONALS



Pag. 112



Pag. 113



Attacchi flangiati per valvole serie NRG.
Flanged for NRG series valves.
Фланцевые соединения для клапанов серии NRG.

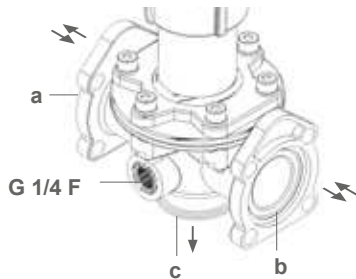

NRG serie 07_



Part No.	l/1'	Ø	bar	°C	Pack
8386000	60	13 mm			1
8386001	100	19 mm	40	60	1
8386002	150	25 mm			1

NRG 072
NRG 070
NRG 074

OPTIONALS



Pag. 112



Pag. 113



* flow ⇒ 1,5 bar



Part No.	l/1'*	bar	a	b	c	by-pass	°C	Pack
8386021	180	20	F	F	G1 M		60	1

OPTIONALS



Pag. 346



Pag. 112



Con attacchi filettati.
With threaded fittings.
С резьб. фитингами.

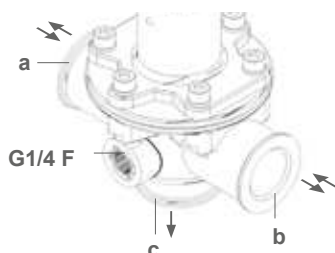

* flow ⇒ 1,5 bar



Part No.	l/1'*	bar	a	b	c	by-pass	°C	Pack
8386020	125	20	G 3/4 F	G 3/4 F	G 3/4 F			1
8386019	160	50	G 3/4 F	G 3/4 F	G 3/4 F		60	1
8386018	180	20	G1 M	G1 M	G1 M			1

OPTIONALS



Pag. 346



Pag. 112

Valvola regolazione pressione a membrana ad azionamento elettrico.

Electric diaphragm pressure relief valve.

Диафрагменный регулировочный клапан давления с электроприводом.

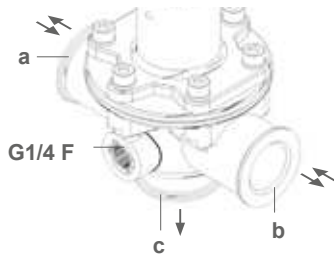

Con attacchi filettati.
With threaded fittings.
С резьб.фитингами.



Part No.	l/1'	bar	a	b	c	by-pass	°C	sec	Vdc	A	Pack
8384019		10									
8384020		20									
8384021	150	30	G 3/4 F	G 3/4 F	G 3/4 F		60	50	12	3	1
8384022		40									
8384023		50									
8384024	200	10	G 1 M	G 1 M	G 1 M		60	50	12	3	1
8384025		20									

OPTIONALS



Pag. 346 Pag. 62 Pag. 112

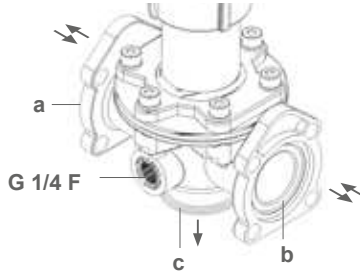

Attacchi flangiati per valvole serie NRG.
Flanged for NRG series valves.
Фланцевые соединения для клапанов серии NRG.

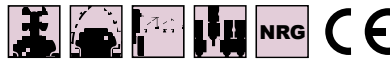

Part No.	l/1'	bar	a	b	c	by-pass	°C	sec	Vdc	A	Pack
8384026		30									
8384027	150	40				G 3/4 F					
8384028		10	M	F			60	50	12	2	1
8384029	200	20				G 1 M					

OPTIONALS

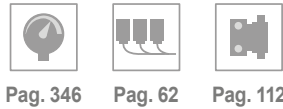

Pag. 346 Pag. 62 Pag. 112

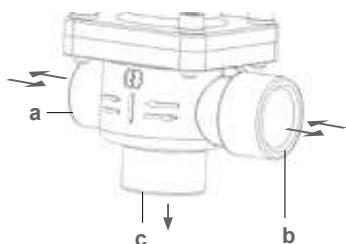

Part No.	l/1'	bar	a	b	c	by-pass	°C	sec	Vdc	A	Pack
8384034											
8384035	150	50	G 1/2 F	G 3/4 F	G 3/4 F		60	50	12	3	1
					G 1 M						

OPTIONALS

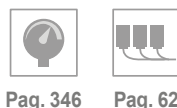

Pag. 346 Pag. 62

Valvola manuale regolazione pressione a membrana. *Manual diaphragm pressure relief valve.*

Диафрагменный ручной регулировочный клапан давления.

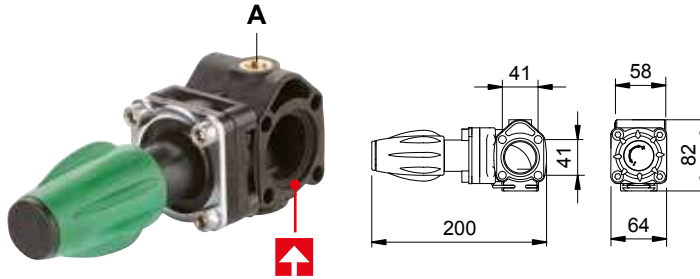

Obbligatorio ordinare i raccordi separatamente.
Compulsory: fitting to be ordered separately.
Обязательно: заказывать фитинги отдельно.

OUT
Pag. 103

NRG serie 68_



Part No.	l/1'	bar	°C	Pack
683 8384036		10	60	1
680 8384037		20		1
681 8384038	120	30		1
682 8384039		40		1

OPTIONALS



Pag. 346 Pag. 112 Pag. 113

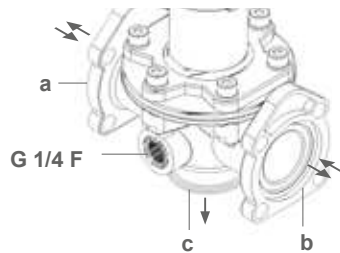

Attacchi flangiati per valvole serie NRG.
Flanged for NRG series valves.
Фланцевые соединения для клапанов серии NRG.



Part No.	l/1'	bar	by-pass	°C	Pack
8384015	150	30	G 3/4 F	60	1
8384016		40			1
8384017	200	10	G 1 M	60	1
8384018		20			1

OPTIONALS

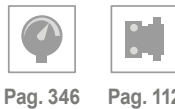

Pag. 346 Pag. 112

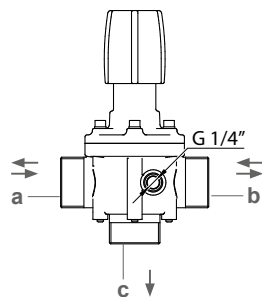

Con attacchi filettati.
With threaded fittings.
С резьб.фитингами.



Part No.	l/1'	bar	by-pass	°C	Pack
8384008		10			
8384009		20			
8384010	150	30	G 3/4 F	60	1
8384011		40	G 3/4 F		
8384012		50	G 3/4 F		
8384013	200	10	G 1 M	60	1
8384014		20	G 1 M		

OPTIONALS



Pag. 346

Valvola manuale regolazione pressione a membrana. *Manual diaphragm pressure relief valve.*

Диафрагменный ручной регулировочный клапан давления.

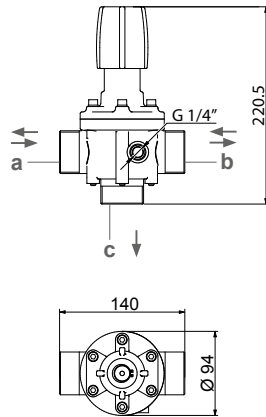

Con attacchi filettati.
With threaded fittings.
С резьбовыми фитингами.

Part No.	l/1'	bar	a	b	c	by-pass	°C	Pack
8384049	400	20	G 1 1/2 M	G 1 1/2 M	G 1 1/2 M		60	1

OPTIONALS



Pag. 346

Valvola manuale regolazione pressione a membrana, in ottone, con attacchi filettati. *Brass manual diaphragm pressure relief valve with threaded fittings.*

Ручной диафрагменный регулировочный клапан давления из латуни, с резьбовыми фитингами.

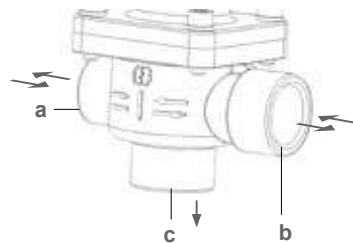

Part No.	l/1'	bar	a	b	c	by-pass	°C	Pack
8384030		30						
8384041		40	G 1/2 F	G 3/4 F	G 3/4 F			
8384031		50						
8384032	150	30					60	5
8384042		40	G 1/2 F	G 3/4 F	G 1 M			
8384033		50						

OPTIONALS



Pag. 346

Valvola di regolazione manuale di massima pressione. *Manual adjustable pressure relief valve.*

Ручной регулировочный клапан максимального давления.

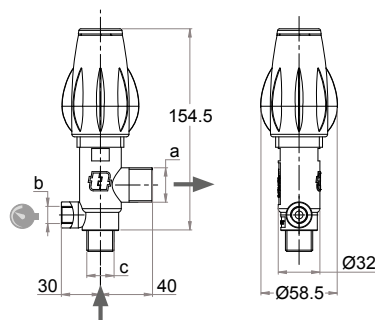

Part No.	l/1'	bar	a	b	c	by-pass	°C	Pack
8384043		4	G 3/4 M	G 1/4 F	G 1/2 M			
8384045					G 3/4 M			
8384044	70				G 1/2 M		60	20
8384046		10	G 3/4 M	G 1/4 F	G 3/4 M			

OPTIONALS



Pag. 346

Dispositivo scarico pressione ad azionamento meccanico - Valvole NRG

- Consente di azzerare la pressione residua del liquido che rimane intrappolato tra le valvole di sezione e valvola antigocciola, riducendo il gocciolamento;
- Azionamento a comando indotto dal motoriduttore della valvola;
- Montaggio modulare con attacco a forchetta per facilitare l'installazione e l'ispezione;
- Applicabile a tutti i gruppi Geoline.

Exhaust device with mechanical actuating - NRG Valves
- Used to bleed off the residual pressure of the liquid that remains trapped between the section valves and check valve, thus reducing dripping;
- Induced control drive via valve geared motor;
- Modular assembly with fork coupling for easier installation and inspection;
- Can be fitted and retrofitted to all electric Geoline control units.

Механическое разгрузочное устройство давления - клапанами NRG

- Позволяет обнулить остаточное давление жидкости, оставшейся между секционными клапанами и противокapельным клапаном, уменьшая объем капания;
- Активация за счет моторедуктора клапана;
- Модульный монтаж с вилочным креплением для содействия установке и проверке;
- Применяется со всеми модулями Geoline.



NEW

Part No.	bar	A	B	C	D	kg	Pack
8392086	20	NRG	AF5	AF3	AF5	0,2	1
8392100	20	AF3	AF5	AF3	AF5	0,2	1

DIMENSIONS

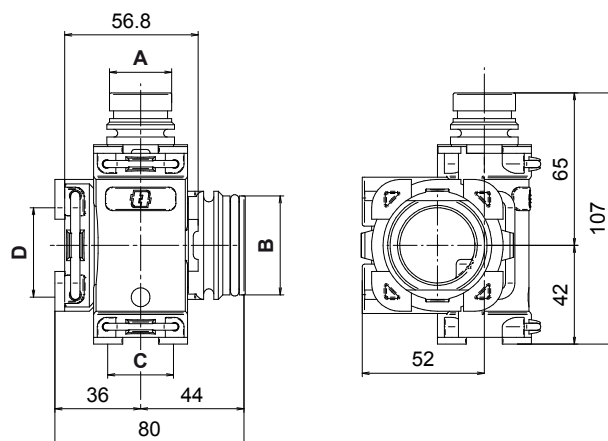

OPTIONALS



Pag. 73-75

MOUNTING

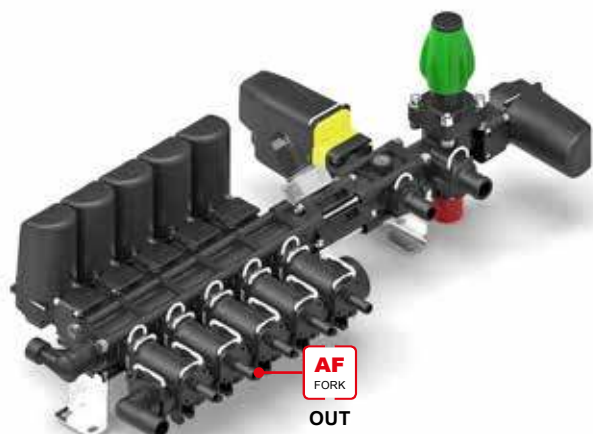
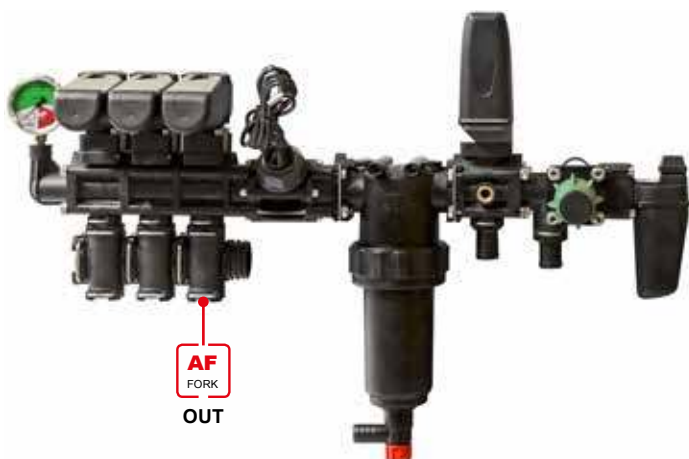

REDUCING PRESSURE RESIDUAL IN THE BOOMS

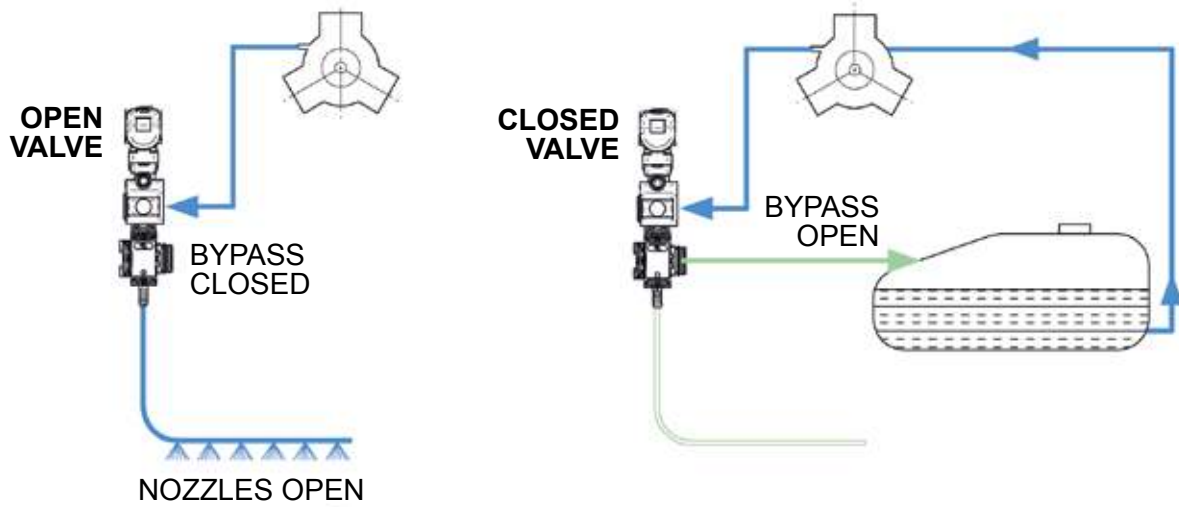

RECIRCULATION IN TANK

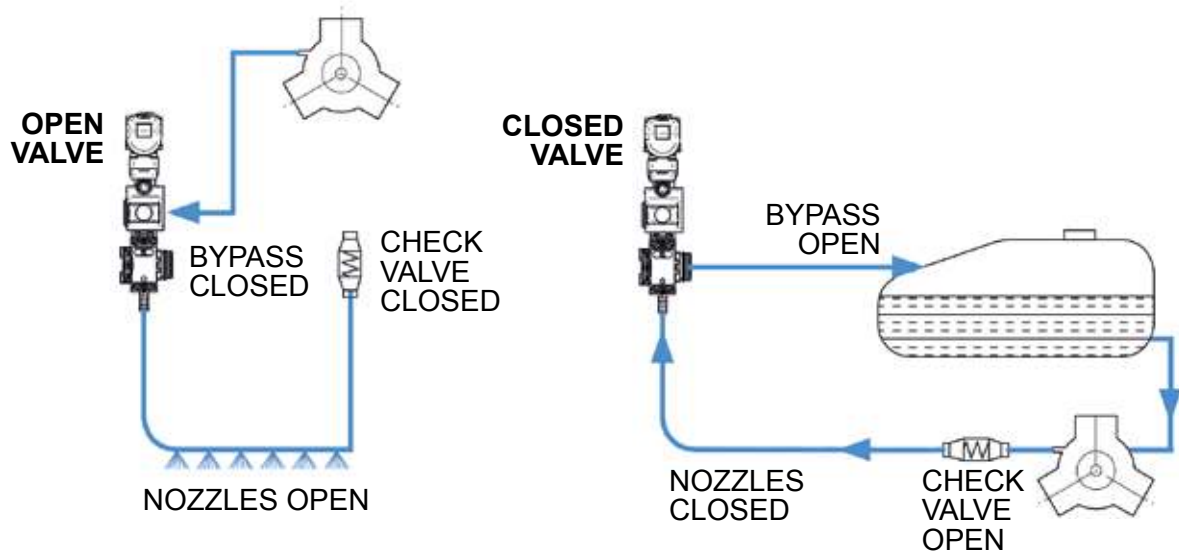

CLEANING PIPES AT END OF CYCLE

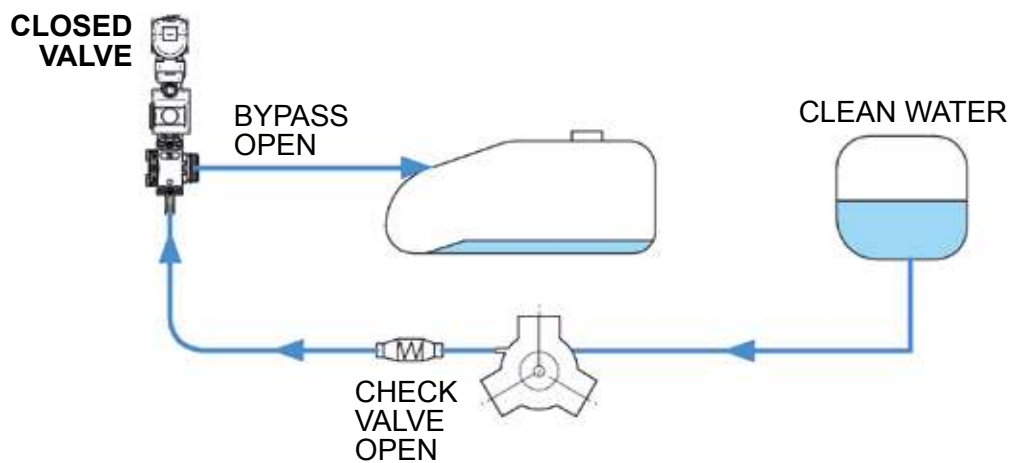



ADAPTERS → NRG & NRG PLUS

Flange di accoppiamento per valvole elettriche NRG e NRG PLUS.

Adapters for electric valves NRG and NRG PLUS.

Соединительные фланцы для электрических клапанов NRG и NRG PLUS.

ADAPTERS >> FEMALE

Flangia filetto maschio
Male threaded adapter
Фланец с наружн.резьбой

Part No.	Ø	Pack
F00102000	G 3/4	1
F00102001	G 1	1
F00102002	G 1 1/4	1
F00102024	G 1 1/2	1
F00102014	G 3/4	1 *
NEW F00102042	G 1	1 *

Flangia filetto femmina
Female threaded adapter
Фланец с внутр.резьбой

Part No.	Ø	Pack
F00102003	G 3/4	1
F00102004	G 1	1
F00102019	3/4 NPT	1
F00102020	1 NPT	1

Flangia chiusa
Closed adapter
Закрытый фланец

Part No.	Pack
F00102005	1
F00102015	1 *

Flangia AF femmina
Female AF adapter
Фланец BC "мама"

Part No.	Type	Pack
F00102028	AF5	1

Flangia AF maschio
Male AF adapter
Фланец BC "папа"

Part No.	Type	Pack
NEW 8392098	AF5	1

Adattatore NRG/DIS
Adapter NRG/DIS
Адаптер NRG/DIS

Part No.	Pack
F00102018	1

Flangia porta manometro
Pressure gauge adapter
Фланец держ.манометра

Part No.	Ø	Pack
F00102030	G 1/4	1
F00102016	G 1/4	1 *
F00102025	1/4 NPT	1

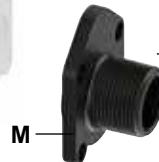
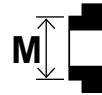

ADAPTERS >> MALE

Flangia filetto maschio
Male threaded adapter
Фланец с наружн.резьбой

Part No.	Ø	Pack
F00102007	G 3/4	1
F00102008	G 1	1
F00102009	G 1 1/4	1
F00102023	G 1 1/2	1
F00102017	G 3/4	1 *
NEW F00102043	G 1	1 *

Flangia filetto femmina
Female threaded adapter
Фланец с внутр.резьбой

Part No.	Ø	Pack
F00102010	G 3/4	1
F00102011	G 1	1
F00102021	3/4 NPT	1
F00102022	1 NPT	1

Flangia chiusa
Closed adapter
Закрытый фланец

Part No.	Pack
F00102012	1

Flangia AF maschio
Male AF adapter
Фланец BC "папа"

Part No.	Type	Pack
NEW 8392099	AF5	1

Flangia AF maschio
Male AF adapter
Фланец BC "папа"

Part No.	Type	Pack
F00102034	AF5	1

Kit adattatore VGE-VGM-VGME-NRG
Adapter kit VGE-VGM-VGME-NRG
Компл.адаптера VGE-VGM-VGME-NRG

Part No.	Pack
8392062	1

Fino ad esaurimento
Selling out
до окончания складских запасов

* Ottone / Brass / Латунь



ASSEMBLING KIT → NRG & NRG PLUS

Kit di assemblaggio valvole in acciaio inox, serie NRG ed NRG PLUS.

Stainless steel assembling kit for valves, NRG and NRG PLUS serie.

Сборочный комплект клапанов из нержавеющей стали серии NRG и NRG PLUS.

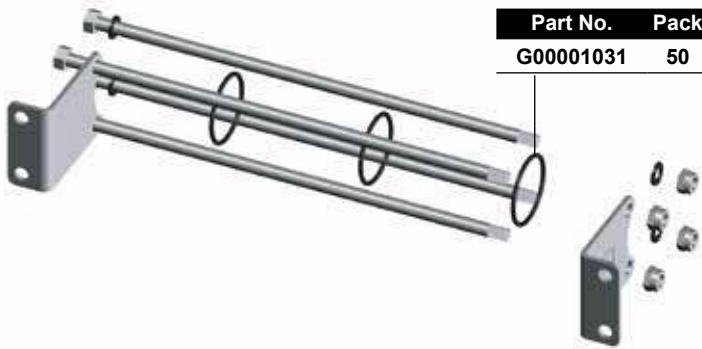

Part No.	Pack
G00001031	50

Part No.	Part No.	Valves	L	Pack
INOX	ZINC COATING		mm	
8392034	8392075	1	85	1
8392035	8392076	2	140	1
8392036	8392077	3	200	1
8392037	8392078	4	256	1
8392038	8392079	5	315	1
8392039	8392080	6	370	1
8392040	/	7	430	1
8392041	/	8	485	1
8392042	/	9	545	1



MANIFOLDS KIT → NRG

Kit collettori compensatori per valvole serie NRG

Kit of compensating manifolds for NRG valves.

Комплект компенсационных коллекторов для клапанов серии NRG.

NRG

Forchetta
Fork
Вилка

Part No.	Pack
F00000011	1

G1" M

G1 M outlet

Part No.	Pack
K99900057	1

Intermediate

Part No.	Pack
K99900056	1

Closed

Part No.	Pack
K99900055	1

Portagomma
Hosetail
Штуцер

Part No.	Ø mm	Pack
R00000064	13	1
R00000065	16	1

Part No.	Pack
T00000017	1

Tappo
Plug
Заглушка

Collettori con valvola di bilanciamento.
Manifolds with balancing valve.

Коллекторы с балансировочным клапаном.



G1" M

Part No.	Valves	Pack
8392043	2	1
8392044	3	1
8392045	4	1
8392046	5	1
8392047	6	1
8392048	7	1



MANIFOLDS KIT → NRG

Kit collettori compensatori per valvole serie NRG

Kit of compensating manifolds for NRG valves.

Комплект компенсационных коллекторов для клапанов серии NRG.

NRG

Part No. Pack
G00001023 1

Closed

Part No.	Ø mm	Pack
8392050	10	1
8392059	12,5	1
8392049	14	1
8392051	16	1

Intermediate

Part No.	Ø mm	Pack
8392053	10	1
8392060	12,5	1
8392052	14	1
8392054	16	1

G1 M outlet

Part No.	Ø mm	Pack
8392056	10	1
8392061	12,5	1
8392055	14	1
8392057	16	1



MANIFOLDS KIT → NRG PLUS

Flange di completamento per collettori compensatori valvole serie NRG PLUS.

Accessory discs for NRG PLUS valves' compensating manifolds.

Дополнительные фланцы для компенсационных коллекторов клапанов серии NRG PLUS.

NRG PLUS

Part No.	Type	Pack
C00600022	G1½ M	1

Part No.	Type	Pack
T00000037	closed M	1

Part No.	Pack
G00001074	50

Part No.	Type	Pack
T00000046	closed F	1

Part No.	Type	Pack
C00600020	G1½ M	1

Part No.	Pack
F00000018	1

Rapid Fan



Flussometro ispezionabile con turbina.

- Per applicazioni agricole, industriali, nautiche, mobili, ecc..
- Di facile installazione e manutenzione;
- Affidabile;
- Turbina in materiale anticorrosione Acciaio Inox alta resistenza;
- Cuscinetti in zaffiro;
- Completo di flange d'accoppiamento NRG Geoline 1" ;
- Corpo in poliarilammide rinforzato con fibra di vetro;
- Alimentazione 9-32 V DC;
- Spia di alimentazione a LED.

Uscita: NPN Open Collector (Max 200 mA)

Precisione: minore o Uguale 1% FSO

Impulsi (Tipici): 700 Imp/Litro

Inspectable flowmeter with turbine.

- For agricultural, industrial, nautical, mobile, etc. applications.
- Easy to install and maintain;
- Reliable;
- Turbine made of corrosion proof High resistance Stainless Steel;
- Sapphire bearings;
- Complete with NRG Geoline 1" coupling flanges;
- Glass fibre reinforced polyarylamide body;
- 9-32 V DC power supply;
- LED power light.

Outlet: NPN Open Collector (Max 200 mA)

Precision: less or equal to 1% FSO

Impulses (Typical): 700 imp/l

Разбирающийся расходомер с турбиной.

- Может использоваться в сельском хозяйстве, промышленности, в портах и тп.;
- Легко устанавливается и обслуживается;
- Надежная конструкция
- Турбина выполнена в антикоррозийной стали AISI серии 4;
- Подшипники из сапфира;
- Подшипники из сапфира;
- Снабжен фланцами для подключения к NRG Geoline 1";
- Корпус выполнен из полиариламида, усиленного стекловолокном;
- Питание 9-32 V DC;
- Сигнальная лампочка подключения к сети

Выход: NPN Open collector (макс. 200 mA)

Точность замера: меньше или равно 1% FSO

Импульсы (обычно): 700/л

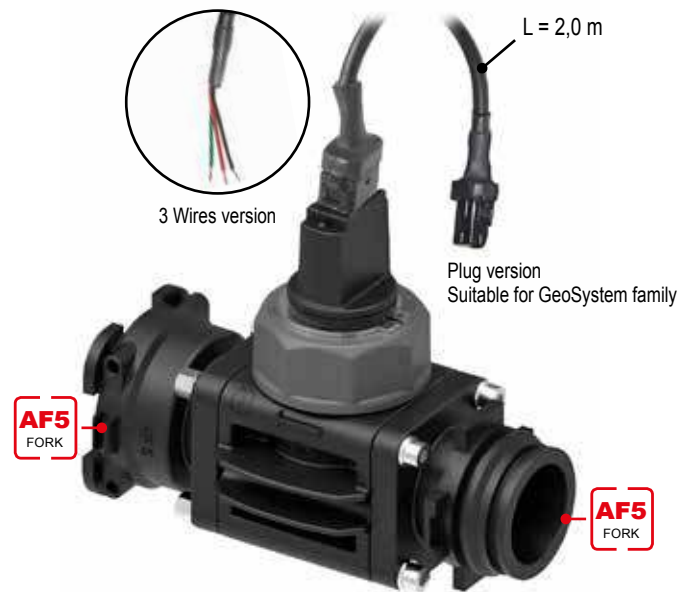

	Part No.	I/I'	bar	ERR. % FSO	°C	V dc	Pack
	3 Wires 8404012	10÷200	50	≤ 1	0 → +70	9 - 32 ~0,6	1
	Plug 8404026	10÷200	50	≤ 1	0 → +70	9 - 32 ~0,6	1
NEW	3 Wires 8404039	2,5÷25	50	≤ 1	0 → +70	9 - 32 ~0,6	1
NEW	Plug 8404041	2,5÷25	50	≤ 1	0 → +70	9 - 32 ~0,6	1

	Part No.	Type	I/I'	bar	ERR. % FSO	°C	V dc	Pack
	3 Wires 8404027	F - M	10÷100	20	≤ 1	0 → +70	9 - 32 ~0,6	1
	Plug 8404028	F - M	10÷100	20	≤ 1	0 → +70	9 - 32 ~0,6	1
	3 Wires 8404034	F - F	10÷100	20	≤ 1	0 → +70	9 - 32 ~0,6	1
	Plug 8404035	F - F	10÷100	20	≤ 1	0 → +70	9 - 32 ~0,6	1

PRESSURE DROP

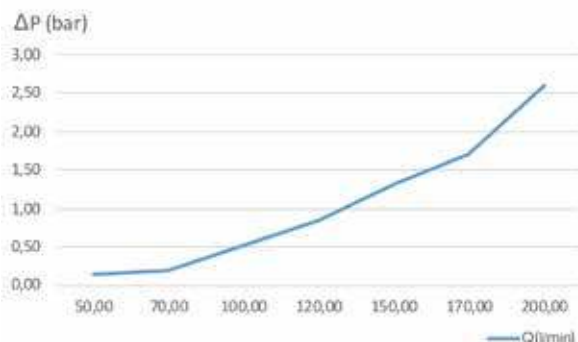

PRESSURE DROP

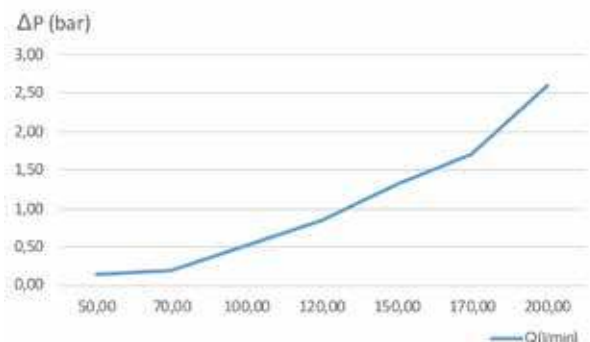

Rapid Fan M100/ M200

NEW



Flussometro ispezionabile con turbina.

- Per applicazioni agricole, industriali, nautiche, mobili, ecc..
- Di facile installazione e manutenzione;
- Affidabile;
- Turbina in materiale anticorrosione Acciaio Inox alta resistenza;
- Cuscinetti in zaffiro;
- Corpo in poliarilammide rinforzato con fibra di vetro;
- Alimentazione 9-32 V DC;
- Spia di alimentazione a LED.

Uscita: NPN Open Collector (Max 200 mA)
Precisione: minore o Uguale 1% FSO
Impulsi (Tipici): 700 Imp/Litro

Inspectable flowmeter with turbine.

- For agricultural, industrial, nautical, mobile, etc. applications.
- Easy to install and maintain;
- Reliable;
- Turbine made of corrosion proof High resistance Stainless Steel;
- Sapphire bearings;
- Glass fibre reinforced polyarylamide body;
- 9-32 V DC power supply;
- LED power light.

Outlet: NPN Open Collector (Max 200 mA)
Precision: less or equal to 1% FSO
Impulses (Typical): 700 imp/l

Разбирающийся расходомер с турбиной.

- Может использоваться в сельском хозяйстве, промышленности, в портах и тп;
- Легко устанавливается и обслуживается;
- Надежная конструкция
- Турбина выполнена в антикоррозийной стали AISI серии 4;
- Подшипники из сапфира;
- Корпус выполнен из полиариламида, усиленного стекловолокном;
- Питание 9-32 V DC;
- Сигнальная лампочка подключения к сети

Выход: NPN Open collector (макс. 200 мА)
Точность замера: меньше или равно 1% FSO
Импульсы (обычно): 700/л

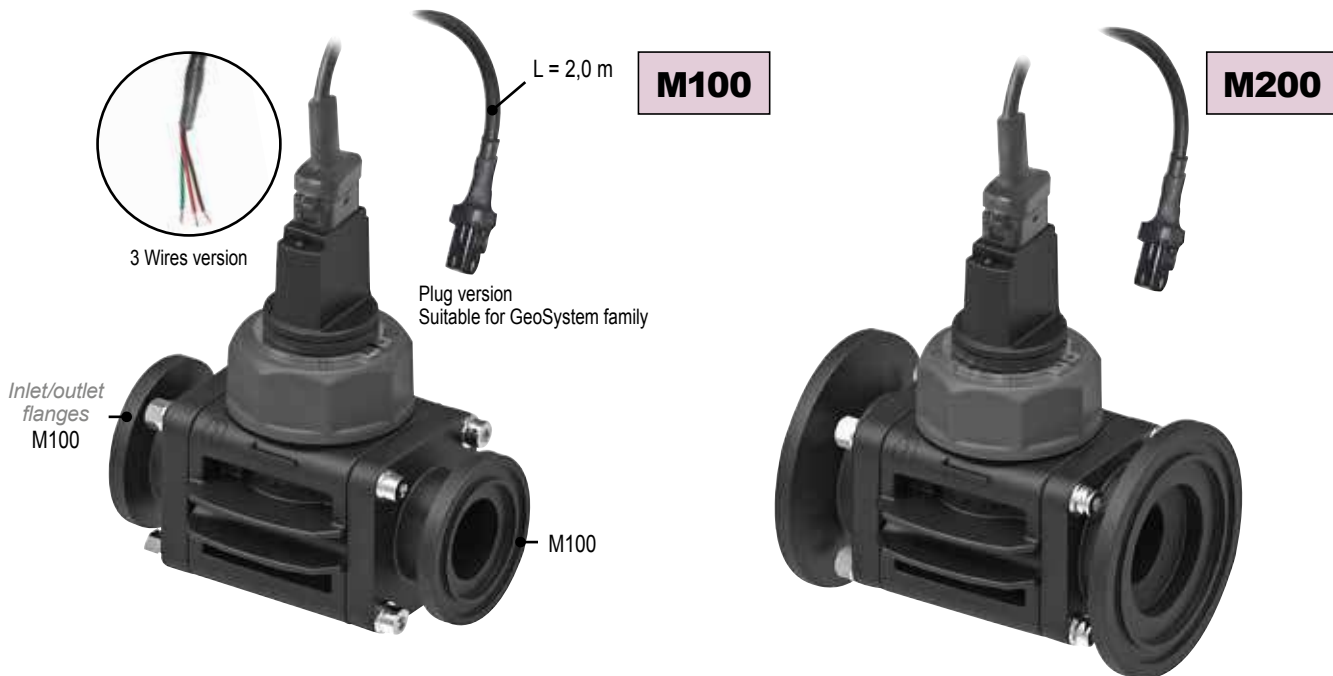

Part No.	Type	1/1"	bar	% FSO	ERR.	°C	V dc	Pack
3 Wires 8404049	M100	10÷200	20	≤ 1	0 → +70	9 - 32	~0,6	1
Plug 8404043								
3 Wires 8404050	M200	10÷200	20	≤ 1	0 → +70	9 - 32	~0,6	1
Plug 8404044								

PRESSURE DROP

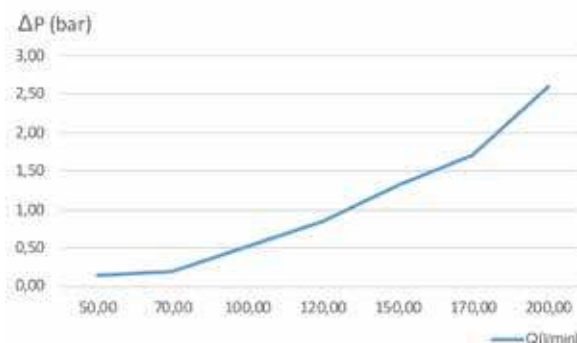

Rapid Fan



Use



ACCESSORIES & SPARE PARTS

Part No.	Description	Pack	
S02000015	Kit Sensor + Flow meter adapter cable L= 2,0 m PLUG-WIRES	1	
S02000016	Kit Sensor + Flow meter adapter cable L= 2,0 m PLUG-PLUG	1	
C00902104	Flow meter adapter cable L= 2,0 m PLUG-WIRES	1	
C00902105	Connecting cable for L= 2,0 m PLUG+PLUG	1	
C00902135	Flow meter adapter cable L= 0,5 m PLUG-SUPER SEAL	1	
S02000014	Flowmeter sensor assembly	Output 1	
8404017	Rapid Fan turbine 1"	1	
NEW 8404040	Rapid Fan turbine 1" 2,5+25 l/min	1	

DIMENSIONS NRG

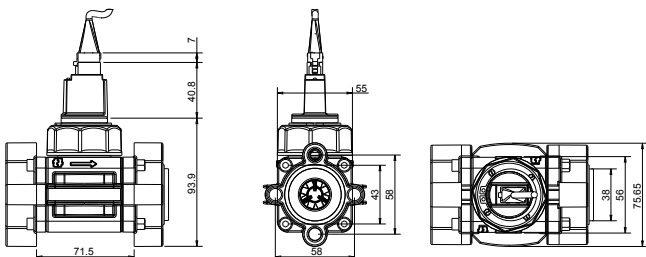

DIMENSIONS AF

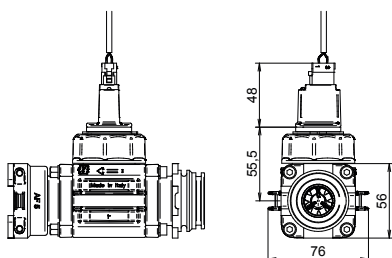

DIMENSIONS M100/ M200

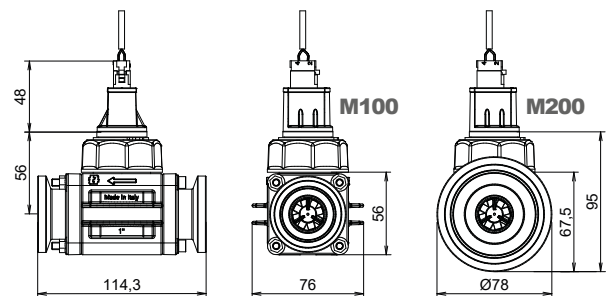

Electromagnetic Flowmeter



Flussometro elettromagnetico

- Per applicazioni agricole, industriali, nautiche, mobili, ecc..
- Di facile installazione e manutenzione;
- Affidabile;
- Completo di flange d'accoppiamento NRG Geoline 1";
- Corpo in poliarilammide rinforzato con fibra di vetro;
- Alimentazione 9-32 V DC;

Uscita: NPN Open Collector (Max 200 mA)
Precisione: minore o Uguale 1% FSO

Electromagnetic Flowmeter

- For agricultural, industrial, nautical, mobile, etc. applications.
- Easy to install and maintain;
- Reliable;
- Complete with NRG Geoline 1" coupling flanges;
- Glass fibre reinforced polyarylamide body;
- 9-32 V DC power supply;

Outlet: NPN Open Collector (Max 200 mA)
Precision: less or equal to 1% FSO

Электромагнитный расходомер

- Может использоваться в сельском хозяйстве, промышленности, в портах и тп;
- Легко устанавливается и обслуживается;
- Надежная конструкция;
- Снабжен фланцами для подключения к NRG Geoline 1";
- корпус выполнен из полиариламида (ПАА), усиленного стекловолокном;
- Питание 9-32 V DC;
- Сигнальная лампочка подключения к сети;

Выход: NPN Open collector (макс. 200 mA)
Точность замера: меньше и равна 1% FSO



Body
Glass fibre reinforced polyarylamide

Inlet/outlet flanges
NRG 1"

Part No.	I/1'	bar	% FSO	°C	V dc	Pack
8404023	3÷60	50	≤ 1	0 → +70	9-32	~0,6 1
8404024	5÷100	50	≤ 1	0 → +70	9-32	~0,6 1
8404025	10÷200	50	≤ 1	0 → +70	9-32	~0,6 1

Use



PRESSURE DROP

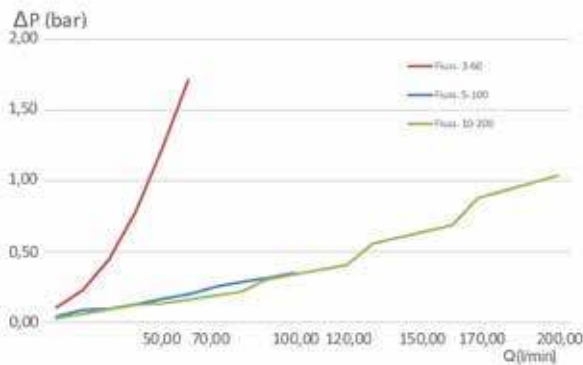

Obbligatorio ordinare separatamente.
Compulsory: to be ordered separately.
Обязательно заказывать отдельно.

Part No.	Description	Pack
C00902104	Flow meter adapter cable L= 2,0 m PLUG-WIRES	1
C00902105	Connecting cable for L = 2,0 m PLUG+PLUG	1
C00902135	Flow meter adapter cable L= 0,5 m PLUG-SUPER SEAL	1

DIMENSIONS

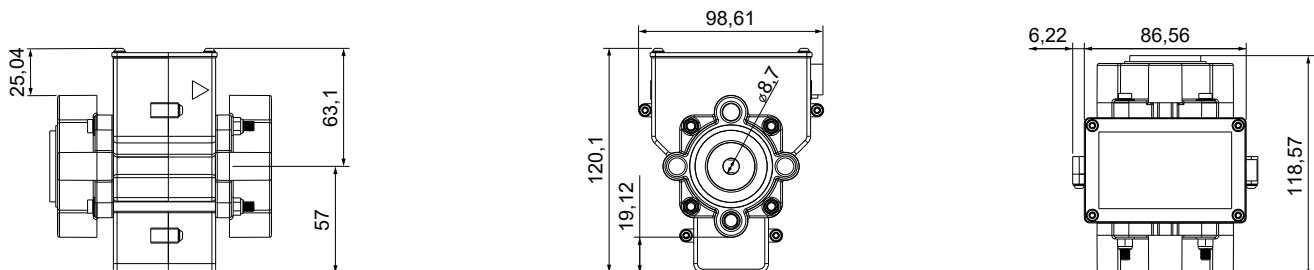

Electromagnetic Flowmeter

AF
FORK



Flussometro elettromagnetico

- Per applicazioni agricole, industriali, nautiche, mobili, ecc..
- Di facile installazione e manutenzione;
- Affidabile;
- Corpo in poliarilammide rinforzato con fibra di vetro;
- Alimentazione 9-32 V DC;
- Uscita: NPN Open Collector (Max 200 mA)
- Precisione: minore o Uguale 1% FSO.
- Attacco a forchetta.

Electromagnetic Flowmeter

- For agricultural, industrial, nautical, mobile, etc. applications.
- Easy to install and maintain;
- Reliable;
- Glass fibre reinforced polyarylamide body;
- 9-32 V DC power supply;
- Outlet: NPN Open Collector (Max 200 mA)
- Precision: less or equal to 1% FSO.
- Fork couplings.

Электромагнитный расходомер

- Может использоваться в сельском хозяйстве, промышленности, в портах и тп.;
- Легко устанавливается и обслуживается;
- Надежная конструкция;
- корпус выполнен из полиариламида (ПАА), усиленного стекловолокном;
- Питание 9-32 V DC;
- Сигнальная лампочка подключения к сети;
- Выход: NPN Open collector (макс. 200 mA)
- Точность замера: меньше и равна 1% FSO.
- Вилочное соединение.



Part No.	Type	I/I'	bar	% FSO	°C	V dc	Pack
A 8404030	F - M	5+100	20	≤ 1	0 → +70	9 - 32	~0,6 1
A 8404031	F - M	10+200	20	≤ 1	0 → +70	9 - 32	~0,6 1
B 8404032	F - F	5+100	20	≤ 1	0 → +70	9 - 32	~0,6 1
B 8404033	F - F	10+200	20	≤ 1	0 → +70	9 - 32	~0,6 1

Use



Obbligatorio ordinare separatamente.
Compulsory: to be ordered separately.
Обязательно заказывать отдельно.

Part No.	Description	Pack
C00902104	Flow meter adapter cable L= 2,0 m PLUG-WIRES	1
C00902105	Connecting cable for L = 2,0 m PLUG+PLUG	1
C00902135	Flow meter adapter cable L= 0,5 m PLUG-SUPER SEAL	1

PRESSURE DROP

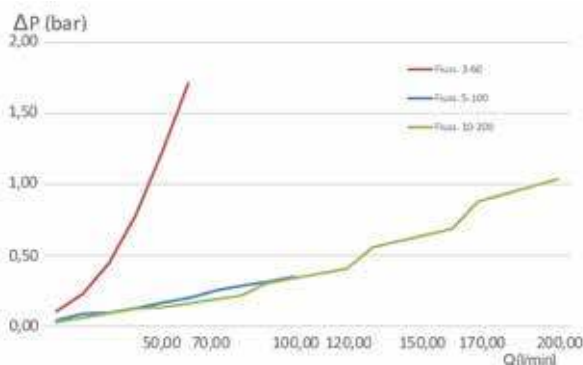

DIMENSIONS

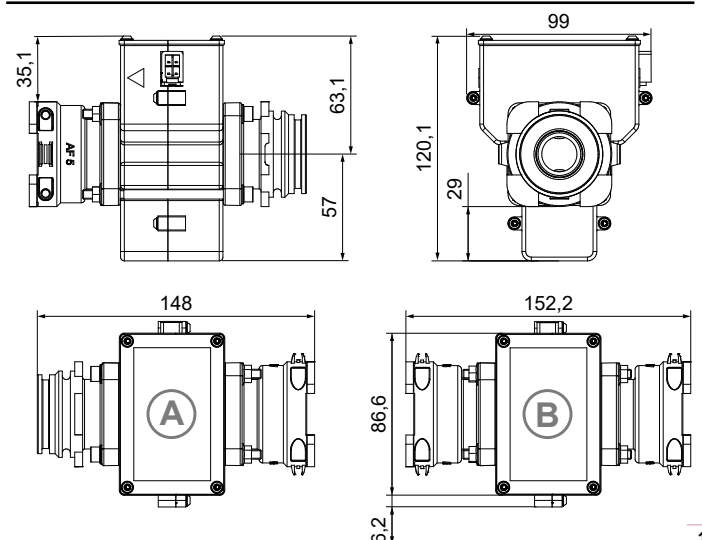

Electromagnetic Flowmeter



Flussometro elettromagnetico

- Per applicazioni agricole, industriali, nautiche, mobili, ecc..
- Di facile installazione e manutenzione;
- Affidabile;
- Completo di flange d'accoppiamento NRG Geoline 1";
- Corpo in poliarilammide rinforzato con fibra di vetro;
- Alimentazione 9-32 V DC;
- Uscita: NPN Open Collector (Max 200 mA)
- Precisione: minore o Uguale 1% FSO

Electromagnetic Flowmeter

- For agricultural, industrial, nautical, mobile, etc. applications.
- Easy to install and maintain;
- Reliable;
- Complete with NRG Geoline 1" coupling flanges;
- Glass fibre reinforced polyarylamide body;
- 9-32 V DC power supply;
- Outlet: NPN Open Collector (Max 200 mA)
- Precision: less or equal to 1% FSO

Электромагнитный расходомер

- Может использоваться в сельском хозяйстве, промышленности, в портах и тп.;
- Легко устанавливается и обслуживается;
- Надежная конструкция;
- Снабжен фланцами для подключения к NRG Geoline 1";
- корпус выполнен из полиариламида (ПАА), усиленного стекловолокном;
- Питание 9-32 V DC;
- Сигнальная лампочка подключения к сети;
- Выход: NPN Open collector (макс. 200 mA)
- Точность замера: меньше и равна 1% FSO



Part No.	Type	I/I'	bar	% FSO	°C	V dc	Pack
A 8404045	M100	5÷100	20	≤ 1	0 → +70	9 - 32	~0,6
A 8404046		10÷200		≤ 1			
B 8404047	M200	5÷100	20	≤ 1	0 → +70	9 - 32	~0,6
B 8404048		10÷200		≤ 1			

Use



Obbligatorio ordinare separatamente.
Compulsory: to be ordered separately.
Обязательно заказывать отдельно.

Part No.	Description	Pack
C00902104	Flow meter adapter cable L= 2,0 m PLUG-WIRES	1
C00902105	Connecting cable for L= 2,0 m PLUG+PLUG	1
C00902135	Flow meter adapter cable L= 0,5 m PLUG-SUPER SEAL	1

PRESSURE DROP

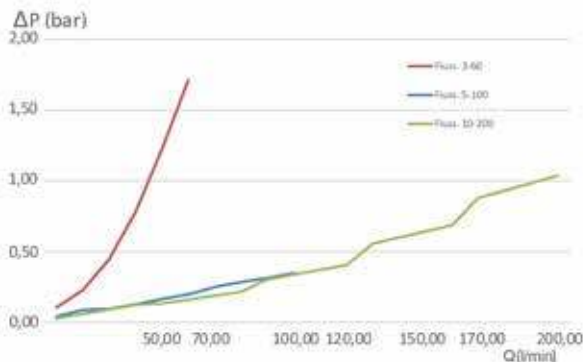

DIMENSIONS

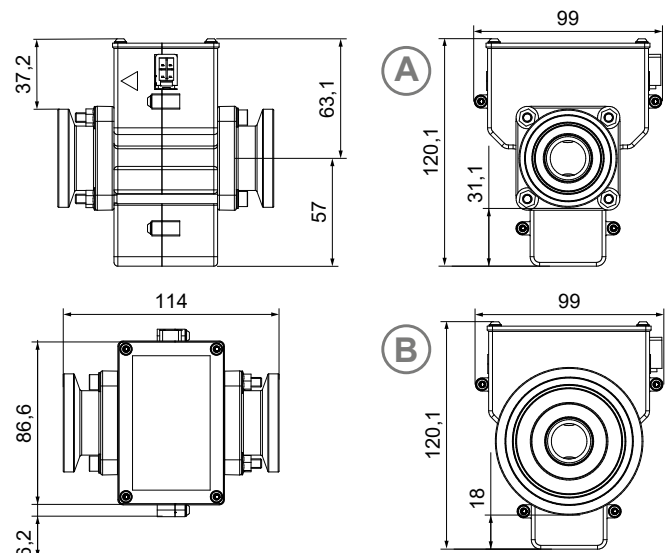

Filtri in linea flangiati con spurgo per gruppi di comando manuali ed elettrici serie NRG.

Flanged line filters with drain valve for manual and electric control units.

Фланцевые линейные фильтры со спускным клапаном для ручных и электрических блоков управления серии NRG.

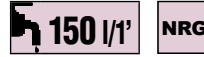
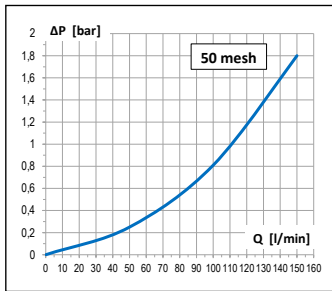

Part No.	bar	l/1'	Type	Screen	Screen Material	Pack
8124004	20	150	Standard	50 mesh	INOX	1
8124005				80 mesh		
8125010	20	150	Self Cleaning	50 mesh		
8125011				80 mesh		

SPARE PARTS

Part No.	Screen Mesh	Screen Material	Pack
C00100004	32	INOX	1
C00100005	50		
C00100006	80		
C00100007	100		

Part No.	Gasket	Material
G00001024	O-Ring	EPDM

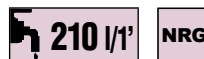
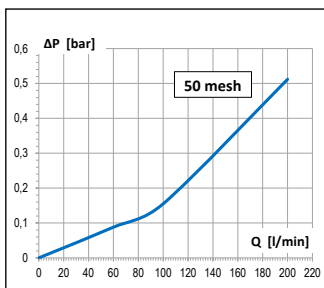

Part No.	bar	l/1'	Type	Screen	Screen Material	Pack
8124006	15	210	Standard	50 mesh	INOX	1
8124007				80 mesh		
8125012	15	210	Self Cleaning	50 mesh		
8125013				80 mesh		

SPARE PARTS

Part No.	Screen Mesh	Screen Material	Pack
C00100032	32	INOX	1
C00100033	50		
C00100034	80		
C00100035	100		

Part No.	Gasket	Material
G00001046	O-Ring	EPDM

Gruppo per atomizzatore 2 vie a pressione costante, composto da 2 elettrovalvole a solenoide e valvola manuale di regolazione pressione.

Uscita: G1/2" - Ingresso: 3/4"

Ideale per applicazioni su atomizzatori e gruppi irroranti.

Da completare con i relativi cavi elettrici e scatola di comando.

2-way Control unit for orchard sprayers at constant pressure with 2 solenoid valves and pressure relief manual valve.

1/2" BSP outlet and 3/4" BSP inlet

Perfect for applications on orchard sprayers and spraying machines.

To complete please order connecting cables and control panel.

2-ходовой блок управления для распылителей при постоянном давлении, укомплектованный 2 электромагнитными клапанами и ручным регулировочным клапаном давления.

Выход : 1/2" BSP – Вход: 3/4" BSP

Предусмотрен для применения на распылителях и разбрызгивателях. Подлежит комплектации соответствующей электропроводкой блоком управления.



Part No.	Valves	l/1'	bar	°C	V dc	Pack
8378021	2	150	40	60	12	1

DIMENSIONS

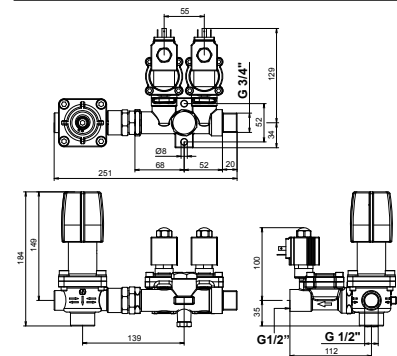

OPTIONALS



Pag. 346 Pag. 131 Pag. 45

Gruppo per atomizzatore 4 vie a pressione costante, composto da 4 elettrovalvole a solenoide e valvola manuale di regolazione pressione.

Uscita: G1/2" - Ingresso: 3/4"

Ideale per applicazioni su atomizzatori e gruppi irroranti.

Da completare con i relativi cavi elettrici e scatola di comando.

4-way Control unit for orchard sprayers at constant pressure with 4 solenoid valves and pressure relief manual valve.

1/2" BSP outlet and 3/4" BSP inlet

Perfect for applications on orchard sprayers and spraying machines.

To complete please order connecting cables and control panel.

4-ходовой блок управления для распылителей при постоянном давлении, укомплектованный 4 электромагнитными клапанами и ручным регулировочным клапаном давления.

Выход : 1/2" BSP – Вход: 3/4" BSP

Предусмотрен для применения на распылителях и разбрызгивателях. Подлежит комплектации соответствующей электропроводкой и блоком управления.

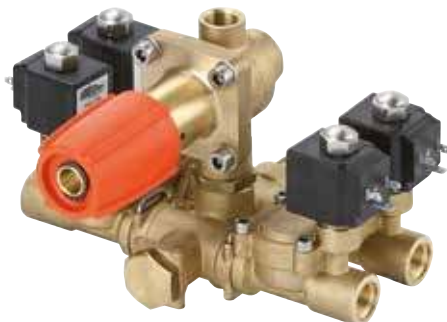

Part No.	Valves	l/1'	bar	°C	V dc	Pack
8378022	4	150	40	60	12	1

DIMENSIONS

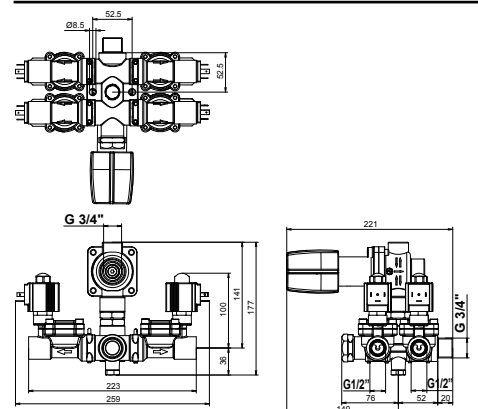

OPTIONALS



Pag. 346 Pag. 131 Pag. 45

Gruppo per atomizzatore 2 vie a pressione costante, composto da 2 elettrovalvole a solenoide, valvola manuale di regolazione pressione e filtro. Uscita: G1/2 - Ingresso: G3/4
Ideale per applicazioni su atomizzatori e gruppi irroranti.
Da completare con i relativi cavi elettrici e scatola di comando.

2-way Control unit for orchard sprayers at constant pressure with 2 solenoid valves, pressure relief manual valve and filter.
1/2" BSP outlet and 3/4" BSP inlet
Perfect for applications on orchard sprayers and spraying machines.
To complete please order connecting cables and control panel.

2-ходовой блок управления для распылителей при постоянном давлении, укомплектованный 2 электромагнитными клапанами, ручным регулировочным клапаном давления и фильтром. Выход: 1/2" BSP - Вход: 3/4" BSP
Предусмотрен для применения на распылителях и разбрызгивателях. Подлежит комплектации соответствующей электропроводкой и блоком управления.



Part No.	Valves	l/1'	bar	°C	V dc	Pack
8378023	2	150	40	60	12	1

DIMENSIONS

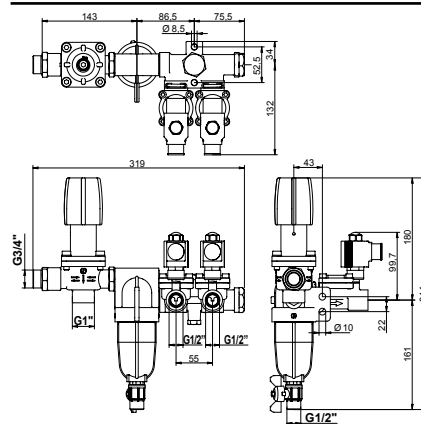

OPTIONALS



Pag. 346 Pag. 131 Pag. 45

Elettrovalvola a solenoide MY18

Ideale per applicazioni su atomizzatori e gruppi irroranti.
Ideale per assemblaggi modulari.
Da completare con i relativi cavi elettrici e scatola di comando.

Electric Solenoid Valve MY18

Perfect for applications on orchard sprayers
Ideal for modular assembling
To complete please order connecting cables and control panel.

Электромагнитный клапан MY18

Предусмотрен для использования на распылителях и обрызгивателях.
Идеален для модульной сборки.
Подлежит комплектации соответствующей электропроводкой и блоком управления.



Part No.	l/1'	bar	°C	V dc	Pack
8388027	80	20	60	12	1
8388030	80	40	60	12	1

Ingresso: attacco rapido - Uscita: G1/2

Inlet: QUICK fitting - Outlet: 1/2" BSP

Вход: соединение QUICK - Выход: 1/2" BSP

OPTIONALS



Pag. 131



DIMENSIONS

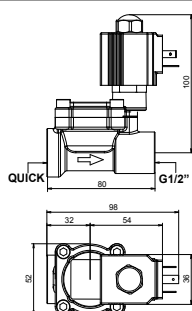

Part No.	l/1'	bar	°C	V dc	Pack
8388028	80	20	60	12	1
8388031	80	40	60	12	1

Ingresso / Uscita: G1/2

1/2" BSP Inlet and Outlet

Вход / Выход: 1/2" BSP



DIMENSIONS

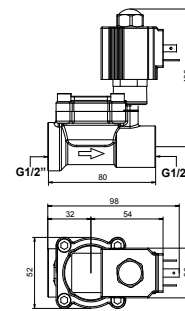

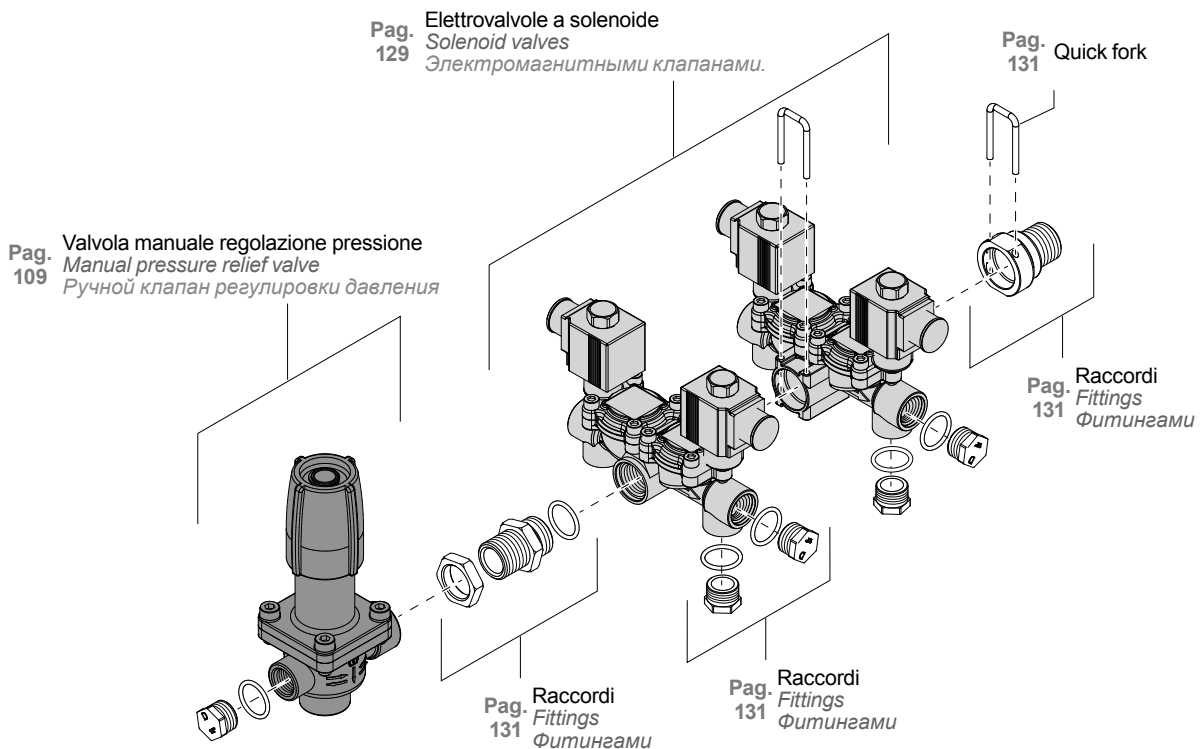
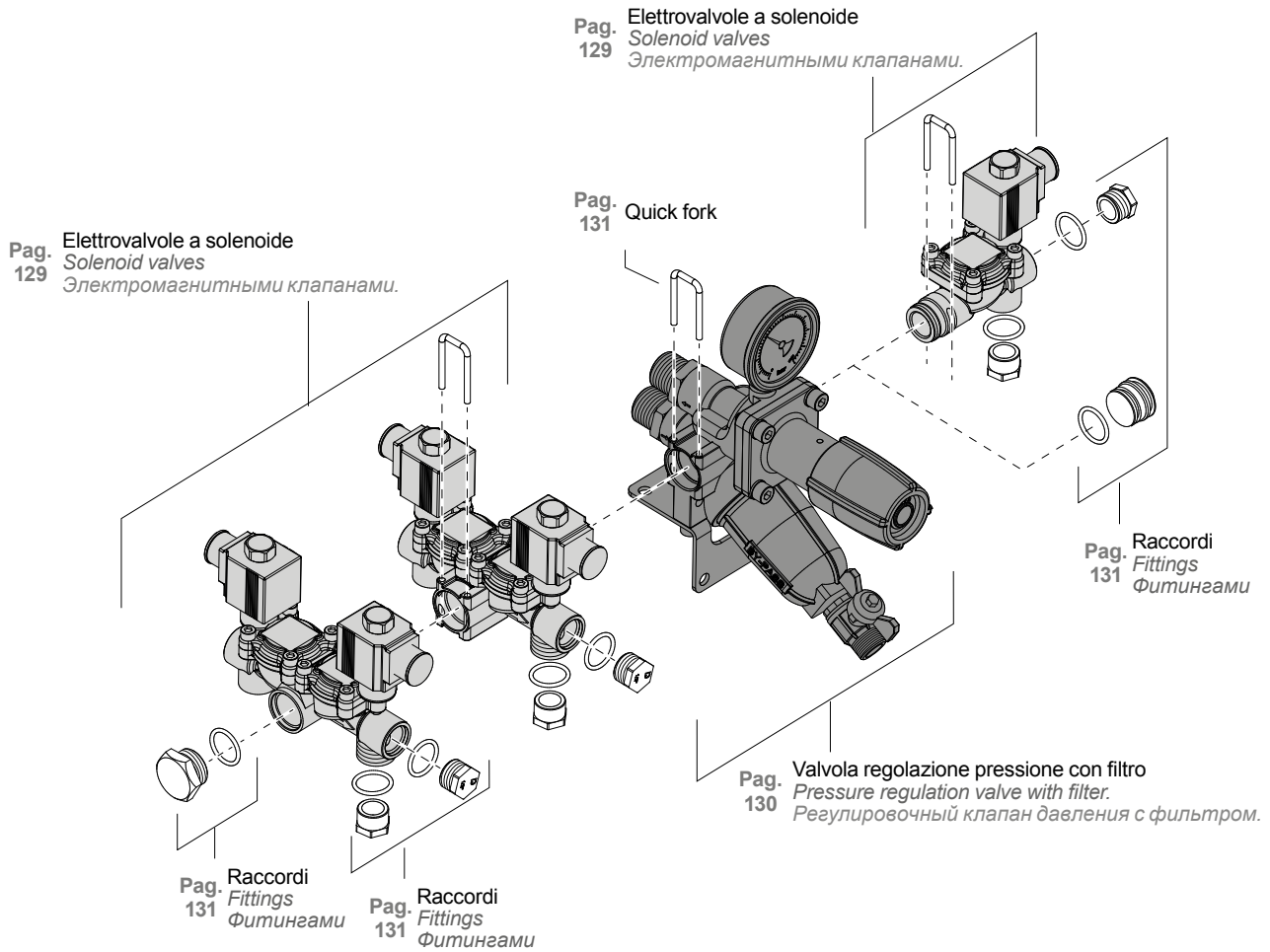

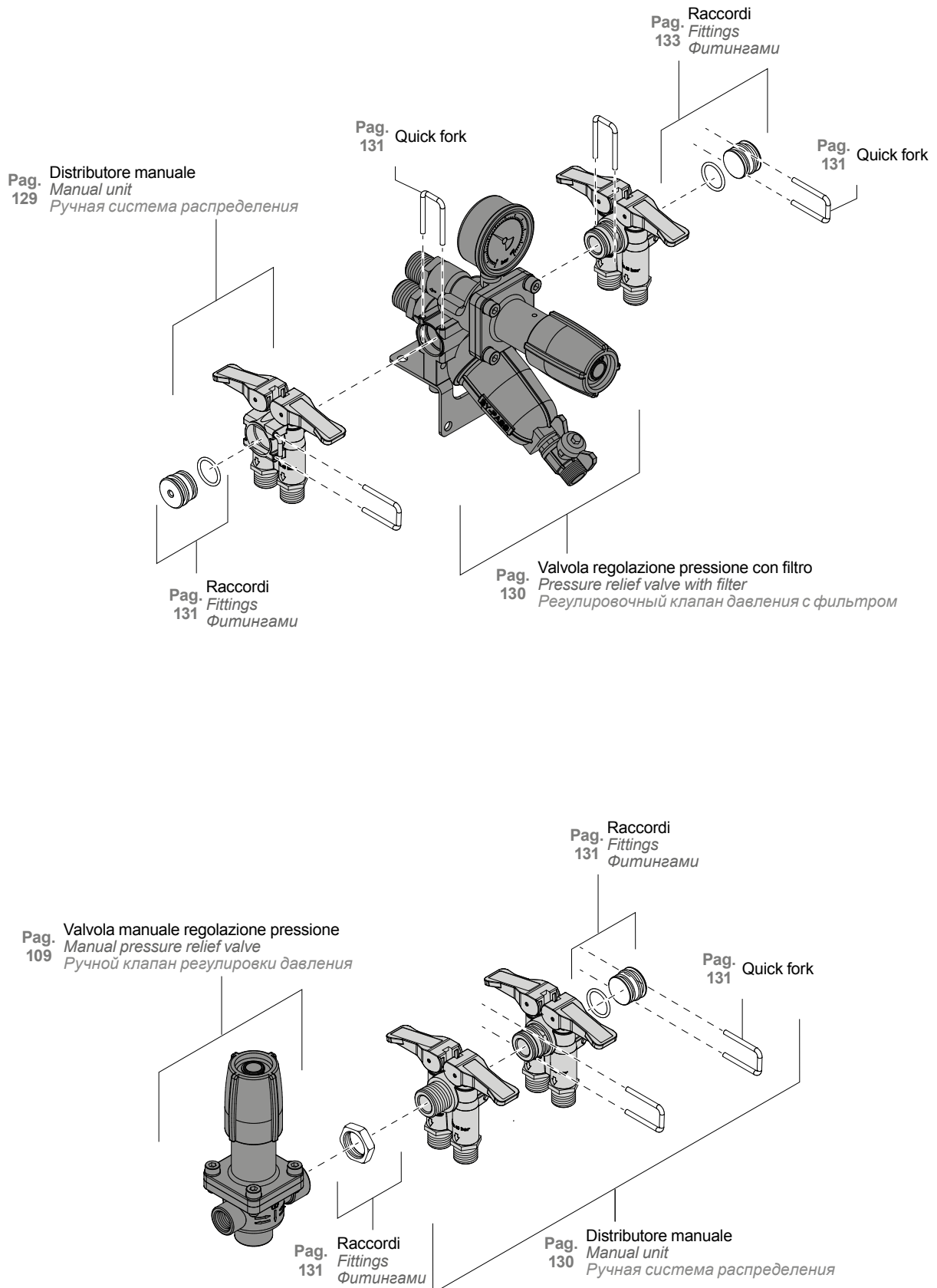

Gruppo per atomizzatore 2 vie a pressione costante, composto da 2 elettrovalvole a solenoide e valvola manuale di regolazione pressione. Ideale per applicazioni su atomizzatori e gruppi irroranti.
Da completare con i relativi cavi elettrici e scatola di comando.

2-way Control unit for orchard sprayers at constant pressure with 2 solenoid valves and pressure relief manual valve.
Perfect for applications on orchard sprayers and spraying machines.
To complete please order connecting cables and control panel.

2-ходовой блок управления для распылителей при постоянном давлении, укомплектованный 2 электромагнитными клапанами и ручным регулировочным клапаном давления.
Предусмотрен для применения на распылителях и разбрызгивателях. Подлежит комплектации соответствующей электропроводкой блоком управления.

NEW

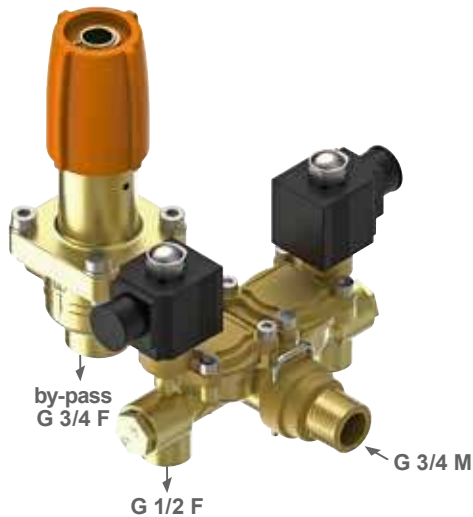

Part No.	Valves	l/1'	bar	°C	V dc	Pack
8378065	2	150	40	60	12	1

DIMENSIONS

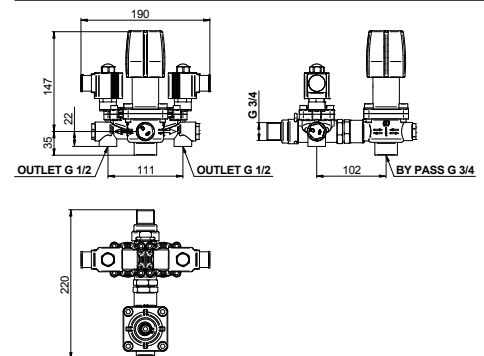

OPTIONALS



Pag. 346 Pag. 131 Pag. 45

Gruppo per atomizzatore 4 vie a pressione costante, composto da 4 elettrovalvole a solenoide e valvola manuale di regolazione pressione. Ideale per applicazioni su atomizzatori e gruppi irroranti.
Da completare con i relativi cavi elettrici e scatola di comando.

4-way Control unit for orchard sprayers at constant pressure with 4 solenoid valves and pressure relief manual valve.
Perfect for applications on orchard sprayers and spraying machines.
To complete please order connecting cables and control panel.

4-ходовой блок управления для распылителей при постоянном давлении, укомплектованный 4 электромагнитными клапанами и ручным регулировочным клапаном давления.
Предусмотрен для применения на распылителях и разбрызгивателях. Подлежит комплектации соответствующей электропроводкой и блоком управления.

NEW

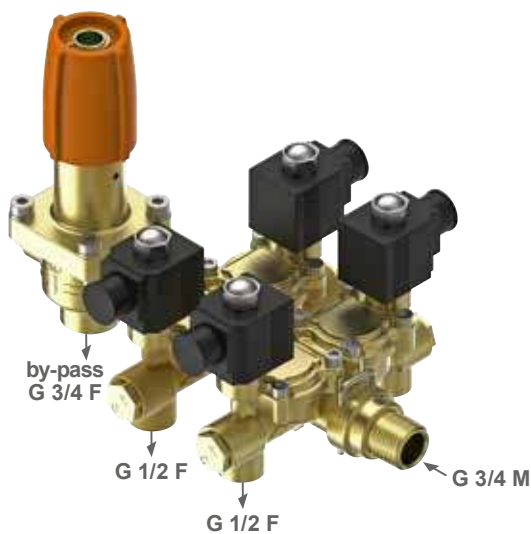

Part No.	Valves	l/1'	bar	°C	V dc	Pack
8378066	4	150	40	60	12	1

DIMENSIONS

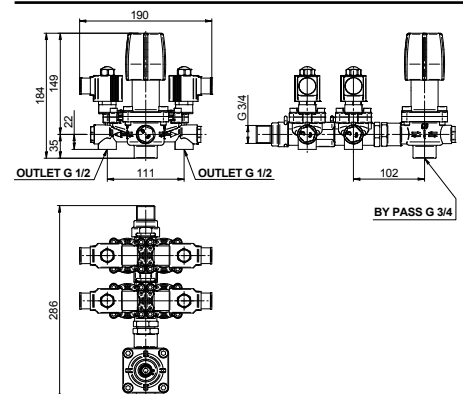

OPTIONALS



Pag. 346 Pag. 131 Pag. 45

Gruppo per atomizzatore 2 vie a pressione costante, composto da 2 elettrovalvole a solenoide, valvola manuale di regolazione pressione e filtro. Ideale per applicazioni su atomizzatori e gruppi irroranti.
Da completare con i relativi cavi elettrici e scatola di comando.

2-way Control unit for orchard sprayers at constant pressure with 2 solenoid valves, pressure relief manual valve, and filter.
Perfect for applications on orchard sprayers and spraying machines.
To complete please order connecting cables and control panel.

Блок для 2-ходового распылителя постоянного давления, состоящий из 2 электромагнитных клапанов, регулировочного клапана давления с ручным управлением и фильтра. Превосходно подходит для применения на распылителях и опрыскивателях. Подлежит комплектации соответствующей электропроводкой и блоком управления.

NEW

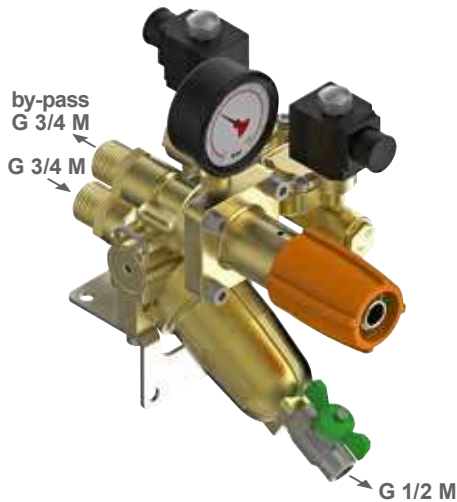

Part No.	Valves	l/1'	bar	°C	V dc	Mesh	Pack
8378067	2	150	40	60	12	40	1

DIMENSIONS

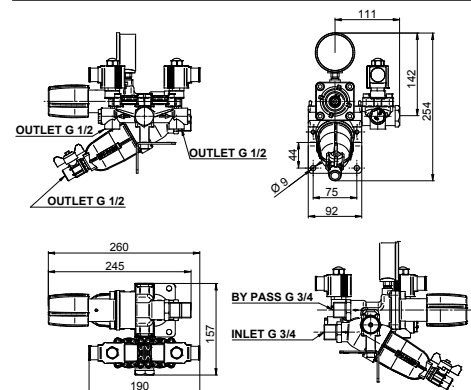

OPTIONALS



Pag. 131 Pag. 45

Gruppo per atomizzatore 4 vie a pressione costante, composto da 4 elettrovalvole a solenoide, valvola manuale di regolazione pressione e filtro. Ideale per applicazioni su atomizzatori e gruppi irroranti.
Da completare con i relativi cavi elettrici e scatola di comando.

4-way Control unit for orchard sprayers at constant pressure with 4 solenoid valves, pressure relief manual valve, and filter.
Perfect for applications on orchard sprayers and spraying machines.
To complete please order connecting cables and control panel.

Блок для 4-ходового распылителя постоянного давления, состоящий из 4 электромагнитных клапанов, регулировочного клапана давления с ручным управлением и фильтра. Превосходно подходит для применения на распылителях и опрыскивателях. Подлежит комплектации соответствующей электропроводкой и блоком управления.

NEW

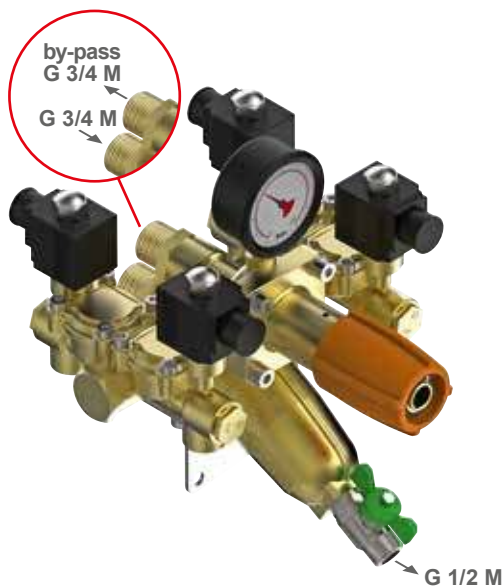

Part No.	Valves	l/1'	bar	°C	V dc	Mesh	Pack
8378068	4	150	40	60	12	40	1

DIMENSIONS

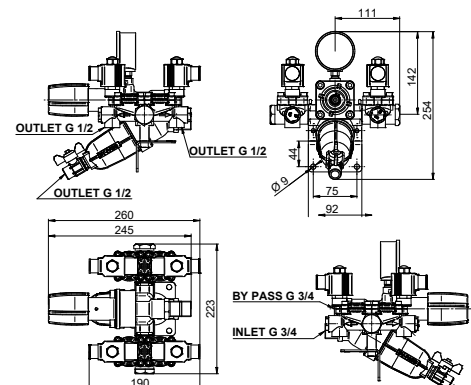

OPTIONALS



Pag. 131 Pag. 45

Gruppo per atomizzatore 2 vie a pressione costante, composto da 2 rubinetti manuali, valvola manuale di regolazione pressione e filtro.
Ideale per applicazioni su atomizzatori e gruppi irroranti.
Da completare con i relativi cavi elettrici e scatola di comando.

2-way Control unit for orchard sprayers at constant pressure with 2 modular valves, pressure relief manual valve, and filter.
Perfect for applications on orchard sprayers and spraying machines.
To complete please order connecting cables and control panel.

Блок для 2-ходового распылителя постоянного давления, состоящий из 2 кранов с ручным управлением, регулировочного клапана давления с ручным управлением и фильтра. Превосходно подходит для применения на распылителях и опрыскивателях. Подлежит комплектации соответствующей электропроводкой и блоком управления.

NEW

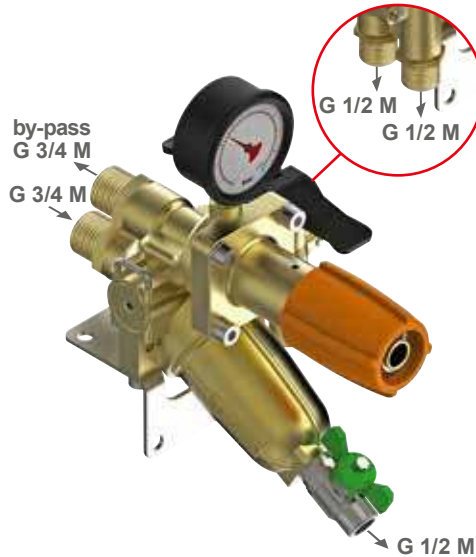

Part No.	Valves	l/1'	bar	°C	V dc	Mesh	Pack
8378069	2	150	40	60	12	40	1

DIMENSIONS

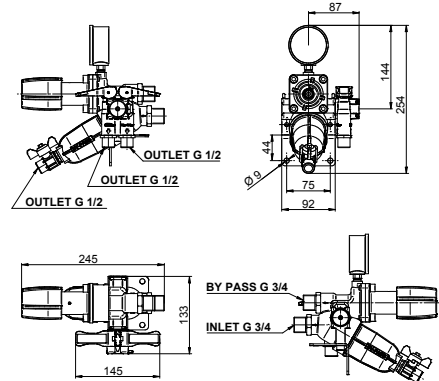

Gruppo per atomizzatore 2 vie a pressione costante, composto da 4 rubinetti manuali, valvola manuale di regolazione pressione e filtro.
Ideale per applicazioni su atomizzatori e gruppi irroranti.
Da completare con i relativi cavi elettrici e scatola di comando.

2-way Control unit for orchard sprayers at constant pressure with 4 modular valves, pressure relief manual valve, and filter.
Perfect for applications on orchard sprayers and spraying machines.
To complete please order connecting cables and control panel.

Блок для 2-ходового распылителя постоянного давления, состоящий из 4 кранов с ручным управлением, регулировочного клапана давления с ручным управлением и фильтра. Превосходно подходит для применения на распылителях и опрыскивателях. Подлежит комплектации соответствующей электропроводкой и блоком управления.

NEW

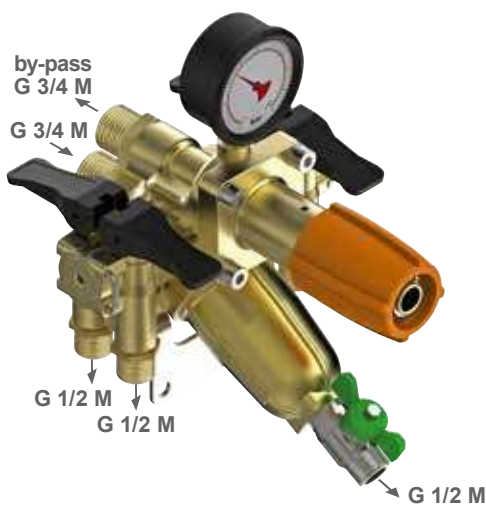

Part No.	Valves	l/1'	bar	°C	V dc	Mesh	Pack
8378070	4	150	40	60	12	40	1

DIMENSIONS

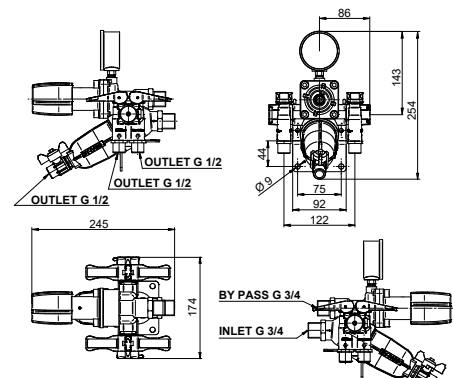

Elettrovalvola a solenoide MY20

Ideale per applicazioni su atomizzatori e gruppi irroranti.
Ideale per assemblaggi modulari.
Da completare con i relativi cavi elettrici e scatola di comando.

Electric Solenoid Valve MY20

Perfect for applications on orchard sprayers
Ideal for modular assembling
To complete please order connecting cables and control panel.

Электромагнитный клапан MY20

Предусмотрен для использования на распылителях и обрызгивателях.
Идеален для модульной сборки.
Подлежит комплектации соответствующей электропроводкой и блоком управления.



Part No.	1/1'	bar	°C	V dc	Pack
8388036	80	40	60	12	1



Part No.	1/1'	bar	°C	V dc	Pack
8388037	80	40	60	12	1

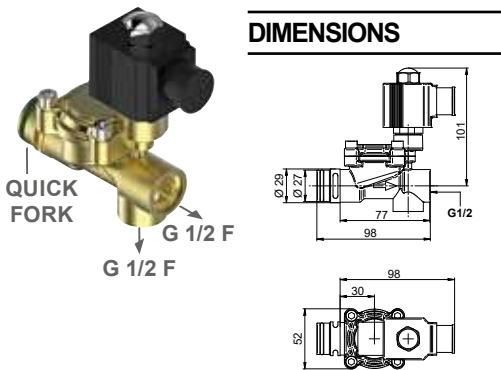

OPTIONALS



Pag. 131 Pag. 45

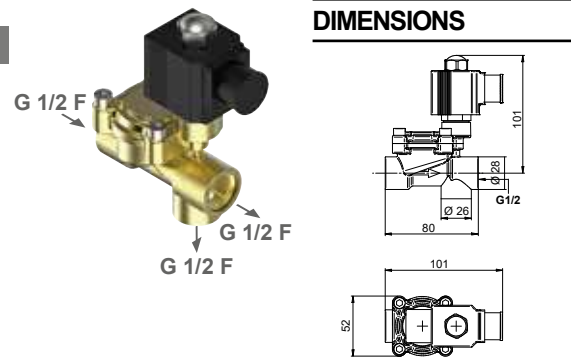

Gruppo per atomizzatore 2 vie a pressione costante, composto da 2 elettrovalvole a solenoide.
Ideale per applicazioni su atomizzatori e gruppi irroranti.
Da completare con i relativi cavi elettrici e scatola di comando.

2-way Control unit for orchard sprayers at constant pressure with 2 solenoid valves.
Perfect for applications on orchard sprayers and spraying machines.
To complete please order connecting cables and control panel.

2-ходовой блок управления для распылителей при постоянном давлении, укомплектованный 2 электромагнитными клапанами.
Предусмотрен для применения на распылителях и разбрызгивателях. Подлежит комплектации соответствующей электропроводкой блоком управления.



Part No.	1/1'	bar	°C	V dc	Pack
8372089	80	40	60	12	1



Part No.	1/1'	bar	°C	V dc	Pack
8372090	80	40	60	12	1

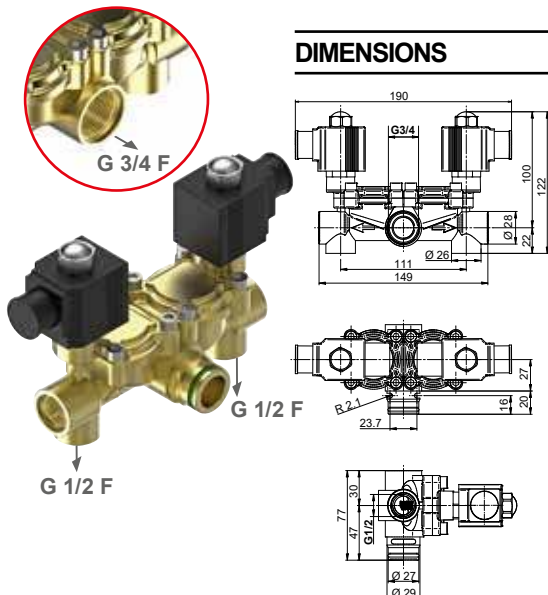

OPTIONALS



Pag. 131 Pag. 45

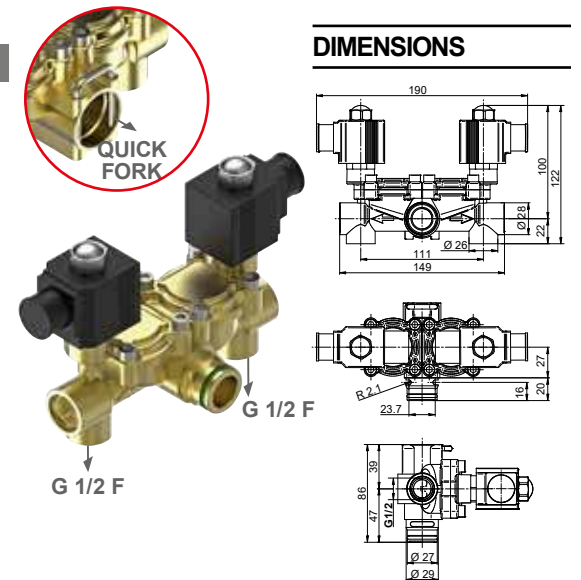

Valvola regolazione pressione con filtro.

Pressure regulation valve with filter.

Регулировочный клапан давления с фильтром.

NEW

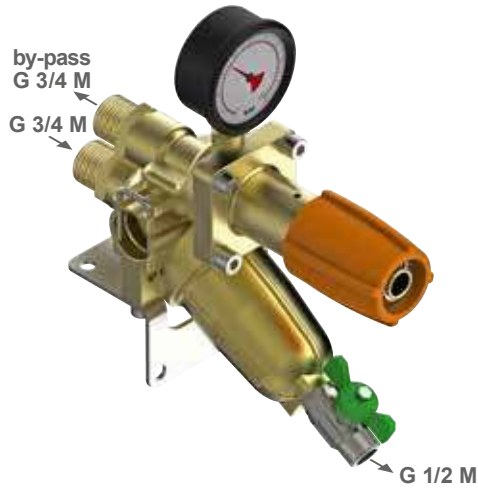

Part No.	1/1'	bar	°C	Mesh Pack
8384057	150	40	60	40 1

DIMENSIONS

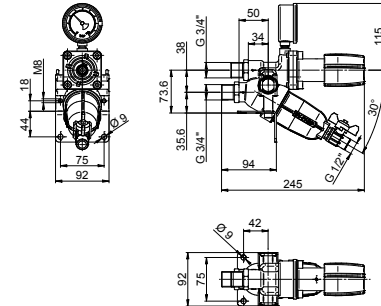

Distributore manuale con rubinetti modulari.

Manual distributor with modular taps.

Ручная система распределения с модульными кранами.

NEW

Part No. Pack
T00000039 1

Tappo
Plug
Заглушка

Part No. Pack
G00001059 1

O-ring
O-ring
кольцевого уплотнения



	Part No.	Valves	1/1'	bar	°C	Pack
A	8372086	2	80	40	60	1
B	8372088	2	80	40	60	1

DIMENSIONS

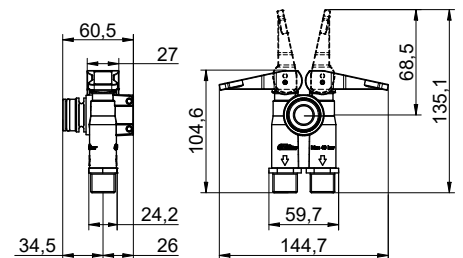

LEVER DOUBLE MOUNTING SYSTEM

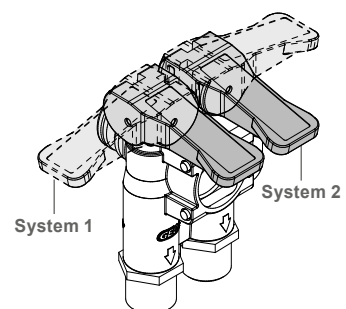

Accessori per elettrovalvole a solenoide

Solenoid valves accessories

Комплектующие для электромагнитных клапанов

	Part No.	Type	Pack
1	8304058	G 3/4	10
2	8304057	G 3/4 M- G 3/4 M	25
3	8304000	G 3/4 M	10
4	R00000106	G 1/2 F - QUICK	1
5	T00000031	G 1/4 M	1



	Part No.	Material	Pack
7	F00000016	INOX	1
8	G00001059	VITON	50
9	G00001192	VITON	50
10	G00002025	VITON	50



NEW

NEW

NEW

NEW

	Part No.	Type	Pack
11	T00000039	Quick	1
12	8304107	1/2	25
13	8304106	3/4	1



	Part No.	Valves	Pack
6	C00601006	2	1
6	C00601007	4	1



INSTALLATION

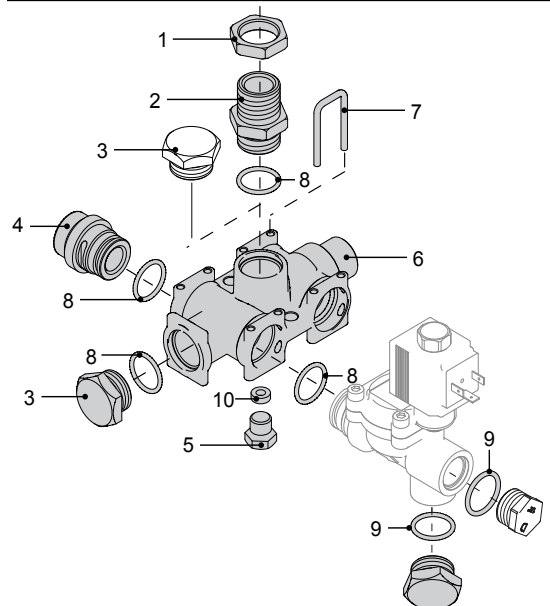

Cavo di alimentazione per valvole elettriche a solenoide, completo di guarnizione e vite di fissaggio.
Dotato di led segnalazione valvola aperta.

Power supply cable for solenoid valves with fittings and screw.
Open valve led indicator included.

Силовой кабель для электромагнитных клапанов, в комплектации прокладкой и крепежным винтом.
Оснащен сигнальным светодиодом открытого клапана.



Part No.	L mm	°C	V dc	Pack
C00900021	1500	60	12	1

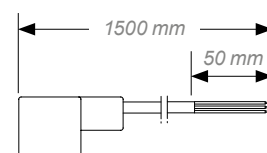

Tracciafile GFM 25

- Compressore a membrana con motore elettrico.
- Cofano compressore in ABS rosso.
- Serbatoio in polietilene da 24 L ad alta resistenza. Tappo serbatoio completo di regolatore di flusso con all'interno valvola di sicurezza in plastica tarata fissa a 0,7 bar e valvola di non ritorno, a membrana ad alta sensibilità.
- Tubazione aria-liquido con tubi in polietilene 6x4 ricoperti di morbida guaina.
- Spruzzatori verticali da 150 mm per l'erogazione della schiuma, con supporti regolabili e diffusori per aumentare la dimensione e durata della schiuma sul terreno.
- Scatola con interruttore di comando elettrico, lampade di indicazione lato funzionamento e fusibile di protezione.
- Cavo alimentazione da 2 m con presa e spina, cavo collegamento al compressore da 5 m.
- Utilizzabile con radiocomandi serie GeoCrop.

Foam marker GFM 25

- Diaphragm compressor with electric motor
- Compressor casing in red ABS.
- High resistant polyethylene tank of 24 lt with flow regulator.
- Pre-setted safety valve (0.7 bar) and diaphragm check valve.
- Air & Liquid polyethylene pipings of 6x4 mm with soft rubber protection hose.
- Vertical foam spreaders of 150 mm length with adjustable supports and diffusers to increase foam volume and life on the ground.
- Box with electrical control switch, warning lamp on the running side and protection fuse.
- 2m feeding cable with outlet and plug, 5m connecting cable to the compressor.
- Can be used with the GeoCrop series of remote controls.

Пенный маркер GFM 25

- Мембранный компрессор с электродвигателем.
- Капот компрессора из красного ABS.
- Высокопрочная емкость из полиэтилена 24 литра.
- Пробка емкости с регулятором потока с внутренним предохранительным пластмассовым клапаном, с регулировкой на 0.7 бар и обратным мембранным высокочувствительным клапаном.
- Труба воздуха-жидкости с полиэтиленовыми трубками 6x4 с мягким покрытием.
- Вертикальные распылители длиной 150 мм для подачи пены, с регулируемыми опорами и диффузорами для увеличения размера и времени нахождения пены на земле.
- Коробка с электрическим выключателем, индикаторными лампочками рабочей стороны и защитным предохранителем.
- Силовой кабель 2 м с розеткой и вилкой, соединительный кабель с компрессором 5 м.
- Может использоваться с пультами радиоуправления серии GeoCrop.

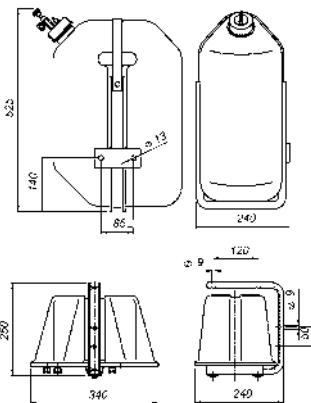

Part No.	°C	V dc	Pack
8394014	60	12	1

Kit per il collegamento di un tracciafile ad un computer o ad una scatola idraulica di comando.

Wiring kit to connect a foam marker to a computer or to a hydraulic control box.

Комплект для подсоединения пенного маркера к компьютеру или гидравлическому блоку управления.



Part No.	°C	V dc	Type	Pack
A 8394007	60	12	standard	1
B 8394016	60	12	GeoSystem	1

B Adatto per / Suitable to / Предусмотрен для
GS 260 CS GS 250 CS GS 200
GS 260 CS H GS 250 CS H

Schiumogeno

È un prodotto di buona qualità, inerte, con maggiore permanenza sul terreno e buona visibilità.

Foaming agent

Good quality inert foaming agent. It generates a long standing and highly visible foam.

Пенообразующее средство

Качественный инертный продукт с хорошей продолжительностью пребывания на поверхности земли и хорошей видимостью.



200 kg



25 kg



5 kg

Part No.	Color	Contents	Type	Pack
8394008	PINK	kg 5 - Lb 11,1	standard	4
8394009	BROWN	kg 5 - Lb 11,1	long lasting	4
8394003	PINK	kg 25 - Lb 55,5	standard	1
8394004	BROWN	kg 200 - Lb 440	long lasting	1

GEOPUMP



GEARS



Pompa elettrica 12V ad ingranaggi

Gears electric pump 12V

Шестеренный электронасос 12В



Gears - BRASS



Part No.	l/1'	bar	m	°C	Kg	V dc	A	Pack
8411018	12,0	3,5	3	60	2,68	12	10,0	1

DIMENSIONS

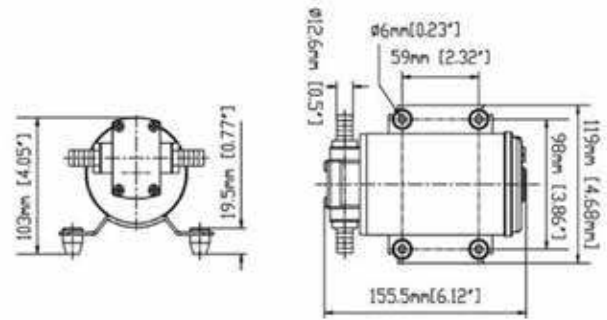



OPTIONALS



Pag. 42

Composizione del kit Kit composed of / Комплектация

Description	Q.ty
GeoPump 	1
Hosetail  Ø 14,5 mm G 3/8	2

GEOPUMP



Pompa elettrica 12V / 24V

Caratteristiche

ingresso/uscita attacco rapido
Per uso intermittente (30 min. on - 30 min. off).
4 pompanti a membrana, auto adescante, può funzionare a secco
Valvole in Viton® , membrana in TPE.

Applicazioni

- Agricole
- Irrorazione
- Industriali
- Automotive (caravan)
- Marine

Electric Pump 12V / 24V

Features

Quick lock ports.
For intermittent periodic duty cycles (30 min. on - 30 min. off).
4 chamber diaphragm pump, self priming, it runs dry.
Viton® valves, TPE diaphragm.

Applications

- Agriculture
- Spraying
- Industry
- Automotive
- Marine

Электронасос 12В / 24В

Характеристики

Вход/выход с быстросоединяющим соединением.
Для прерывистого использования (30 мин. ON - 30 мин. OFF).
4-камерный диафрагменный самозаливной насос, может работать в сухом режиме.
Клапаны из Viton®, диафрагма из TPE.

Применение

- Сельское хозяйство
- Орошение
- Промышленность
- Автомобилестроение
- Морские сферы применения



Quick lock ports



Part No.	l/1'	bar	m	°C	Kg	V dc	A	Pack
8411021	17,0	2,8	1,8	60	2,3	12	15,0	1
8411022	17,0	2,8	1,8	60	2,3	24	6,0	1

DIMENSIONS

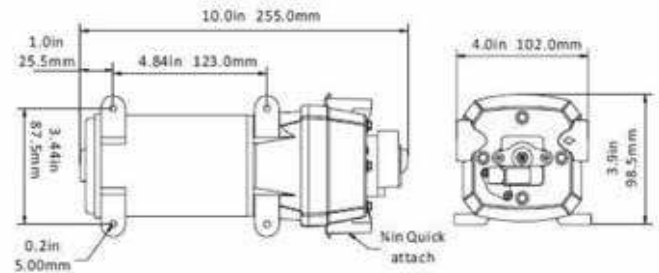

OPTIONALS



Pag. 42

Composizione del kit

Kit composed of / Комплектация

Description		Q.ty
GeoPump		1
Inlet filter	40 Mesh Ø 12,5 mm	1
90° hoesetail	Ø 12,5 mm	2
Hoesetail	Ø 12,5 mm	2

GEOPUMP



Pompa elettrica 12V / 24V

Caratteristiche

ingresso/uscita attacco rapido
Per uso intermittente (30 min. on - 30 min. off).
4 pompanti a membrana, auto adescante, può funzionare a secco
Valvole in Viton® , membrana in TPE.

Applicazioni

- Agricole
- Irrorazione
- Industriali
- Automotive (caravan)
- Marine

Electric Pump 12V / 24V

Features

Quick lock ports.
For intermittent periodic duty cycles (30 min. on - 30 min. off).
4 chamber diaphragm pump, self priming, it runs dry.
Viton® valves, TPE diaphragm.

Applications

- Agriculture
- Spraying
- Industry
- Automotive
- Marine

Электронасос 12В / 24В

Характеристики

Вход/выход с быстродействующим соединением.
Для прерывистого использования (30 мин. ON - 30 мин. OFF).
4-камерный диафрагменный самозаливной насос, может работать в сухом режиме.
Клапаны из Viton®, диафрагма из TPE.

Применение

- Сельское хозяйство
- Орошение
- Промышленность
- Автомобилестроение
- Морские сферы применения



Quick lock ports



Part No.	l/1'	bar	m	°C	Kg	V dc	A	Pack
8411019	12,5	2,4	1,8	60	1,8	12	8,0	1
8411020	12,5	2,4	1,8	60	1,8	24	4,0	1

DIMENSIONS

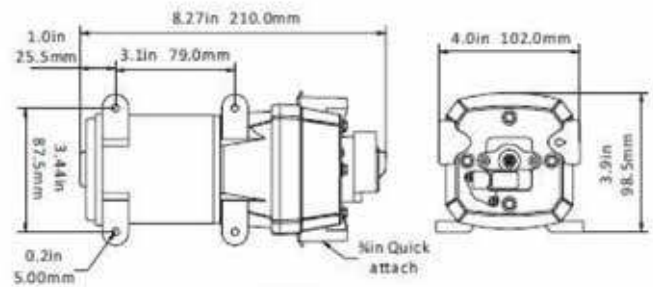

OPTIONALS



Pag. 42

Composizione del kit

Kit composed of / Комплектация

Description		Q.ty
GeoPump		1
Inlet filter	40 Mesh Ø 12,5 mm	1
90° hosetail	Ø 12,5 mm	2
Hosetail	Ø 12,5 mm	2

GEOPUMP



Pompa elettrica 12V

Caratteristiche

ingresso/uscita 3/8" NPT.

3 pompanti a membrana, auto adescante, può funzionare a secco

Valvole in Viton® , membrana in TPE.

Per uso continuo.

Applicazioni

- Agricole
- Irrorazione
- Industriali
- Automotive (caravan)
- Marine

Electric Pump 12V

Features

Hosetails 3/8" NPT.

3 chamber diaphragm pump, self priming, it runs dry.

Viton® valves, TPE diaphragm.

For continuous duty cycle.

Applications

- Agriculture
- Spraying
- Industry
- Automotive (caravan)
- Marine

Электронасос 12В

Характеристики

Вход/выход 3/8" NPT.

3-камерный диафрагменный самозаливной насос, может работать в сухом режиме.

Клапаны из Viton®, диафрагма из TPE.

Для непрерывного цикла работы.

Применение

- Сельское хозяйство
- Орошение
- Промышленность
- Автомобилестроение
- Морские сферы применения



Part No.	l/1'	bar	m	°C	Kg	V dc	A	Pack
8411000	5,5	5,5	1,8	60	2,6	12	8,0	1
8411017	5,5	6,9	1,8	60	2,6	12	8,5	1

DIMENSIONS

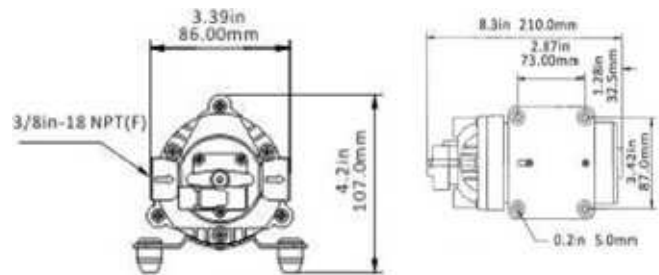



OPTIONALS



Pag. 42

Composizione del kit

Kit composed of / Комплектация

Description	Q.ty
GeoPump 	1
Hosetail 3/8" NPT 	2

GEOPUMP



Pompa elettrica 12V

Caratteristiche

ingresso/uscita attacco rapido
Per uso intermittente (30 min. on - 30 min. off).
2 pompanti a membrana, auto adescante, può funzionare a secco
Valvole in Viton® , membrana in TPE.

Applicazioni

- Agricole
- Irrorazione
- Industriali
- Automotive (caravan)
- Marine

Electric Pump 12V

Features

Hosetails 3/8".
For intermittent periodic duty cycles (30 min. on - 30 min. off).
2 chamber diaphragm pump, self priming, it runs dry.
Viton® valves, TPE diaphragm.

Applications

- Agriculture
- Spraying
- Industry
- Automotive (caravan)
- Marine

Электронасос 12В

Характеристики

Вход/выход с быстродействующим соединением.
Для прерывистого использования (30 мин. ON - 30 мин. OFF).
2-камерный диафрагменный самозаливной насос, может работать в сухом режиме.
Клапаны из Viton®, диафрагма из TPE.

Применение

- Сельское хозяйство
- Орошение
- Промышленность
- Автомобилестроение
- Морские сферы применения



Part No.	l/1'	bar	m	°C	Kg	V dc	A	Pack
8411002	3,8	2,4	1,2	43	0,57	12	2,5	1

DIMENSIONS

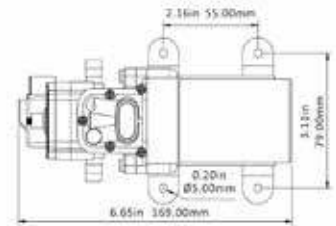
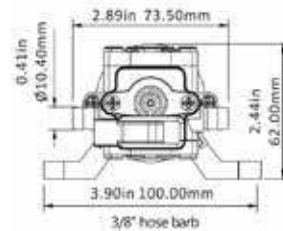

OPTIONALS



Pag. 42

Composizione del kit

Kit composed of / Комплектация

Description	Q.ty
GeoPump 	1

Valvola di regolazione manuale di massima pressione.

Manual adjustable pressure relief valve.

Ручной регулировочный клапан максимального давления.

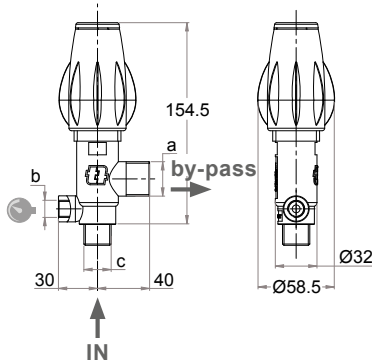

Part No.	l/1'	bar	by-pass		°C	Pack	
8384043	70	4	G 3/4 M	G 1/4 F	G 1/2 M	60	10
8384045					G 3/4 M		
8384044		10	G 3/4 M	G 1/4 F	G 1/2 M		
8384046					G 3/4 M		

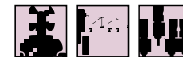

Part No.	l/1'	bar	by-pass		°C	Pack	
8384050	70	4			1/2 - 14 NPT	60	1
8384052			3/4 - 14 NPT	1/4 - 18 NPT	3/4 - 14 NPT		
8384051		10			1/2 - 14 NPT		

OPTIONALS



Pag. 346

Dispositivo di limitazione della pressione

Il dispositivo è stato realizzato nel rispetto della normativa europea che prevede il ritorno in cisterna del liquido fuoriuscito e il non superamento della pressione nominale dell'impianto del 20%. E' dotato di raccordo girevole che ne facilita il montaggio e di sigillo antimanomissione.

Il dispositivo deve essere assemblato su pompe facenti parte di sistemi complessi o venduto come ricambio originale di pompe per macchine irroratrici.

Pressure cut-off device

This device is manufactured in accordance with the EN standard, limiting overpressure to 20% more than working pressure, by-passing exceeding liquid to the tank. Easy to assemble thanks to the swivel inlet fitting and also provided with anti-tampering device.

This device must be fitted on pumps assembled on a complete spraying machine or can be sold as original spare part of the same kind of pump.

Устройство ограничения давления

Устройство было изготовлено при соблюдении требований европейского стандарта, который предполагает возврат в емкость вытекшей жидкости и не превышение номинального давления системы на 20%. Оснащено поворотным соединением, упрощающим монтажные операции, и пломбой. Устройство должно монтироваться на насосы, являющиеся составной частью комплексных систем, или продаваться как оригинальная запасная часть насосов для опрыскивателей.

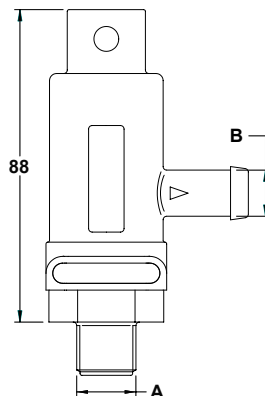

Part No.	l/1'	bar	°C	A	B	Ø mm	Pack
8300000	20+100	10	60	G 3/8	13	13	5
8300001		20					
8300002		30					
8300003		40					
8300004	100+200	50	60	G 1/2	19	19	5
8300005		10					
8300006		20					
8300007	100+150	50	60	G 1/2	19	19	5
8300011		50					
8300008	200+300	10	60	G 3/4	25	25	5
8300009		20					
8300012	150+260	50	60	G 3/4	25	25	

CONTROL UNITS COMPLETE WITH HOSETAILS

ST/DRIVER

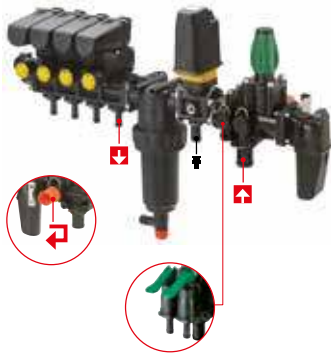

Part No.	Valves	IN		OUT				BY-PASS				G 1 M
		19	25	10	13	16	19	19	35	35	35	
8500000	5		●		●							●
8500003	5		●				●					●
8500009	5		●	●								●
8500012	3	●				●		●				
8500002	4		●		●					●		
8500007	4	●					●		●			

ST/DRIVER 06

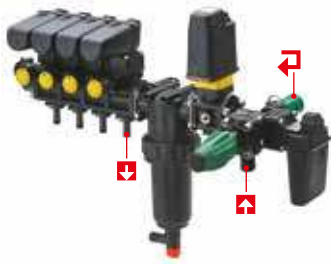

Part No.	Valves	IN		OUT				G 3/4 M	BY-PASS				G 1 M
		19	25	10	13	16	25		19	25	35	35	
8501040	3	●					●				●		
8501028	3		●		●								●
8501044	4	●		●				●					
8500008	5		●		●							●	
8501002	5		●		●								●
8501049	6	●				●				●			
8501024	7		●	●						●			

DRIVER

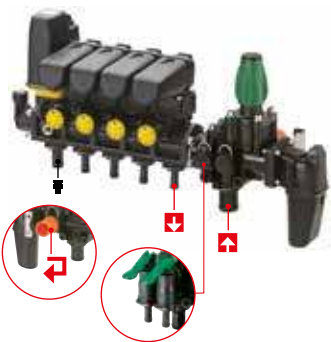

Part No.	Valves	IN		OUT				BY-PASS				
		19	25	10	13	16	19	25	35	35	35	
8502009	3		●				●			●		
8502010	3		●	●				●				
8502005	3	●			●						●	
8502007	4		●				●		●			
8502014	4		●	●								●
8502008	5		●				●			●		
8502019	5		●		●							●
8502021	5		●	●								●
8502018	6		●			●						●
8502024	6		●		●							●

DRIVER - 06

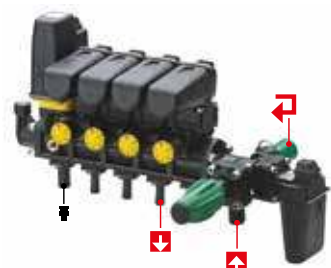

Part No.	Valves	IN		OUT				BY-PASS		
		19	25	10	13	16	19	25	35	35
8503034	4		●		●			●		
8503032	5		●	●				●		
8503031	5		●		●				●	
8503001	5		●		●					●
8503035	6		●		●			●		

ST/BASIC 206

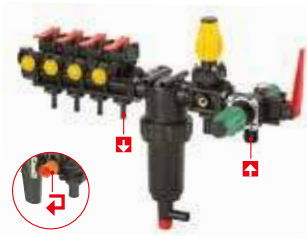

Part No.	Valves	IN		OUT			BY-PASS	
		Ø mm		Ø mm			Ø mm	
		25	10	13	19	25	35	
8519010	5	●		●			●	
8519012	5	●	●			●		
8519016	3	●		●		●		
8519023	3	●			●		●	
8519022	4	●	●			●		
8519004	6	●	●				●	

BASIC 206

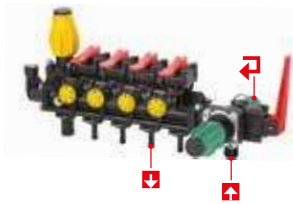

Part No.	Valves	IN		OUT		BY-PASS			
		Ø mm		Ø mm		Ø mm			
		19	25	10	13	25	35	35	G 1 M
8517037	3		●	●					●
8517028	3		●		●				●
8517044	3		●		●	●			
8517052	4		●		●		●		
8517057	4		●	●		●			
8517014	4	●			●			●	
8517034	5		●	●		●			
8517045	5		●		●	●			
8517031	5		●	●					●
8517056	7		●	●		●			

ST/START 06

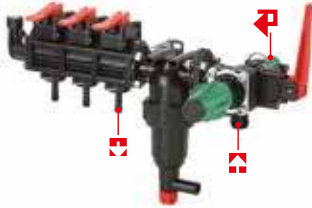

Part No.	Valves	IN		OUT			BY-PASS		
		Ø mm		Ø mm			Ø mm		
		19	25	10	13	19	25	35	35
8513011	3		●		●		●		
8513015	3		●			●	●		
8513032	3		●			●		●	
8512017	4	●		●				●	
8513012	4		●		●		●		
8513019	5		●		●		●		
8513024	5		●	●			●		
8513029	5		●			●	●		
8512018	6		●	●					●
8513017	6	●			●				●
8513025	6		●	●			●		

START 06

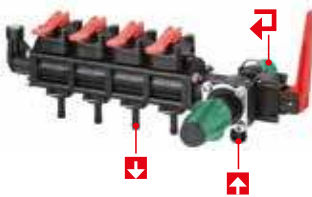

Part No.	Valves	IN		OUT			BY-PASS			
		Ø mm		Ø mm			Ø mm			
		19	25	10	13	25	35	35	35	G 1 M
8511006	3		●		●		●			
8511012	3		●	●		●				
8511018	3		●		●	●				
8511020	4		●	●						●
8511022	4		●	●					●	
8511029	6		●		●				●	
8511026	6	●			●			●		
8511059	5		●	●		●				
8511067	7		●	●		●				

START 08

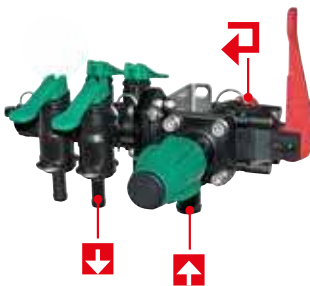

Part No.	Valves	IN		OUT		BY-PASS
		Ø mm		Ø mm		Ø mm
		19		13	19	G 1 M
8533030	4	●		●		●
8533029	4	●		●		●

ECOSTAR

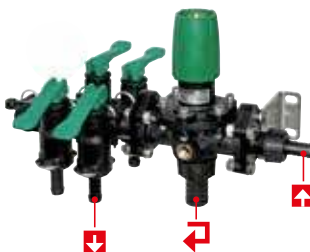

Part No.	Valves	IN		OUT	BY-PASS
		Ø mm		Ø mm	Ø mm
		25		10	19
8532004	4	●		●	●

LEGENDA

Caratteristiche / Features / Характеристики

 Pressione d'esercizio
Operating pressure
Рабочее давление

 Temperatura max
Max temperature
Максимальная температура

FEATURES

 **60°C**
Massima temperatura di esercizio
Maximum operating temperature
Максимальная рабочая температура

Valvole a sfera

Le valvole a sfera GEOLINE vengono realizzate in polipropilene, con guarnizioni in EPDM (Viton® a richiesta), particolari metallici esterni di fissaggio in ottone.

Ball valves

GEOLINE ball valves are in polypropylene, with EPDM gaskets (Viton® on demand), external fastening brass details.

Шаровые краны

Шаровые краны GEOLINE изготовлены из полипропилена с прокладками из EPDM (Viton® по заявке), внешние металлические крепежные детали из латуни.



Valvola a sfera 2 vie

- Struttura in polipropilene rinforzato con fibra di vetro per una maggiore robustezza e resistenza chimica.
- Sedi in Teflon garantiscono una facile maneggevolezza ed una buona tenuta.
- Guarnizioni in EPDM per trattamenti con fertilizzanti e agenti chimici. Viton® disponibile su richiesta.
- Pressione di lavoro per dimensioni fino a 1"1/4 PN 16, per dimensioni superiori PN 10;
- Disponibile anche in versione per montaggio a pannello (PM).

2-ways ball valve

- Fiberglass reinforced polypropylene body for strength and chemical resistance.
- Teflon seats for smooth operation and proper sealing characteristics.
- EPDM o-rings to handle most fertilizers and chemicals. Viton® on demand.
- Max operating pressure for sizes up to 1"1/4 PN 16 (232 PSI). For bigger sizes PN10 (145 PSI);
- Available also in panel mounting version (PM).

2-ходовой шаровой кран

- Корпус из полипропилена, усиленного стекловолокном в целях обеспечения большей прочности и химического сопротивления;
- Седла из тефлона обеспечивают оптимальную маневренность и хорошую герметичность;
- Прокладки из EPDM для использования с удобрениями и химическими средствами. Viton® по заявке;
- Рабочее давление для размеров до 1"1/4 PN 16, для больших размеров PN 10;
- Также в наличии имеется модель для установки на панель (PM).



Montaggio a pannello
Panel mounting
Панельная установка

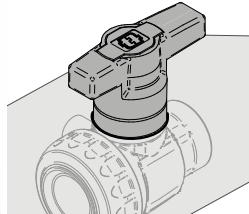

Dimensions
P. 154

Dimensions
P. 154

STD	PM								
Part No.	Part No.	F	Lever	°C	bar	Type	Pack		
8215102	-	G 3/8"	FF LL	60 ⇄ 16	-	10			
8215153	8217151	G 1/2"	FF LL	60 ⇄ 16	-	10			
8215203	8217201	G 3/4"	FF LL	60 ⇄ 16	-	10			
8215253	8217251	G 1"	FF LL	60 ⇄ 16	1	10			
8215303	8217301	G 1"1/4	FF LL	60 ⇄ 10	1	10			
8215353	8217351	G 1"1/2	FF LL	60 ⇄ 10	2	10			
8215403	8217401	G 2"	FF LL	60 ⇄ 10	2	10			
8215305	-	G 1"1/4	FF LC	60 ⇄ 10	1	10			
8215355	-	G 1"1/2	FF LC	60 ⇄ 10	2	10			
8215405	-	G 2"	FF LC	60 ⇄ 10	2	10			

Part No.	F	Lever	°C	bar	Type	Pack			
8215257	G 1"	MF LL	60 ⇄ 16	1	10				
8215307	G 1"1/4	MF LL	60 ⇄ 10	1	10				
8215357	G 1"1/2	MF LL	60 ⇄ 10	2	10				
8215407	G 2"	MF LL	60 ⇄ 10	2	10				
8215309	G 1"1/4	MF LC	60 ⇄ 10	1	10				
8215359	G 1"1/2	MF LC	60 ⇄ 10	2	10				
8215409	G 2"	MF LC	60 ⇄ 10	2	10				

MF= Male/Female LL= Long Lever LC= Short Lever

PM = Panel Mounting FF= Female/Female
LL= Long Lever LC= Short Lever

Flusso ON-OFF
ON-OFF flow
Поток ON-OFF



Valvola a sfera a 3 vie - ON-OFF e FLUSSO CONTINUO

- Evita l'innalzamento brusco della pressione durante la deviazione da una via all'altra.
- Struttura in polipropilene rinforzato con fibra di vetro per una maggiore robustezza e resistenza chimica.
- Sedi in Teflon garantiscono una facile maneggevolezza ed una buona tenuta.
- Guarnizioni in EPDM per trattamenti con fertilizzanti e agenti chimici. Viton® disponibile su richiesta.
- Pressione di lavoro per dimensioni fino a 1" PN 16, per dimensioni superiori PN 10.
- Filettature NPT a richiesta;
- Disponibile anche in versione per montaggio a pannello (PM).

3-ways ball valve - ON-OFF and CONTINUOUS FLOW

- To prevent overpressure when, selecting directional flow, the valve cannot be turned off.
- Fiberglass reinforced polypropylene body for strength and chemical resistance.
- Teflon seats for smooth operation and proper sealing.
- EPDM o-rings to handle most fertilizers and chemicals. Viton® on demand.
- Max operating pressure for sizes up to 1" PN 16 (232 PSI). For bigger sizes PN10 (145 PSI).
- NPT threads on demand;
- Available also in panel mounting version (PM).

3-ходовой шаровой клапан ВКЛ.-ВЫКЛ. и ПОСТОЯННЫЙ ПОТОК

- Предупреждает резкое повышение давления при переключении потока;
- Корпус из полипропилена, усиленного стекловолокном в целях обеспечения большей прочности и химического сопротивления;
- Седла из тефлона обеспечивают оптимальную маневренность и хорошую герметичность;
- Прокладки из EPDM для использования с удобрениями и химическими средствами. Viton® по заявке;
- Рабочее давление для размеров до 1" PN 16, для больших размеров PN 10;
- Резьба NPT по заявке;
- Также в наличии имеется модель для установки на панель (PM).



Montaggio a pannello
Panel mounting
Панельная установка

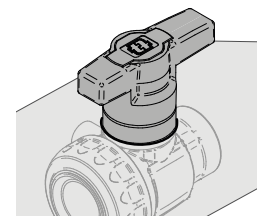

ON-OFF flow

Dimensions
P. 154

STD	PM								
Part No.	Part No.	F	Lever	°C	bar	Type	Pack		
8216151	8218151	G 1/2"	FF	LL	60 ⇔ 16	-	10		
8216201	8218201	G 3/4"	FF	LL	60 ⇔ 16	-	10		
8216252	8218251	G 1"	FF	LL	60 ⇔ 16	1	10		
8216307	8218301	G 1 1/4"	FF	LL	60 ⇔ 10	1	10		
8216357	8218351	G 1 1/2"	FF	LL	60 ⇔ 10	2	10		
8216407	8218401	G 2"	FF	LL	60 ⇔ 10	2	10		
8216309	-	G 1 1/4"	FF	LC	60 ⇔ 10	1	10		
8216359	-	G 1 1/2"	FF	LC	60 ⇔ 10	2	10		
8216409	-	G 2"	FF	LC	60 ⇔ 10	2	10		

PM = Panel Mounting **FF**= Female/Female
LL= Long Lever **LC**= Short Lever

Continuous flow

Dimensions
P. 154

STD	PM								
Part No.	Part No.	F	Lever	°C	bar	Type	Pack		
8216253	8218253	G 1"	FF	LL	60 ⇔ 16	1	10		
8216308	8218303	G 1 1/4"	FF	LL	60 ⇔ 10	1	10		
8216358	8218353	G 1 1/2"	FF	LL	60 ⇔ 10	2	10		
8216408	8218403	G 2"	FF	LL	60 ⇔ 10	2	10		
8216310	-	G 1 1/4"	FF	LC	60 ⇔ 10	1	10		
8216360	-	G 1 1/2"	FF	LC	60 ⇔ 10	2	10		
8216410	-	G 2"	FF	LC	60 ⇔ 10	2	10		

PM = Panel Mounting **FF**= Female/Female
LL= Long Lever **LC**= Short Lever

Flusso ON-OFF
ON-OFF flow
Поток ON-OFF

Flusso continuo
Continuous flow
Проточный

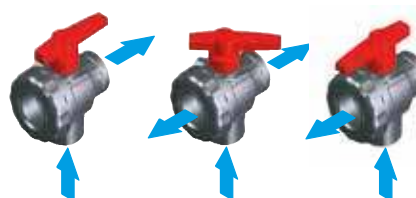
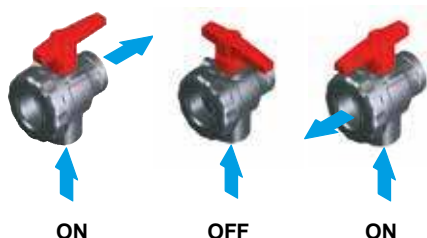

Valvola a sfera a 2 vie - ON-OFF - Cam lock

- Struttura in polipropilene rinforzato con fibra di vetro per una maggiore robustezza e resistenza chimica.
- Sedi in Teflon garantiscono una facile maneggevolezza ed una buona tenuta.
- Guarnizioni in EPDM per trattamenti con fertilizzanti e agenti chimici. Viton® disponibile su richiesta.
- Pressione di lavoro per dimensioni fino a 1"1/4 PN 16, per dimensioni superiori PN 10;
- Disponibile anche in versione per montaggio a pannello (PM).

2-ways ball valve - ON-OFF - Cam lock

- Fiberglass reinforced polypropylene body for strength and chemical resistance.
- Teflon seats for smooth operation and proper sealing characteristics.
- EPDM o-rings to handle most fertilizers and chemicals. Viton® on demand.
- Max operating pressure for sizes up to 1"1/4 PN 16 (232 PSI). For bigger sizes PN10 (145 PSI);
- Available also in panel mounting version (PM).

**2-ходовой шаровой клапан
ВКЛ.-ВЫКЛ. - Cam lock**

- Корпус из полипропилена, усиленного стекловолокном в целях обеспечения большей прочности и химического сопротивления;
- Седла из тефлона обеспечивают оптимальную маневренность и хорошую герметичность;
- Прокладки из EPDM для использования с удобрениями и химическими средствами. Viton® по заявке;
- Рабочее давление для размеров до 1"1/4 PN 16, для больших размеров PN 10;
- Также в наличии имеется модель для установки на панель (PM).

NEW

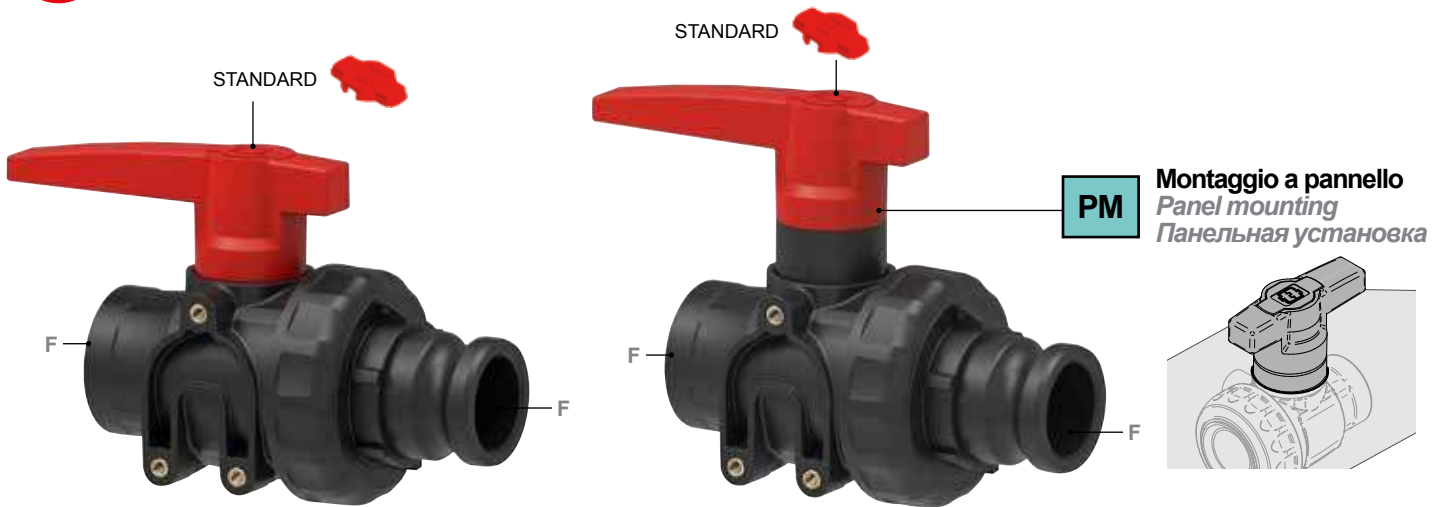

Dimensions
P. 155

		STD		PM					
Part No.	Part No.	F	Lever	°C	bar	Type	Pack		
8215362	8217358	G 1"1/2	FF LC	60	⇒ 10	2	10		
8215412	8217408	G 2"	FF LL	60	⇒ 10	2	10		

PM = Panel Mounting **FF**= Female/Female
LL= Long Lever

Flusso ON-OFF
ON-OFF flow
Поток ON-OFF



Valvola a sfera a 3 vie - ON-OFF - Cam lock

- Evita l'innalzamento brusco della pressione durante la deviazione da una via all'altra.
- Struttura in polipropilene rinforzato con fibra di vetro per una maggiore robustezza e resistenza chimica.
- Sedi in Teflon garantiscono una facile maneggevolezza ed una buona tenuta.
- Guarnizioni in EPDM per trattamenti con fertilizzanti e agenti chimici. Viton® disponibile su richiesta.
- Pressione di lavoro per dimensioni fino a 1" PN 16, per dimensioni superiori PN 10.
- Filettature NPT a richiesta;
- Disponibile anche in versione per montaggio a pannello (PM).

3-ways ball valve - ON-OFF - Cam lock

- To prevent overpressure when, selecting directional flow, the valve cannot be turned off.
- Fiberglass reinforced polypropylene body for strength and chemical resistance.
- Teflon seats for smooth operation and proper sealing.
- EPDM o-rings to handle most fertilizers and chemicals. Viton® on demand.
- Max operating pressure for sizes up to 1" PN 16 (232 PSI). For bigger sizes PN10 (145 PSI).
- NPT threads on demand;
- Available also in panel mounting version (PM).

**3-ходовой шаровой клапан
ВКЛ.-ВЫКЛ. - Cam lock**

- Предупреждает резкое повышение давления при переключении потока;
- Корпус из полипропилена, усиленного стекловолокном в целях обеспечения большей прочности и химического сопротивления;
- Седла из тефлона обеспечивают оптимальную маневренность и хорошую герметичность;
- Прокладки из EPDM для использования с удобрениями и химическими средствами. Viton® по заявке;
- Рабочее давление для размеров до 1" PN 16, для больших размеров PN 10;
- Резьба NPT по заявке;
- Также в наличии имеется модель для установки на панель (PM).

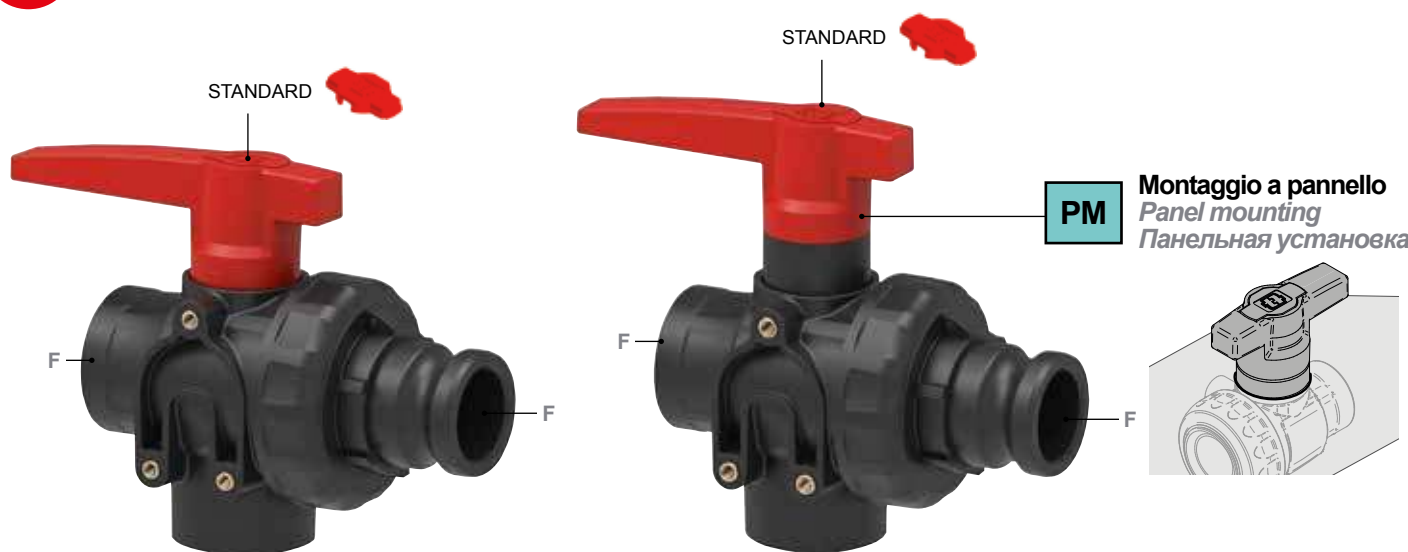

Dimensions
P. 155

STD	PM							
Part No.	Part No.	F	Lever	°C	bar	Type	Pack	
8216374	8218365	G 1"1/2	FF	LC	60 ⇌ 10	2	10	
8216424	8218410	G 2"	FF	LL	60 ⇌ 10	2	10	

PM = Panel Mounting **FF**= Female/Female
LL= Long Lever

Flusso ON-OFF
ON-OFF flow
Поток ON-OFF

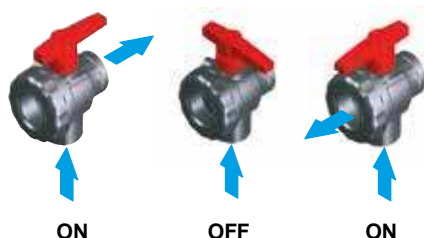

Valvola a sfera a 3 vie - ON-OFF e FLUSSO CONTINUO

- Evita l'innalzamento brusco della pressione durante la deviazione da una via all'altra;
- Struttura in polipropilene rinforzato con fibra di vetro per una maggiore robustezza e resistenza chimica;
- Sedi in Teflon garantiscono una facile maneggevolezza ed una buona tenuta;
- Guarnizioni in EPDM per trattamenti con fertilizzanti e agenti chimici. Viton® disponibile su richiesta;
- Pressione di lavoro per dimensioni fino a 1"1/4 PN 16, per dimensioni superiori PN 10;
- Filettature NPT a richiesta.

3-ways ball valve - ON-OFF and CONTINUOUS FLOW

- To prevent overpressure when, selecting directional flow, the valve cannot be turned off.
- Fiberglass reinforced polypropylene body for strength and chemical resistance.
- Teflon seats for smooth operation and proper sealing.
- EPDM o-rings to handle most fertilizers and chemicals. Viton® on demand.
- Max operating pressure for sizes up to 1"1/4 PN 16 (232 PSI). For bigger sizes PN10 (145 PSI).
- NPT threads on demand.

**3-ходовой шаровой клапан
ВКЛ.-ВЫКЛ. и ПОСТОЯННЫЙ ПОТОК**

- Предупреждает резкое повышение давления при переключении потока.
- Корпус из полипропилена, усиленного стекловолокном в целях обеспечения большей прочности и химического сопротивления.
- Седла из тефлона обеспечивают оптимальную маневренность и хорошую герметичность.
- Прокладки из EPDM для использования с удобрениями и химическими средствами. Viton® по заявке.
- Рабочее давление для размеров до 1"1/4 PN 16, для больших размеров PN 10.
- Резьба NPT по заявке.



ON-OFF flow

Dimensions
P. 156



Part No.	F	Lever	°C	bar	Type	Pack
8216256	G 1"	MF LL	60 ⇔ 16	1	10	
8216311	G 1"1/4	MF LL	60 ⇔ 10	1	10	
8216361	G 1"1/2	MF LL	60 ⇔ 10	2	10	
8216411	G 2"	MF LL	60 ⇔ 10	2	10	
8216313	G 1"1/4	MF LC	60 ⇔ 10	1	10	
8216363	G 1"1/2	MF LC	60 ⇔ 10	2	10	
8216413	G 2"	MF LC	60 ⇔ 10	2	10	

MF= Male/Female LL= Long Lever LC= Short Lever

Continuous flow

Dimensions
P. 156



Part No.	F	Lever	°C	bar	Type	Pack
8216257	G 1"	MF LL	60 ⇔ 16	1	10	
8216312	G 1"1/4	MF LL	60 ⇔ 10	1	10	
8216362	G 1"1/2	MF LL	60 ⇔ 10	2	10	
8216412	G 2"	MF LL	60 ⇔ 10	2	10	
8216314	G 1"1/4	MF LC	60 ⇔ 10	1	10	
8216364	G 1"1/2	MF LC	60 ⇔ 10	2	10	
8216414	G 2"	MF LC	60 ⇔ 10	2	10	

MF= Male/Female LL= Long Lever LC= Short Lever

Flusso ON-OFF
ON-OFF flow
Поток ON-OFF

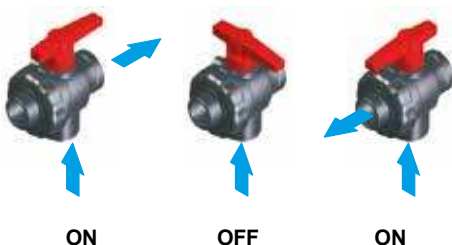

Flusso continuo
Continuous flow
Проточный



Valvola a sfera 2 vie

- Struttura in polipropilene rinforzato con fibra di vetro per una maggiore robustezza e resistenza chimica;
- Sedi in Teflon garantiscono una facile maneggevolezza ed una buona tenuta;
- Guarnizioni in EPDM per trattamenti con fertilizzanti e agenti chimici. Viton® disponibile su richiesta;
- Pressione di lavoro per dimensioni fino a 1"1/4 PN 16, per dimensioni superiori PN 10;
- Disponibile anche in versione per montaggio a pannello (PM).

2-ways ball valve

- Fiberglass reinforced polypropylene body for strength and chemical resistance;
- Teflon seats for smooth operation and proper sealing characteristics;
- EPDM o-rings to handle most fertilizers and chemicals. Viton® on demand;
- Max operating pressure for sizes up to 1"1/4 PN 16 (232 PSI). For bigger sizes PN10 (145 PSI);
- Available also in panel mounting version (PM).

2-ходовой шаровой кран

- Корпус из полипропилена, усиленного стекловолокном в целях обеспечения большей прочности и химического сопротивления;
- Седла из тефлона обеспечивают оптимальную маневренность и хорошую герметичность;
- Прокладки из EPDM для использования с удобрениями и химическими средствами. Viton® по заявке;
- Рабочее давление для размеров до 1"1/4 PN 16, для больших размеров PN 10;
- Также в наличии имеется модель для установки на панель (PM).

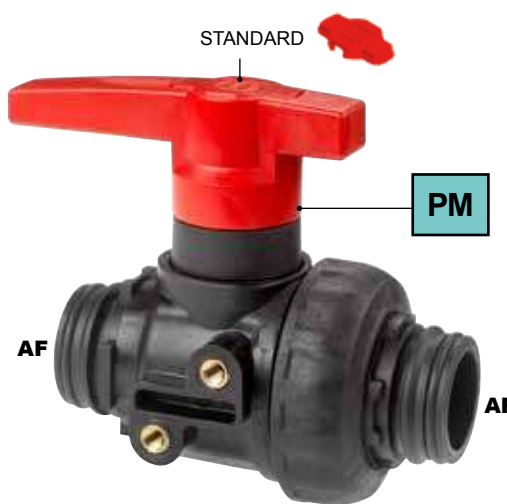

Montaggio a pannello
Panel mounting
Панельная установка

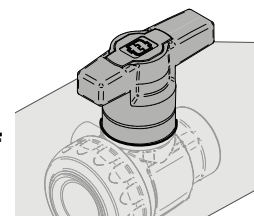

Dimensions
P. 157

STD		PM			↓	⊗		
Part No.	Part No.	AF	Lever	°C	bar	Type	Pack	
8215601	8217601	3	LL	60	⇔ 16	-	10	
NEW	8215651	4	LL	60	16	1	10	
	8215701	5	LL	60	⇔ 10	1	10	
	8215751	6	LL	60	⇔ 10	2	10	
	8215801	7	LL	60	⇔ 8	2	10	
	8215704	-	5	LC	60	⇔ 10	1	10
	8215754	-	6	LC	60	⇔ 10	2	10
	8215804	-	7	LC	60	⇔ 8	2	10

PM = Panel Mounting **LL**= Long Lever **LC**= Short Lever

Flusso ON-OFF
ON-OFF flow
Поток ON-OFF



Valvola a sfera a 3 vie - ON-OFF e FLUSSO CONTINUO

- Evita l'innalzamento brusco della pressione durante la deviazione da una via all'altra;
- Struttura in polipropilene rinforzato con fibra di vetro per una maggiore robustezza e resistenza chimica;
- Sedi in Teflon garantiscono una facile maneggevolezza ed una buona tenuta;
- Guarnizioni in EPDM per trattamenti con fertilizzanti e agenti chimici. Viton® disponibile su richiesta;
- Pressione di lavoro per dimensioni fino a 1"1/4 PN 16, per dimensioni superiori PN 10;
- Disponibile anche in versione per montaggio a pannello (PM).

3-ways ball valve - ON-OFF and CONTINUOUS FLOW

- To prevent overpressure when, selecting directional flow, the valve cannot be turned off;
- Fiberglass reinforced polypropylene body for strength and chemical resistance;
- Teflon seats for smooth operation and proper sealing;
- EPDM o-rings to handle most fertilizers and chemicals. Viton® on demand;
- Max operating pressure for sizes up to 1"1/4 PN 16 (232 PSI). For bigger sizes PN10 (145 PSI);
- Available also in panel mounting version (PM).

3-ходовой шаровой клапан ВКЛ.-ВЫКЛ. и ПОСТОЯННЫЙ ПОТОК

- Предупреждает резкое повышение давления при переключении потока;
- Корпус из полипропилена, усиленного стекловолокном в целях обеспечения большей прочности и химического сопротивления;
- Седла из тефлона обеспечивают оптимальную маневренность и хорошую герметичность;
- Прокладки из EPDM для использования с удобрениями и химическими средствами. Viton® по заявке;
- Рабочее давление для размеров до 1"1/4 PN 16, для больших размеров PN 10;
- Также в наличии имеется модель для установки на панель (PM).

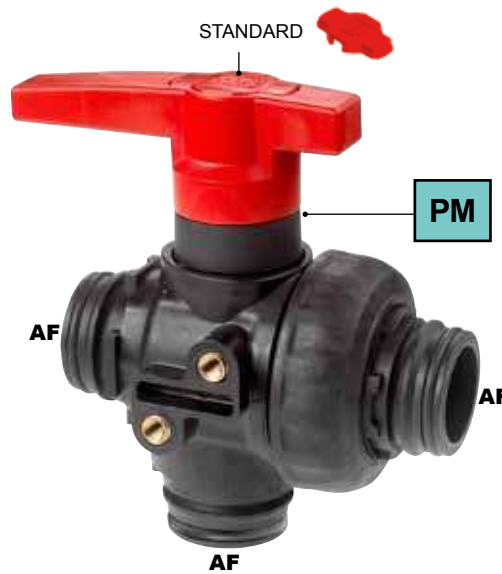

PM Montaggio a pannello
Panel mounting
Панельная установка

ON-OFF flow

Dimensions
P. 157

NEW

STD		PM					
Part No.	Part No.	AF	Lever	°C	bar	Pack	
8216601	8218601	3	FF LL	60 ⇌ 16	10		
8216651	8218651	4	FF LL	60 ⇌ 16	10		
8216701	8218701	5	FF LL	60 ⇌ 10	10		
8216751	8218751	6	FF LL	60 ⇌ 10	10		
8216801	8218801	7	FF LL	60 ⇌ 8	10		
8216704	-	5	FF LC	60 ⇌ 10	10		
8216754	-	6	FF LC	60 ⇌ 10	10		
8216804	-	7	FF LC	60 ⇌ 8	10		

PM = Panel Mounting **FF**= Female/Female
LL= Long Lever **LC**= Short Lever

Continuous flow

Dimensions
P. 157

NEW

STD		PM					
Part No.	Part No.	AF	Lever	°C	bar	Pack	
8216653	8218653	4	FF LL	60 ⇌ 16	10		
8216703	8218703	5	FF LL	60 ⇌ 10	10		
8216753	8218753	6	FF LL	60 ⇌ 10	10		
8216803	8218803	7	FF LL	60 ⇌ 8	10		
8216706	-	5	FF LC	60 ⇌ 10	10		
8216756	-	6	FF LC	60 ⇌ 10	10		
8216806	-	7	FF LC	60 ⇌ 8	10		

PM = Panel Mounting **FF**= Female/Female
LL= Long Lever **LC**= Short Lever

Flusso ON-OFF
ON-OFF flow
Поток ON-OFF



Flusso continuo
Continuous flow
Проточный



Valvola a sfera a 3 vie

- Struttura in polipropilene rinforzato con fibra di vetro per una maggiore robustezza e resistenza chimica;
- Sedi in Teflon garantiscono una facile maneggevolezza ed una buona tenuta;
- Guarnizioni in EPDM per trattamenti con fertilizzanti e agenti chimici. Viton® disponibile su richiesta;
- Pressione di lavoro per dimensioni fino a 1"1/4 PN 16, per dimensioni superiori PN 10;
- Disponibile anche in versione per montaggio a pannello (PM).

3-ways ball valve

- Fiberglass reinforced polypropylene body for strength and chemical resistance;
- Teflon seats for smooth operation and proper sealing characteristics;
- EPDM o-rings to handle most fertilizers and chemicals. Viton® on demande;
- Max operating pressure for sizes up to 1"1/4 PN 16 (232 PSI). For bigger sizes PN10 (145 PSI);
- Available also in panel mounting version (PM).

3-ходовой шаровой кран

- Корпус из полипропилена, усиленного стекловолокном в целях обеспечения большей прочности и химического сопротивления;
- Седла из тefлона обеспечивают оптимальную маневренность и хорошую герметичность;
- Прокладки из EPDM для использования с удобрениями и химическими средствами. Viton® по заявке;
- Рабочее давление для размеров до 1"1/4 PN 16, для больших размеров PN 10;
- Также в наличии имеется модель для установки на панель (PM).

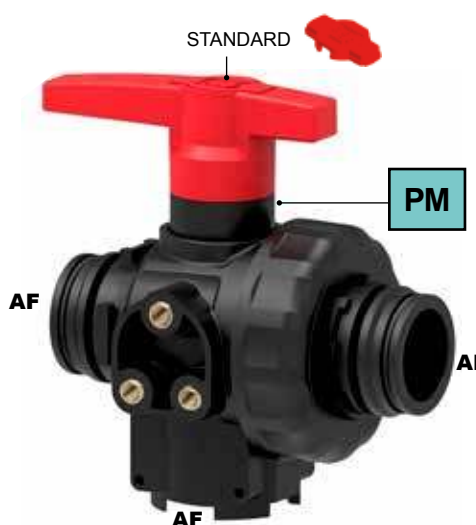

Montaggio a pannello
Panel mounting
Панельная установка

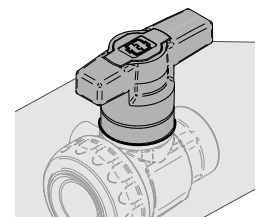

ON-OFF flow		Dimensions P. 158						
STD	PM							
Part No.	Part No.	AF	Lever	°C	bar	Type	Pack	
8216776	8218776	6	MF LL	60 ⇌ 10	2	10		

PM = Panel Mounting MF= Male/Female LL= Long Lever

Continuous flow		Dimensions P. 158						
STD	PM							
Part No.	Part No.	AF	Lever	°C	bar	Type	Pack	
8216778	8218778	6	MF LL	60 ⇌ 10	2	10		

PM = Panel Mounting MF= Male/Female LL= Long Lever

Flusso ON-OFF
ON-OFF flow
Поток ON-OFF

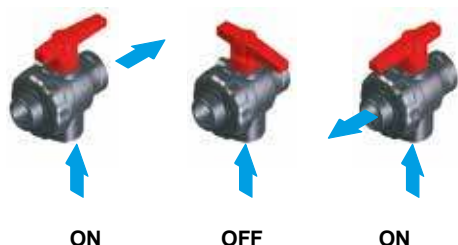

Flusso continuo
Continuous flow
Проточный

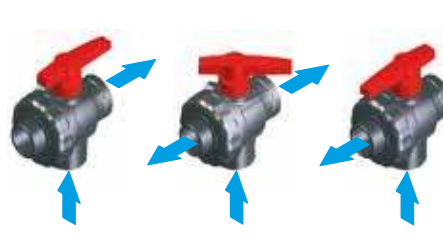

Valvola a sfera 2 vie - NPT

- Struttura in polipropilene rinforzato con fibra di vetro per una maggiore robustezza e resistenza chimica;
 - Sedi in Teflon garantiscono una facile maneggevolezza ed una buona tenuta;
 - Guarnizioni in EPDM per trattamenti con fertilizzanti e agenti chimici.
- Viton® disponibile su richiesta;
- Pressione di lavoro per dimensioni fino a 1"1/4 PN 16, per dimensioni superiori PN 10.

2-ways ball valve - NPT

- Fiberglass reinforced polypropylene body for strength and chemical resistance;
- Teflon seats for smooth operation and proper sealing characteristics;
- EPDM o-rings to handle most fertilizers and chemicals. Viton® on demand;
- Max operating pressure for sizes up to 1"1/4 PN 16 (232 PSI). For bigger sizes PN10 (145 PSI).

2-ходовой шаровой кран - NPT

- Корпус из полипропилена, усиленного стекловолокном в целях обеспечения большей прочности и химического сопротивления;
- Седла из тефлона обеспечивают оптимальную маневренность и хорошую герметичность;
- Прокладки из EPDM для использования с удобрениями и химическими средствами. Viton® по заявке;
- Рабочее давление для размеров до 1"1/4 PN 16, для больших размеров PN 10.



DIMENSIONS

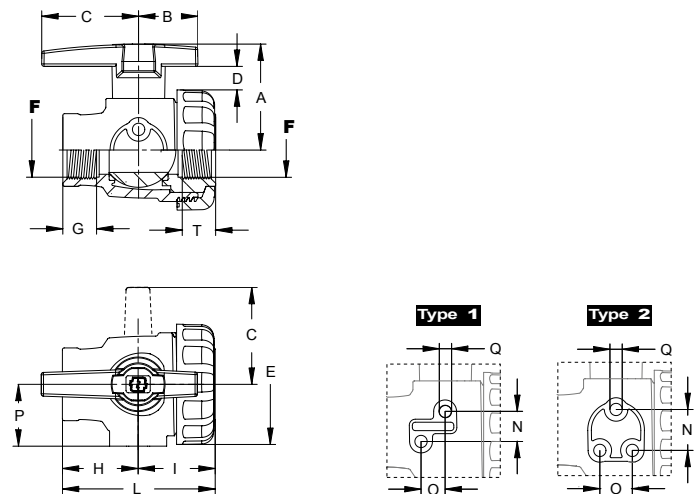

Part No.	F (NPT)	Lever	A	B	C	D	E	G	H	I	L	N	O	P	Q	T	°C	bar	Type	Pack		
8215127	3/8"	FF	LL	60	42	42	16	59	23	43,5	44,5	88	-	-	-	23	60	⇔	16	-	10	
8215228	3/4"	FF	LL	60	42	42	16	59	23	43,5	44,5	88	-	-	-	23	60	⇔	16	-	10	
8215178	1/2"	FF	LL	60	42	42	16	59	23	43,5	44,5	88	-	-	-	23	60	⇔	16	-	10	
8215278	1"	FF	LL	73	42	53	20	69	23	46,5	52	98,5	25	20	37	M8	25	60	⇔	16	1	10
8215328	1"1/4	FF	LL	80	42	77	20	82	25	53,5	55	108,5	25	20	43	M8	26	60	⇔	10	1	10
8215378	1"1/2	FF	LL	87	49	80	20	99	28	62,5	63,5	126	34	27	51	M8	28	60	⇔	10	2	10
8215428	2"	FF	LL	110	49	130	25	115	30	73	75,5	148,5	78	43	51	M8	30	60	⇔	10	2	10

FF = Female/Female LL = Long Lever LC = Short Lever

Flusso ON-OFF
ON-OFF flow
Поток ON-OFF



Valvola a sfera a 3 vie - NPT

- Struttura in polipropilene rinforzato con fibra di vetro per una maggiore robustezza e resistenza chimica;
- Sedi in Teflon garantiscono una facile maneggevolezza ed una buona tenuta;
- Guarnizioni in EPDM per trattamenti con fertilizzanti e agenti chimici. Viton® disponibile su richiesta;
- Pressione di lavoro per dimensioni fino a 1"1/4 PN 16, per dimensioni superiori PN 10.

3-ways ball valve - NPT

- Fiberglass reinforced polypropylene body for strength and chemical resistance;
- Teflon seats for smooth operation and proper sealing characteristics;
- EPDM o-rings to handle most fertilizers and chemicals. Viton® on demande;
- Max operating pressure for sizes up to 1"1/4 PN 16 (232 PSI). For bigger sizes PN10 (145 PSI).

3-ходовой шаровой кран - NPT

- Корпус из полипропилена, усиленного стекловолокном в целях обеспечения большей прочности и химического сопротивления;
- Седла из тефлона обеспечивают оптимальную маневренность и хорошую герметичность;
- Прокладки из EPDM для использования с удобрениями и химическими средствами. Viton® по заявке.
- Рабочее давление для размеров до 1"1/4 PN 16, для больших размеров PN 10.



DIMENSIONS

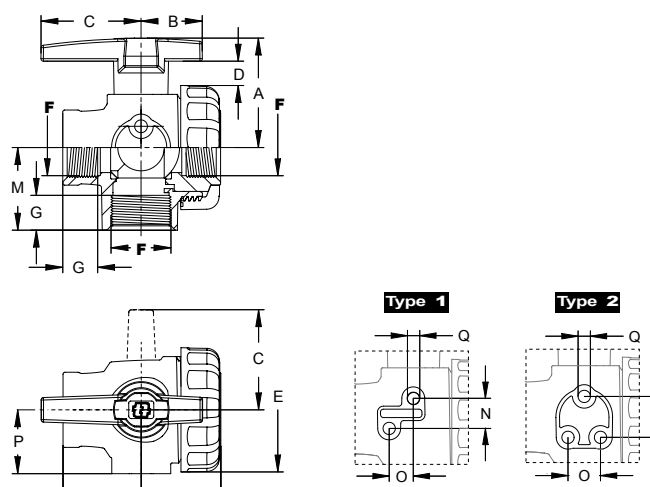

Part No.	F (NPT)	Lever	A	B	C	D	E	G	H	I	L	M	N	O	P	Q	T	°C	bar	Type	Pack		
			mm	mm	mm	mm	mm	mm	mm	mm	mm	mm	mm	mm	mm	mm	mm						
8216180	1/2"	FF	LL	60	42	42	16	59	23	43,5	44,5	88	42	-	-	-	-	23	60	⇒	16	-	10
8216230	3/4"	FF	LL	60	42	42	16	59	23	43,5	44,5	88	42	-	-	-	-	23	60	⇒	16	-	10
8216276	1"	FF	LL	73	42	53	20	69	23	46,5	52	98,5	47	25	20	37	M8	25	60	⇒	16	1	10
8216330	1"1/4	FF	LL	80	42	77	20	82	25	53,5	55	108,5	53,5	25	20	43	M8	26	60	⇒	10	1	10
8216380	1"1/2	FF	LL	87	49	80	20	99	28	62,5	63,5	126	66	34	27	51	M8	28	60	⇒	10	2	10
8216428	2"	FF	LL	110	49	130	25	115	30	73	75,5	148,5	81	78	43	51	M8	30	60	⇒	10	2	10

FF = Female/Female LL = Long Lever LC = Short Lever

Flusso ON-OFF
ON-OFF flow
Поток ON-OFF

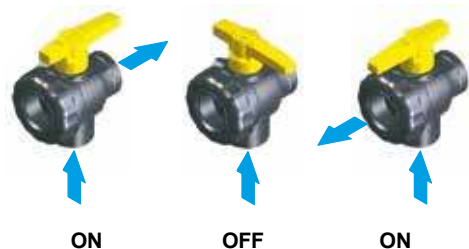

DIMENSIONS

2-ways ball valve - FF

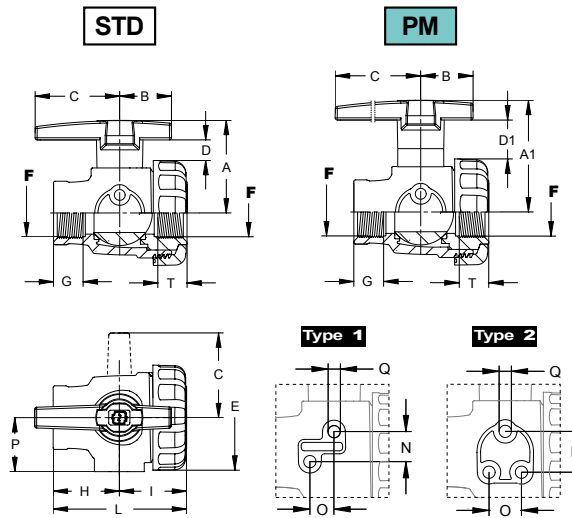

F	Lever	A	A1	B	C	D	D1	E	G	H	I	L	N	O	P	Q	T	Type
		mm	mm	mm	mm	mm	mm	mm	mm	mm	mm	mm	mm	mm	mm	mm	mm	
G 3/8"	FF LL	60	-	42	42	16	-	59	14	43,5	39	74	-	-	-	-	14	-
G 1/2"	FF LL	60	82	42	42	16	38	59	23	43,5	44,5	88	-	-	-	-	23	-
G 3/4"	FF LL	60	82	42	42	16	38	59	23	43,5	44,5	88	-	-	-	-	23	-
G 1"	FF LL	73	89	42	53	20	36	69	23	46,5	52	98,5	25	20	37	M8	25	1
G 1 1/4"	FF LL	80	96	42	77	20	36	82	25	53,5	55	108,5	25	20	43	M8	26	1
G 1 1/2"	FF LL	87	103	49	80	20	36	99	28	62,5	63,5	126	34	27	51	M8	28	2
G 2"	FF LL	110	136	49	130	25	47	115	30	73	75,5	148,5	78	43	51	M8	30	2
G 1 1/4"	FF LC	80	-	42	50	20	-	82	25	53,5	55	108,5	25	20	37	M8	26	1
G 1 1/2"	FF LC	87	-	49	60	20	-	99	28	62,5	63,5	126	34	27	51	M8	28	2
G 2"	FF LC	110	-	75	75	25	-	115	30	73	75,5	148,5	78	43	51	M8	30	2

DIMENSIONS

2-ways ball valve - MF

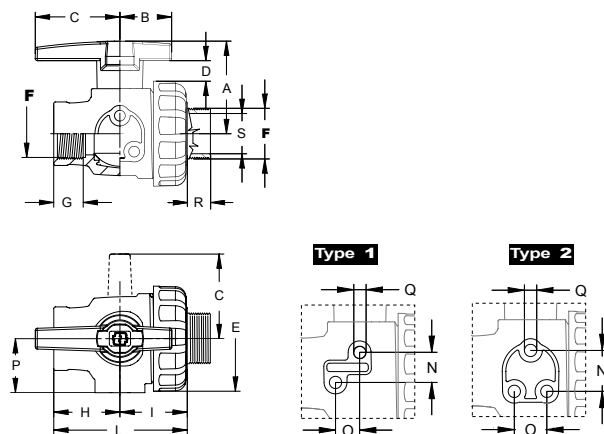

F	Lever	A	B	C	D	E	G	H	I	L	N	O	P	Q	R	S	T	Type
		mm	mm	mm	mm	mm	mm	mm	mm	mm	mm	mm	mm	mm	mm	mm	mm	
G 1"	MF LL	73	42	53	20	69	23	46,5	52	98,5	25	20	37	M8	22	25	25	1
G 1 1/4"	MF LL	80	42	77	20	82	25	53,5	55	108,5	25	20	43	M8	22	32	26	1
G 1 1/2"	MF LL	87	49	80	20	99	28	62,5	63,5	126	34	27	51	M8	22	38	28	2
G 2"	MF LL	110	49	130	25	115	30	73	75,5	148,5	78	43	51	M8	25	48	30	2
G 1 1/4"	MF LC	80	42	50	20	82	25	53,5	55	108,5	25	20	37	M8	22	25	26	1
G 1 1/2"	MF LC	87	49	60	20	99	28	62,5	63,5	126	34	27	51	M8	22	32	28	2
G 2"	MF LC	110	75	75	25	115	30	73	75,5	148,5	78	43	51	M8	22	38	30	2

DIMENSIONS

2-ways ball valve - Cam lock

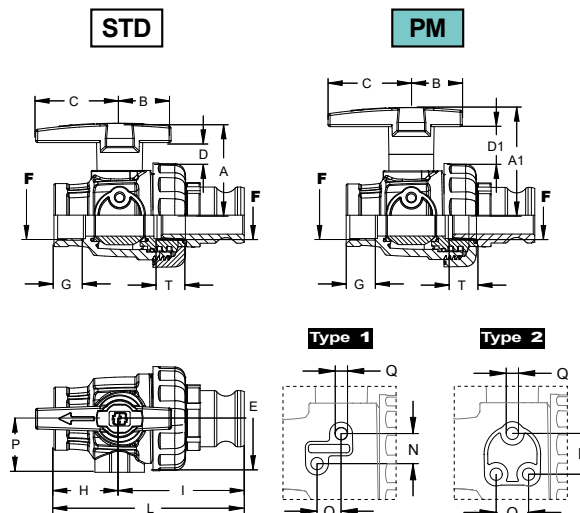

F	Lever	A	A1	B	C	D	D1	E	G	H	I	L	N	O	P	Q	T	Type
		mm	mm	mm	mm	mm	mm	mm	mm	mm	mm	mm	mm	mm	mm	mm	mm	
G 1 1/2	FF LC	87	-	49	60	20	-	99	28	62,5	118,6	181	34	27	51	M8	28	2
G 2"	FF LL	110	136	49	130	25	47	115	30	73	137,6	210,6	78	43	51	M8	30	2

DIMENSIONS

3-ways ball valve - Cam lock

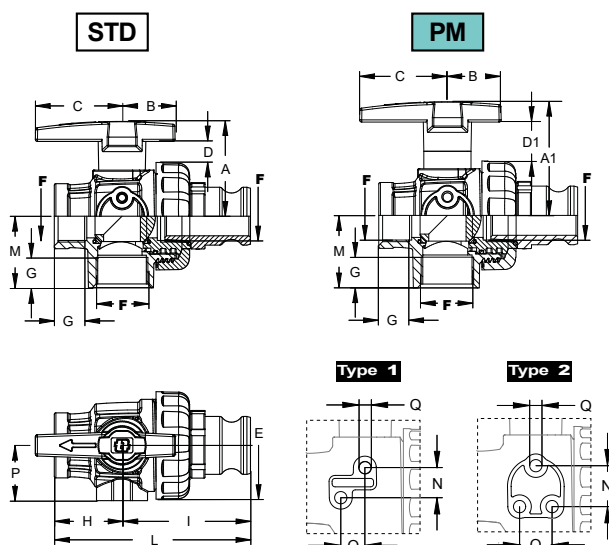

F	Lever	A	A1	B	C	D	D1	E	G	H	I	L	M	N	O	P	Q	T	Type
		mm	mm	mm	mm	mm	mm	mm	mm	mm	mm	mm	mm	mm	mm	mm	mm	mm	
G 1 1/2	FF LC	87	-	49	60	20	-	99	28	62,5	118,6	181	66	34	27	51	M8	28	2
G 2"	FF LL	110	136	49	130	25	51	115	30	73	137,6	210,6	81	78	43	51	M8	30	2

DIMENSIONS

3-ways ball valve - FF

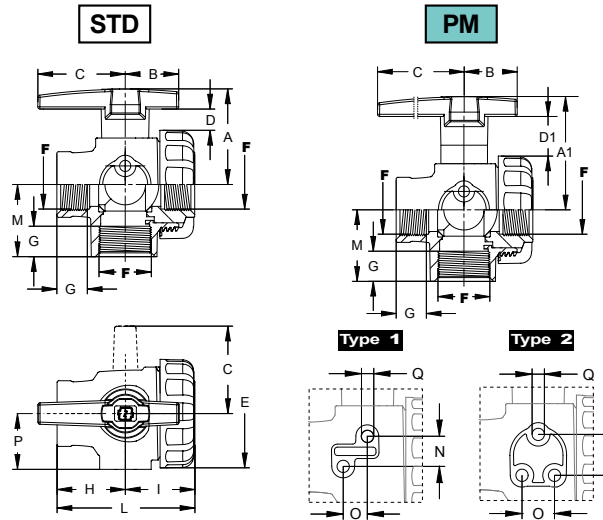

F	Lever	A	A1	B	C	D	D1	E	G	H	I	L	M	N	O	P	Q	T	Type
		mm	mm	mm	mm	mm	mm	mm	mm	mm	mm	mm	mm	mm	mm	mm	mm	mm	
G 1/2"	FF LL	60	82	42	42	16	38	59	23	43,5	44,5	88	42	-	-	-	-	23	-
G 3/4"	FF LL	60	82	42	42	16	38	59	23	43,5	44,5	88	42	-	-	-	-	23	-
G 1"	FF LL	73	89	42	53	20	36	69	23	46,5	52	98,5	47	25	20	37	M8	25	1
G 1 1/4"	FF LL	80	96	42	77	20	36	82	25	53,5	55	108,5	53,5	25	20	43	M8	26	1
G 1 1/2"	FF LL	87	103	49	80	20	36	99	28	62,5	63,5	126	66	34	27	51	M8	28	2
G 2"	FF LL	110	136	49	130	25	51	115	30	73	75,5	148,5	81	78	43	51	M8	30	2
G 1 1/4"	FF LC	80	-	42	50	20	-	82	25	53,5	55	108,5	53,5	25	20	43	M8	26	1
G 1 1/2"	FF LC	87	-	49	60	20	-	99	28	62,5	63,5	126	66	34	27	51	M8	28	2
G 2"	FF LC	110	-	75	75	25	-	115	30	73	75,5	148,5	81	78	43	51	M8	30	2

DIMENSIONS

3-ways ball valve - MF

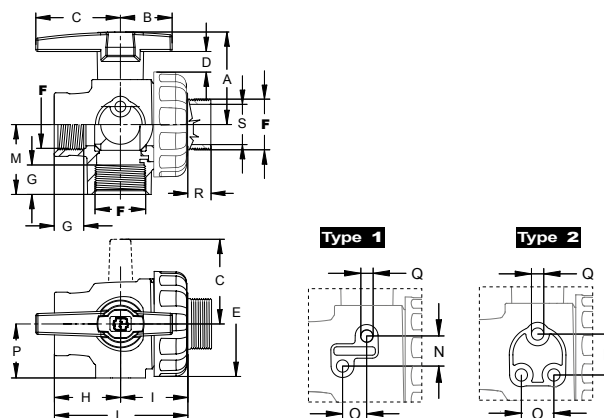

F	Lever	A	B	C	D	E	G	H	I	L	M	N	O	P	Q	R	S	Type
		mm	mm	mm	mm	mm	mm	mm	mm	mm	mm	mm	mm	mm	mm	mm	mm	
G 1"	MF LL	73	42	53	20	69	23	46,5	52	98,5	47	25	20	37	M8	22	25	1
G 1 1/4"	MF LL	80	42	77	20	82	25	53,5	55	108,5	53,5	25	20	43	M8	22	32	1
G 1 1/2"	MF LL	87	49	80	20	99	28	62,5	63,5	126	66	34	27	51	M8	22	38	2
G 2"	MF LL	110	49	130	25	115	30	73	75,5	148,5	81	78	43	51	M8	25	48	2
G 1 1/4"	MF LC	80	42	50	20	82	25	53,5	55	108,5	53,5	25	20	43	M8	22	32	1
G 1 1/2"	MF LC	87	49	60	20	99	28	62,5	63,5	126	66	34	27	51	M8	22	38	2
G 2"	MF LC	110	75	75	25	115	30	73	75,5	148,5	81	78	43	51	M8	25	48	2

DIMENSIONS

2-ways ball valve - FF - AF

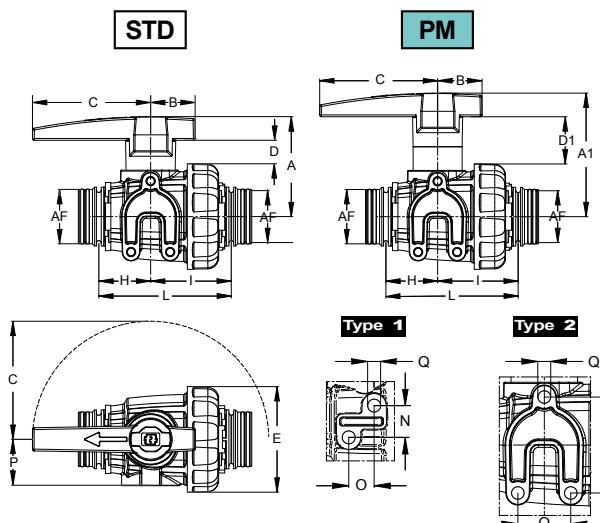

AF	Lever	A	A1	B	C	D	D1	E	H	I	L	N	O	P	Q	Type
mm		mm	mm	mm	mm	mm	mm	mm	mm	mm	mm	mm	mm	mm		
3	FF LL	60	82	42	42	16	38	59	33	52	85	-	-	-	-	-
4	FF LL	73	89	42	53	20	36	69	34	60	94	25	20	37	M8	1
5	FF LL	80	97	42	80	20	36	82	38	64	102	25	20	43	M8	1
6	FF LL	87	103	49	80	20	36	99	48	76	124	34	27	51	M8	2
7	FF LL	110	136	49	130	25	52	116	57	89	146	78	43	51	M8	2
5	FF LC	80	-	42	53	20	-	82	38	64	102	25	20	43	M8	1
6	FF LC	87	-	49	60	20	-	99	48	76	124	34	27	51	M8	2
7	FF LC	110	-	75	75	25	-	116	57	89	146	78	43	51	M8	2

DIMENSIONS

3-ways ball valve - FF - AF

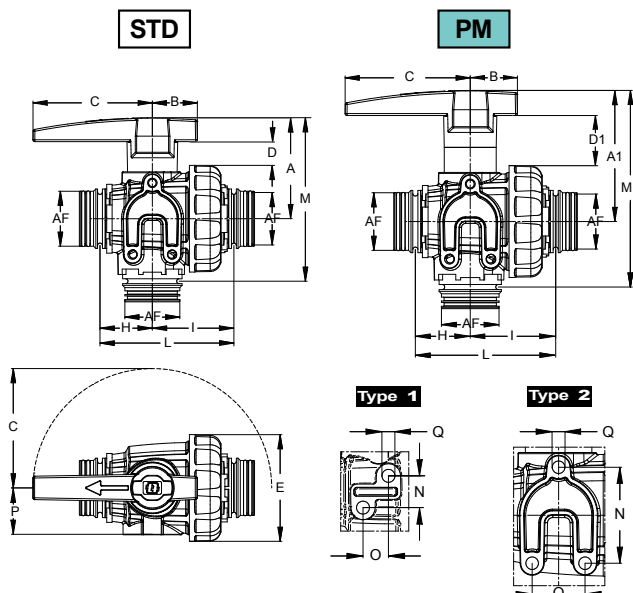

AF	Lever	A	A1	B	C	D	D1	E	H	I	L	M	M1	N	O	P	Q	Type
mm		mm	mm	mm	mm	mm	mm	mm	mm	mm	mm	mm	mm	mm	mm	mm		
3	FF LL	60	82	42	42	16	38	59	33	52	88	98	120	-	-	-	-	-
4	FF LL	73	89	42	53	20	36	69	34	60	94	115	133	25	20	37	M8	1
5	FF LL	80	97	42	80	20	36	82	38	64	102	128	145	25	20	43	M8	1
6	FF LL	87	103	49	80	20	36	99	48	76	124	149	165	34	27	51	M8	2
7	FF LL	110	136	49	130	25	52	116	57	89	146	178	204	78	43	51	M8	2
5	FF LC	80	-	42	53	20	-	82	38	64	102	128	-	25	20	43	M8	1
6	FF LC	87	-	49	60	20	-	99	48	76	124	149	-	34	27	51	M8	2
7	FF LC	110	-	75	75	25	-	116	57	89	146	178	-	78	43	51	M8	2

DIMENSIONS

3-ways ball valve - MF - AF

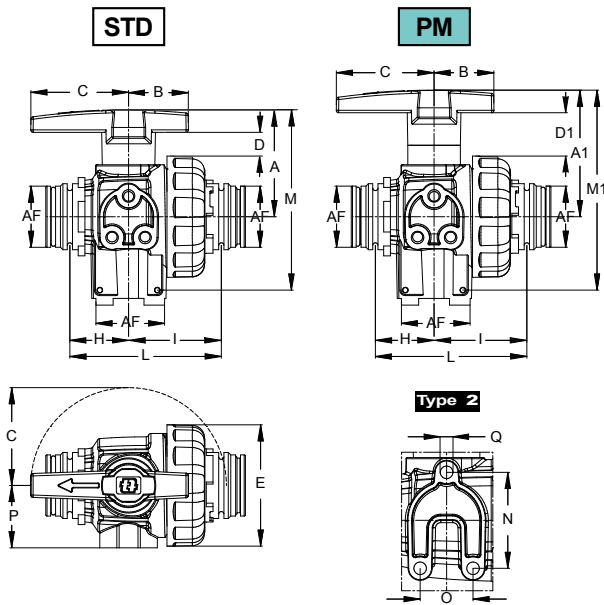

AF	Lever	A	A1	B	C	D	D1	E	H	I	L	M	M1	N	O	P	Q	Type
		mm	mm	mm	mm	mm	mm	mm	mm	mm	mm	mm	mm	mm	mm	mm	mm	
6	MF LL	87	103	49	80	20	36	99	48	76	124	147	163	34	27	51	M8	2
6	MF LL	87	103	49	80	20	36	99	48	76	124	147	163	34	27	51	M8	2

OPTIONALS

Tappi segnaletici colorati.

Indication coloured plug.

Цветные индикаторы.

Part No.	Colour	Pack
T00000020		1
T00000021		1
T00000022		1
T00000023		1
P. 196-P. 197	AF	25

w w w . g e o l i n e . i t







LEGENDA



Campo di impiego / Use / Применение

-  Per macchine a basso volume
For low-volume spraying machines
Для малообъемных опрыскивателей
-  Per macchine da diserbo
For crop sprayers
Для штанговых опрыскивателей
-  Per atomizzatori
For orchard sprayers
Для опрыскивателей
-  Componente modulare
Modular component
Модульный компонент

Caratteristiche / Features / Характеристики

-  Portata della pompa
Pump flow rate
Производительность насоса
-  Portata
Flow rate
Расход
-  Pressione d'esercizio
Operating pressure
Рабочее давление
-  Cartuccia filtrante
Filtering cartridge
Фильтрующий патрон

FEATURES

-  Prodotti non per uso alimentare
Products not for food use
Не годится для пищевых продуктов
-  60°C
MAX
Temperatura massima
Max temperature
Максимальная температура

CONVERSION TABLE



Thread	Fork coupling
3/4"	AF3
1"	AF4
1" 1/4	AF5
1" 1/2	AF6
2"	AF7
3"	AF9

FILTRI DI ASPIRAZIONE E MANDATA

SUCTION AND LINE FILTERS / ВСАСЫВАЮЩИЕ И НАПОРНЫЕ ФИЛЬТРЫ

3

Filtri di aspirazione e mandata

I filtri di aspirazione GEOLINE vengono realizzati in polipropilene, con guarnizioni in EPDM (Viton® a richiesta), particolari metallici interni in acciaio inox AISI 304, particolari metallici esterni di fissaggio in ottone, cartucce filtranti in polipropilene con reti in acciaio inox AISI 304 o in polipropilene.

I filtri di mandata GEOLINE vengono realizzati in polipropilene o nylon rinforzato con fibra di vetro, ghiere in polipropilene rinforzato con fibra di vetro, guarnizioni di tenuta in EPDM (Viton® a richiesta), particolari metallici interni in acciaio inox AISI 304, cartucce filtranti in polipropilene con reti in acciaio inox AISI 304.

Suction and line filters

GEOLINE suction filters are in polypropylene, with EPDM gaskets (Viton® on demand), internal mechanical details in AISI 304 stainless steel, external fastening brass details, polypropylene filtering cartridge with AISI 304 stainless steel or polypropylene mesh.

GEOLINE line filters are in polypropylene or fiberglass reinforced nylon, with polypropylene back nuts, EPDM seals (Viton® on demand), internal mechanical components in AISI 304 stainless steel, polypropylene filtering cartridge with AISI 304 stainless steel mesh.

Всасывающие и напорные фильтры

Всасывающие фильтры GEOLINE из полипропилена, с прокладками из EPDM (Viton® по заявке), внутренние металлические детали из нержавеющей стали AISI 304, внешние металлические крепежные детали из латуни, фильтрующие патроны из полипропилена с сетками из нержавеющей стали AISI 304 или полипропилена. Напорные фильтры GEOLINE из полипропилена или нейлона, усиленного стекловолокном, зажимные гайки из полипропилена, усиленного стекловолокном, уплотнительные прокладки из EPDM (Viton® по заявке), внутренние металлические детали из нержавеющей стали AISI 304, фильтрующие патроны из полипропилена с сетками из нержавеющей стали AISI 304.



Filtri di aspirazione per portate fino a 800 l/min.

Suction filters for flow rates up to 800 l/min
 (211,34 USGpm).

Всасывающие фильтры для расхода до
 800 литров/мин.



COLOR CODING

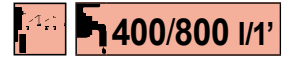

Part No.	F	l/1'	Mesh	Screen Material	Effective Area cm ²	Sq.in.	Pack
8101000	G 3 M		32	inox	505	78,3	1
8101001	G 3 M	400/800	50	inox	464	71,9	1
8101002	G 3 M		80	inox	809	78,8	1

SPARE PARTS

Part No.	Screen Mesh	Screen Material
C00100077	32	INOX
C00100078	50	
C00100079	80	

Part No.	Gasket	Material
G00001261	O-Ring	EPDM

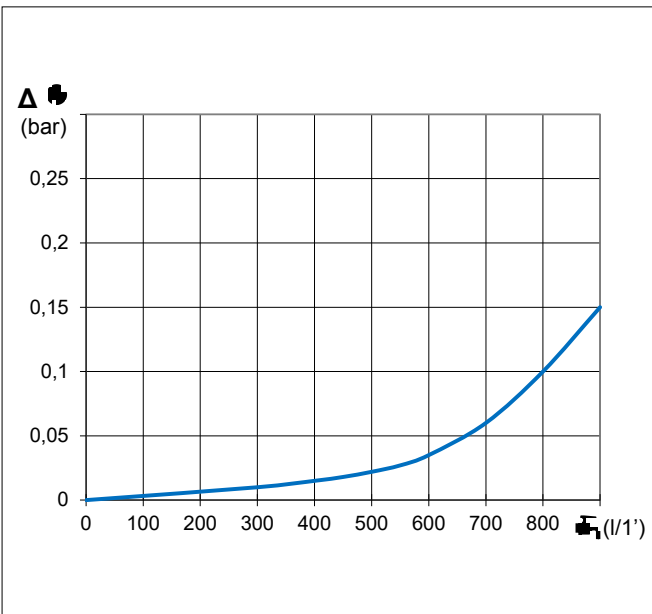

DIMENSIONS

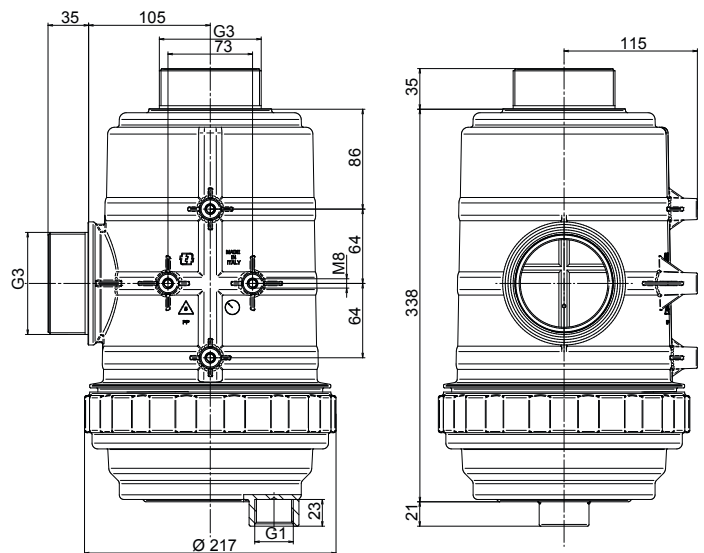

Filtri di aspirazione per portate fino a 800 l/min.

Suction filters for flow rates up to 800 l/min (211,34 USGpm).

Всасывающие фильтры для расхода до 800 литров/мин.



Part No.	F	l/min	Mesh	Screen Material	Effective Area cm ²	Sq.in.	Pack
8101003	AF9		32	inox	505	78,3	1
8101004	AF9	400/800	50	inox	464	71,9	1
8101005	AF9		80	inox	809	78,8	1

SPARE PARTS

Part No.	Screen Mesh	Screen Material
C00100077	32	INOX
C00100078	50	
C00100079	80	

Part No.	Gasket	Material
G00001261	O-Ring	EPDM

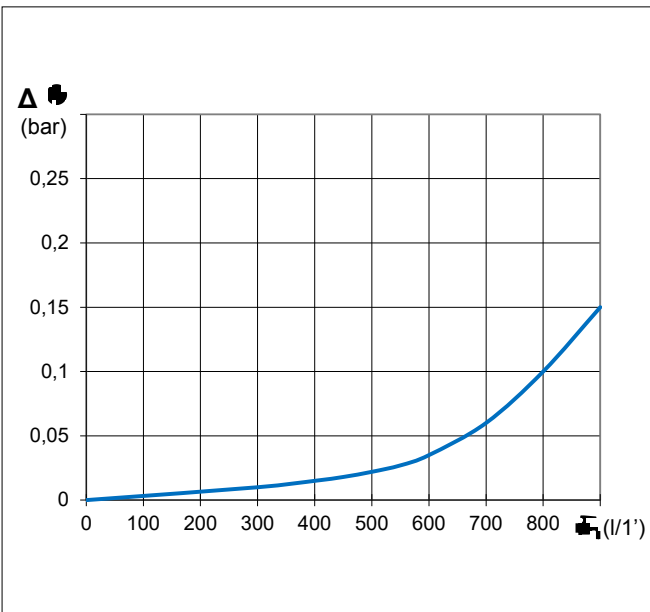

DIMENSIONS

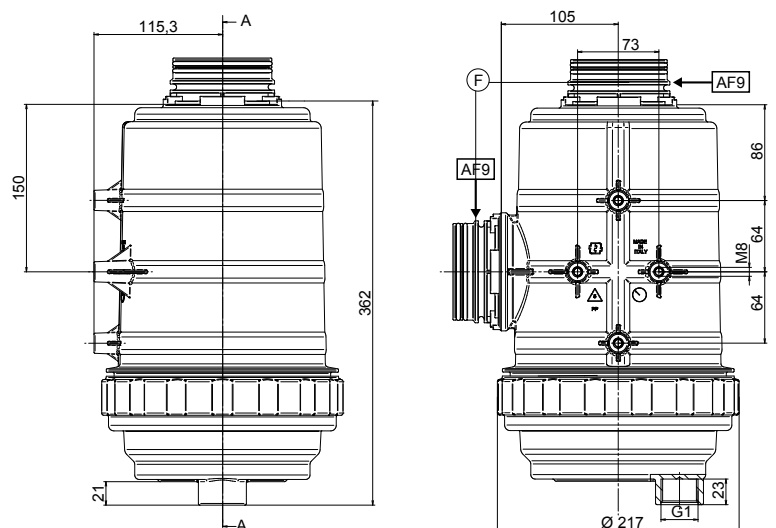

Filtri di aspirazione con valvola per portate fino a 260 l/min

Suction filters with valve for flow rates up to 260 l/min (69 USGpm)

Всасывающие фильтры с клапаном для расхода до 260 л/мин.

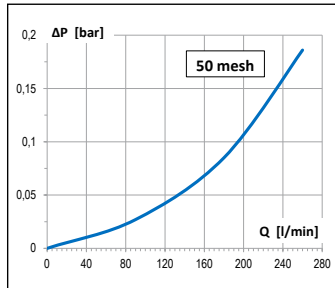
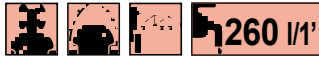

Part No.	F	H	I/1'	Mesh	Screen Material	Effective Area	Pack
		mm				cm ² Sq.in.	
8096000				32		342 53	
8096001	G 2 M	27	260	50	INOX	314 49	10
8096002				80		286 44	
8096003				32		342 53	
8096004	G 2 M	44	260	50	INOX	314 49	10
8096005				80		286 44	

SPARE PARTS

Part No.	Screen Mesh	Screen Material
C00100055	16	INOX
C00100046	32	
C00100047	50	
C00100048	80	

Part No.	Gasket Material
G00001042	O-Ring EPDM

DIMENSIONS

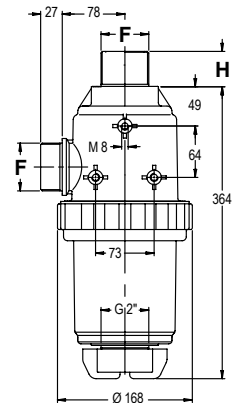

Filtri di aspirazione con valvola per portate fino a 260 l/min

Suction filters with valve for flow rates up to 260 l/min (69 USGpm)

Всасывающие фильтры с клапаном для расхода до 260 л/мин.

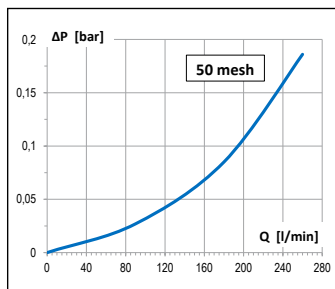

Part No.	F	I/1'	Mesh	Screen Material	Effective Area	Pack
					cm ² Sq.in.	
8096010			16		370 58	
8096011	AF7	260	32	INOX	342 53	10
8096012			50		314 49	
8096013			80		286 44	

SPARE PARTS

Part No.	Screen Mesh	Screen Material
C00100055	16	INOX
C00100046	32	
C00100047	50	
C00100048	80	

Part No.	Gasket Material
G00001042	O-Ring EPDM

DIMENSIONS

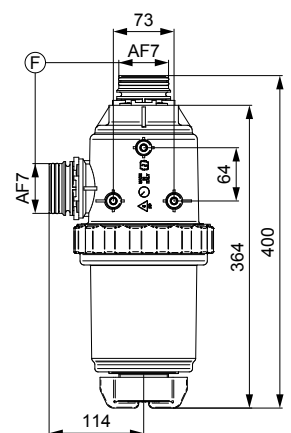

Filtri di aspirazione per portate fino a 260 l/min.

Suction filters for flow rates up to 260 l/min (69 USGpm).

Всасывающие фильтры для расхода до 260 л/мин.

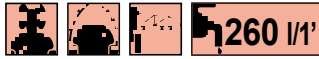

COLOR CODING

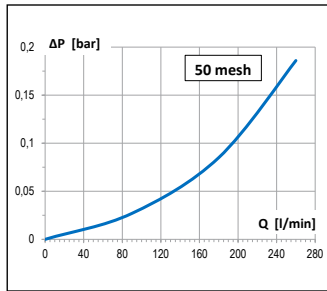

Part No.	F	H mm	I/1'	Mesh	Screen Material	Effective Area cm ²	Sq.in.	Pack
8095000				32		342	53	
8095001	G 2 M	27	260	50	INOX	314	49	10
8095002				80		286	44	
8095003				32		342	53	
8095004	G 2 M	44	260	50	INOX	314	49	10
8095005				80		286	44	

SPARE PARTS

Part No.	Screen Mesh	Screen Material
C00100055	16	INOX
C00100046	32	
C00100047	50	
C00100048	80	

Part No.	Gasket Material
G00001042	O-Ring EPDM

DIMENSIONS

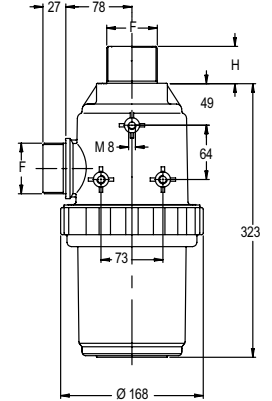

Filtri di aspirazione per portate fino a 260 l/min.

Suction filters for flow rates up to 260 l/min (69 USGpm).

Всасывающие фильтры для расхода до 260 л/мин.



COLOR CODING

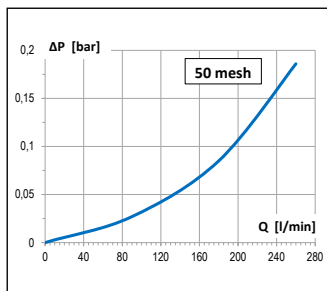

Part No.	F	I/1'	Mesh	Screen Material	Effective Area cm ²	Sq.in.	Pack
8095011			16		370	58	
8095012	AF7	260	32	INOX	342	53	10
8095013			50		314	49	
8095014			80		286	44	

SPARE PARTS

Part No.	Screen Mesh	Screen Material
C00100055	16	INOX
C00100046	32	
C00100047	50	
C00100048	80	

Part No.	Gasket Material
G00001042	O-Ring EPDM

DIMENSIONS

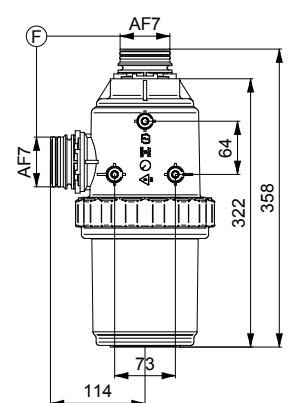

Filtri di aspirazione con valvola per portate fino a 220 l/min.

Suction filters with valve for flow rates up to 220 l/min (58 USGpm).

Всасывающие фильтры с клапаном для расхода до 220 л/мин.

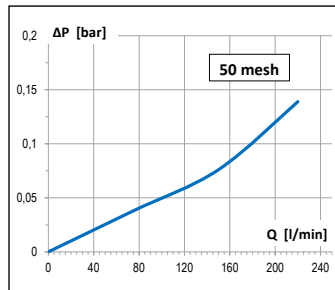

Part No.	F	H	I/I'	Mesh	Screen Material	Effective Area	Pack
		mm	I/I'			cm ² Sq.in.	
8092007				16		312 48,4	
8092000	G 2 M	27	220	32	INOX	242 37,5	10
8092001				50		222 34,5	
8092002				80		203 31,4	
8092008				16		312 48,4	
8092003	G 2 M	44	220	32	INOX	242 37,5	10
8092004				50		222 34,5	
8092005				80		203 31,4	

SPARE PARTS

Part No.	Screen Mesh	Screen Material
C00100056	16	INOX
C00100008	32	
C00100009	50	
C00100010	80	

Part No.	Gasket Material
G00001042	O-Ring EPDM

DIMENSIONS

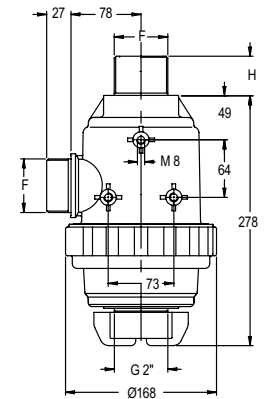

Filtri di aspirazione con valvola per portate fino a 220 l/min.

Suction filters with valve for flow rates up to 220 l/min (58 USGpm).

Всасывающие фильтры с клапаном для расхода до 220 л/мин.

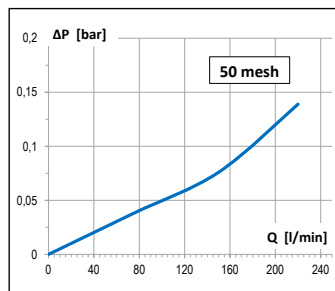

Part No.	F	I/I'	Mesh	Screen Material	Effective Area	Pack
					cm ² Sq.in.	
8092015			16		312 48,4	
8092016	AF7	220	32	INOX	242 37,5	10
8092017			50		222 34,5	
8092018			80		203 31,4	

SPARE PARTS

Part No.	Screen Mesh	Screen Material
C00100056	16	INOX
C00100008	32	
C00100009	50	
C00100010	80	

Part No.	Gasket Material
G00001042	O-Ring EPDM

DIMENSIONS

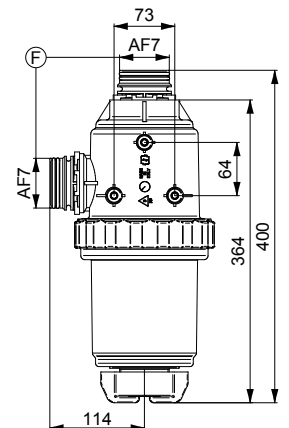

Filtri di aspirazione per portate fino a 220 l/min.

Suction filters for flow rates up to 220 l/min (58 USGpm).

Всасывающие фильтры для расхода до 220 л/мин.

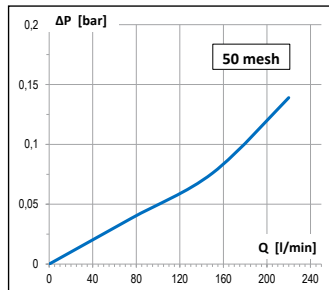

Part No.	F	H mm	I/I'	Mesh	Screen Material	Effective Area cm ²	Sq.in.	Pack
8091000				32		242	37,5	
8091001	G 2 M	27	220	50	INOX	222	34,5	10
8091002				80		203	31,4	
8091007				16		312	48,4	
8091003	G 2 M	44	220	32	INOX	242	37,5	10
8091004				50		222	34,5	
8091005				80		203	31,4	

SPARE PARTS

Part No.	Screen Mesh	Screen Material
C00100056	16	INOX
C00100008	32	
C00100009	50	
C00100010	80	

Part No.	Gasket Material
G00001042	O-Ring EPDM

DIMENSIONS

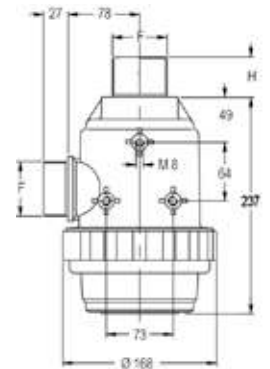

Filtri di aspirazione per portate fino a 220 l/min.

Suction filters for flow rates up to 220 l/min (58 USGpm).

Всасывающие фильтры для расхода до 220 л/мин.

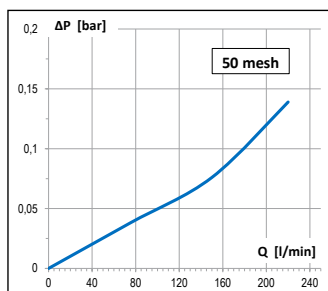

Part No.	F	I/I'	Mesh	Screen Material	Effective Area cm ²	Sq.in.	Pack
8091013			16		312	48,4	
8091014	AF7	220	32	INOX	242	37,5	10
8091015			50		222	34,5	
8091016			80		203	31,4	

SPARE PARTS

Part No.	Screen Mesh	Screen Material
C00100056	16	INOX
C00100008	32	
C00100009	50	
C00100010	80	

Part No.	Gasket Material
G00001042	O-Ring EPDM

DIMENSIONS

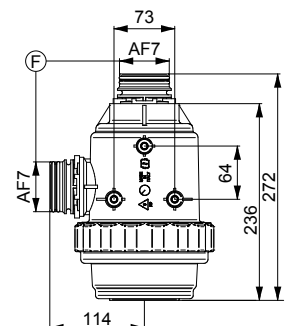

Filtri di aspirazione con valvola per portate fino a 180 l/min.

Suction filters with valve for flow rates up to 180 l/min (47 USGpm).

Всасывающие фильтры с клапаном для расхода до 180 л/мин.



COLOR CODING

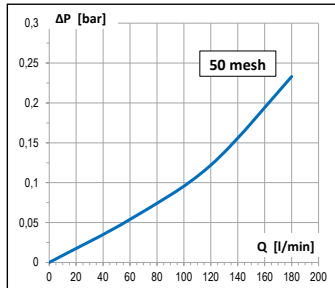

Part No.	F	H	Mesh	Screen Material	Effective Area	Pack
	mm	l/1'			cm ² Sq.in.	
8088000			32		242 37,5	
8088001	G 1½ M	24	180	50	INOX	222 34,5 15
8088002			80		203 31,4	
8088003			32		242 37,5	
8088004	G 1½ M	44	180	50	INOX	222 34,5 15
8088005			80		203 31,4	

SPARE PARTS

Part No.	Screen Mesh	Screen Material
C00100056	16	INOX
C00100008	32	
C00100009	50	
C00100010	80	

Part No.	Gasket Material
G00001042	O-Ring EPDM

DIMENSIONS

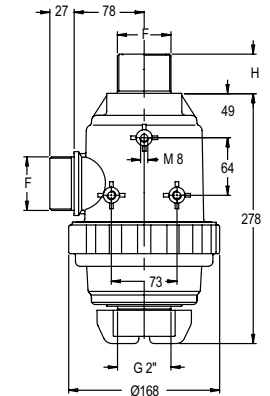

Filtri di aspirazione con valvola per portate fino a 180 l/min.

Suction filters with valve for flow rates up to 180 l/min (47 USGpm).

Всасывающие фильтры с клапаном для расхода до 180 л/мин.



COLOR CODING

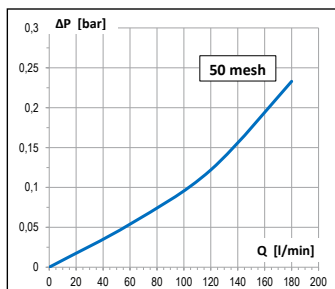

Part No.	F	Mesh	Screen Material	Effective Area	Pack
	l/1'			cm ² Sq.in.	
8088007		16		261 40,5	
8088008	AF6	180	32	INOX	242 37,5 15
8088009		50		222 34,5	
8088010		80		203 31,4	

SPARE PARTS

Part No.	Screen Mesh	Screen Material
C00100056	16	INOX
C00100008	32	
C00100009	50	
C00100010	80	

Part No.	Gasket Material
G00001042	O-Ring EPDM

DIMENSIONS

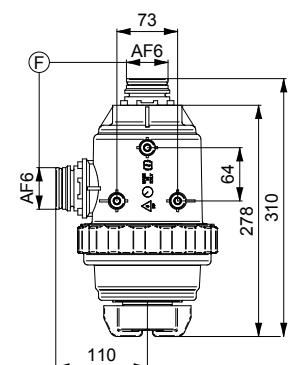

Filtri di aspirazione per portate fino a 180 l/min.

Suction filters for flow rates up to 180 l/min (47 USGpm).

Всасывающие фильтры для расхода до 180 л/мин.



COLOR CODING

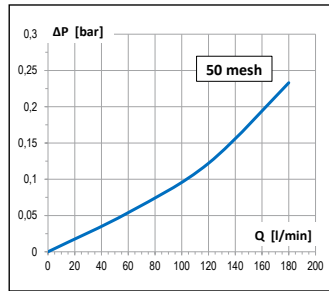

Part No.	F	H	Mesh	Screen Material	Effective Area	Pack
		mm / I/1'			cm ² / Sq.in.	
8087000			32		242 / 37,5	
8087001	G 1½ M	24 / 180	50	INOX	222 / 34,5	15
8087002			80		203 / 31,4	
8087003			32		242 / 37,5	
8087004	G 1½ M	44 / 180	50	INOX	222 / 34,5	15
8087005			80		203 / 31,4	

SPARE PARTS

Part No.	Screen Mesh	Screen Material
C00100056	16	INOX
C00100008	32	
C00100009	50	
C00100010	80	

Part No.	Gasket Material
G00001042	O-Ring EPDM

DIMENSIONS

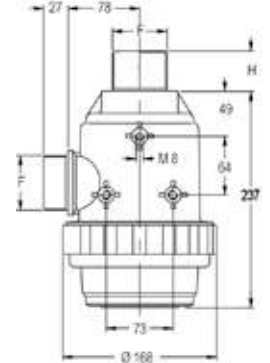

Filtri di aspirazione per portate fino a 180 l/min.

Suction filters for flow rates up to 180 l/min (47 USGpm).

Всасывающие фильтры для расхода до 180 л/мин.



COLOR CODING

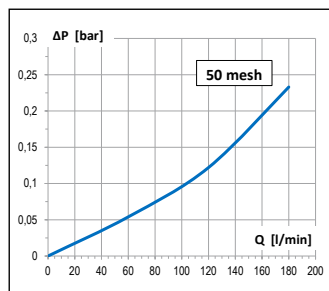

Part No.	F	Mesh	Screen Material	Effective Area	Pack
				cm ² / Sq.in.	
8087009		16		261 / 40,5	
8087010	AF6	180	32	242 / 37,5	15
8087011		50	INOX	222 / 34,5	
8087012		80		203 / 31,4	

SPARE PARTS

Part No.	Screen Mesh	Screen Material
C00100056	16	INOX
C00100008	32	
C00100009	50	
C00100010	80	

Part No.	Gasket Material
G00001042	O-Ring EPDM

DIMENSIONS

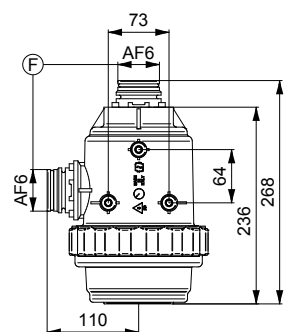

Filtri di aspirazione con valvola per portate fino a 150 l/min.

Suction filters with valve for flow rates up to 150 l/min (40 USGpm).

Всасывающие фильтры с клапаном для расхода до 150 л/мин.



COLOR CODING

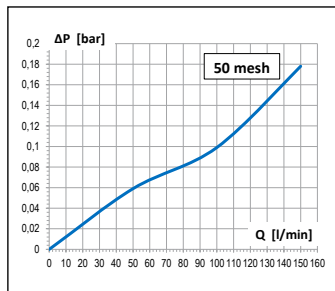

Part No.	F	H	I/1'	Mesh	Screen Material	Effective Area	Pack
		mm				cm ² Sq.in.	
8082010				16		177,8 27,6	
8082000	G 1½ M	24	150	32	INOX	138 21,4	
8082001				50		126 19,5	20
8082002				80		115 17,8	
8082006				16		177,8 27,6	
8082003				32		138 21,4	
8082004	G 1½ M	40	150	50	INOX	126 19,5	20
8082005				80		115 17,8	
8082015				100		110 17,1	

SPARE PARTS

Part No.	Screen Mesh	Screen Material
C00100069	16	
C00100011	32	
C00100012	50	INOX
C00100013	80	
C00100076	100	

Part No.	Gasket Material
G00001040	O-Ring EPDM

DIMENSIONS

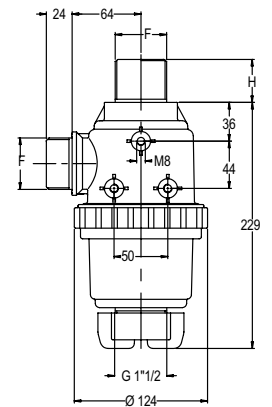

Filtri di aspirazione con valvola per portate fino a 150 l/min.

Suction filters with valve for flow rates up to 150 l/min (40 USGpm).

Всасывающие фильтры с клапаном для расхода до 150 л/мин.



COLOR CODING

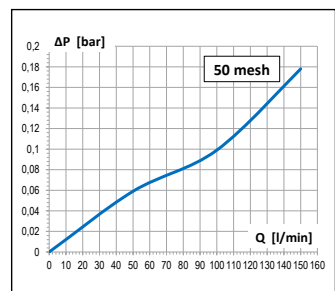

Part No.	F	I/1'	Mesh	Screen Material	Effective Area	Pack
					cm ² Sq.in.	
8082016			16		177,8 27,6	
8082017			32		138 21,4	
8082018	AF6	150	50	INOX	126 19,5	20
8082019			80		115 17,8	
8082020			100		110 17,1	

SPARE PARTS

Part No.	Screen Mesh	Screen Material
C00100069	16	
C00100011	32	
C00100012	50	INOX
C00100013	80	
C00100076	100	

Part No.	Gasket Material
G00001040	O-Ring EPDM

DIMENSIONS

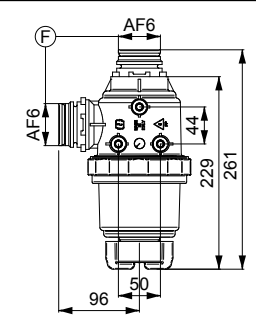

Filtri di aspirazione per portate fino a 150 l/min.

Suction filters for flow rates up to 150 l/min (40 USGpm).

Всасывающие фильтры для расхода до 150 л/мин.



COLOR CODING

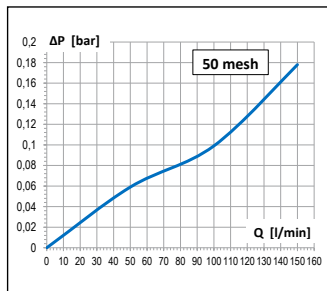

Part No.	F	H	I/1'	Mesh	Screen Material	Effective Area	Pack
		mm				cm ² Sq.in.	
8081000				32		138 21,4	
8081001	G 1½ M	27	150	50	INOX	126 19,5	20
8081002				80		115 17,8	
8081003				32		138 21,4	
8081004	G 1½ M	40	150	50	INOX	126 19,5	20
8081005				80		115 17,8	

SPARE PARTS

Part No.	Screen Mesh	Screen Material
C00100069	16	INOX
C00100011	32	
C00100012	50	
C00100013	80	

Part No.	Gasket Material
G00001040	O-Ring EPDM

DIMENSIONS

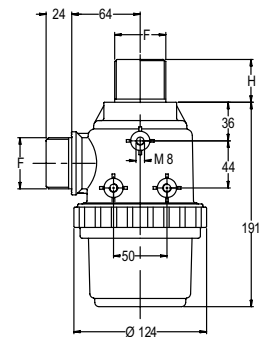

Filtri di aspirazione per portate fino a 150 l/min.

Suction filters for flow rates up to 150 l/min (40 USGpm).

Всасывающие фильтры для расхода до 150 л/мин.



COLOR CODING

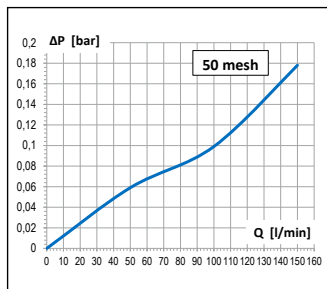

Part No.	F	I/1'	Mesh	Screen Material	Effective Area	Pack
					cm ² Sq.in.	
8081012			16		177,8 27,6	
8081013			32		138 21,4	
8081014	AF6	150	50	INOX	126 19,5	20
8081015			80		115 17,8	
8081016			100		110 17,1	

SPARE PARTS

Part No.	Screen Mesh	Screen Material
C00100069	16	INOX
C00100011	32	
C00100012	50	
C00100013	80	
C00100076	100	

Part No.	Gasket Material
G00001040	O-Ring EPDM

DIMENSIONS

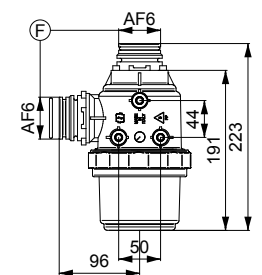

Filtri di aspirazione con valvola per portate fino a 150 l/min.

Suction filters with valve for flow rates up to 150 l/min (40 USGpm).

Всасывающие фильтры с клапаном для расхода до 150 л/мин.

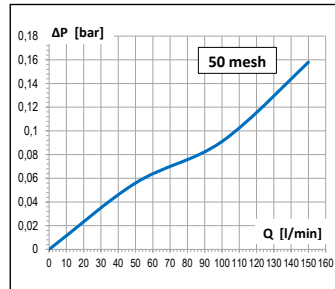

Part No.	F	H	Mesh	Screen Material	Effective Area	Pack
		mm			cm ² Sq.in.	
8080000			32		86 13,3	
8080001	G 1½ M	24	50	INOX	79 12,3	20
8080002			80		72 11,2	
8080003			32		86 13,3	
8080004	G 1½ M	40	50	INOX	79 12,3	20
8080005			80		72 11,2	

SPARE PARTS

Part No.	Screen Mesh	Screen Material
C00100017	32	
C00100018	50	INOX
C00100019	80	

Part No.	Gasket Material
G00001040	O-Ring EPDM

DIMENSIONS

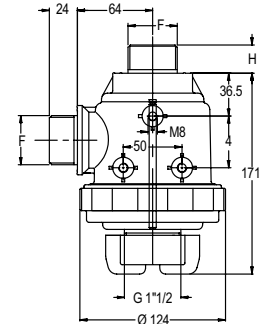

Filtri di aspirazione con valvola per portate fino a 120 l/min.

Suction filters with valve for flow rates up to 120 l/min (32 USGpm).

Всасывающие фильтры с клапаном для расхода до 120 л/мин.

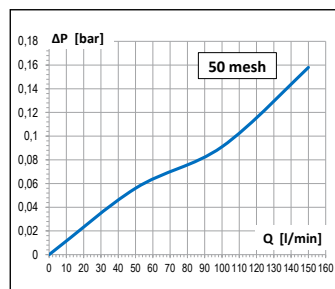

Part No.	F	Mesh	Screen Material	Effective Area	Pack
	l/1'			cm ² Sq.in.	
8080007		32		86 13,3	
8080008	AF6	50	INOX	79 12,3	20
8080009		80		72 11,2	
8080010		100		76 12	

SPARE PARTS

Part No.	Screen Mesh	Screen Material
C00100017	32	
C00100018	50	INOX
C00100019	80	
C00100050	100	

Part No.	Gasket Material
G00001040	O-Ring EPDM

DIMENSIONS

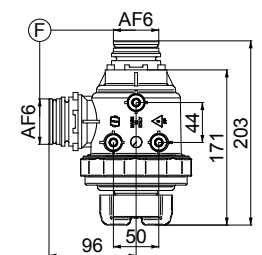

Filtri di aspirazione per portate fino a 150 l/min.

Suction filters for flow rates up to 150 l/min (40 USGpm).

Всасывающие фильтры для расхода до 150 л/мин.

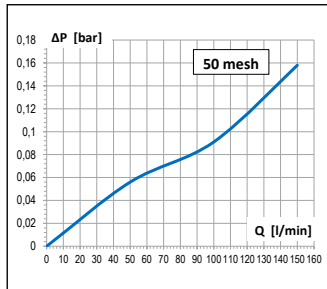

Part No.	F	H	Mesh	Screen Material	Effective Area	Pack
		mm	l/1'		cm ² Sq.in.	
8079000			32		86 13,3	
8079001	G 1½ M	24	50	INOX	79 12,3	20
8079002			80		72 11,2	
8079003			32		86 13,3	
8079004	G 1½ M	40	50	INOX	79 12,3	20
8079005			80		72 11,2	

SPARE PARTS

Part No.	Screen Mesh	Screen Material
C00100017	32	INOX
C00100018	50	
C00100019	80	

Part No.	Gasket Material
G00001040	O-Ring EPDM

DIMENSIONS

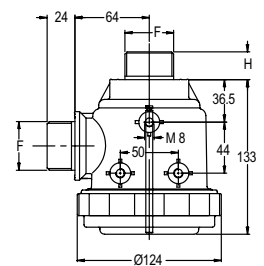

Filtri di aspirazione per portate fino a 120 l/min.

Suction filters for flow rates up to 120 l/min (32 USGpm).

Всасывающие фильтры для расхода до 120 л/мин.

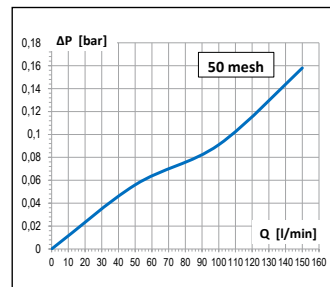

Part No.	F	Mesh	Screen Material	Effective Area	Pack
		l/1'		cm ² Sq.in.	
8079006		32		86 13,3	
8079007	AF6	120	50	79 12,3	20
8079008		80	INOX	72 11,2	
8079009		100		76 12	

SPARE PARTS

Part No.	Screen Mesh	Screen Material
C00100017	32	INOX
C00100018	50	
C00100019	80	
C00100050	100	

Part No.	Gasket Material
G00001040	O-Ring EPDM

DIMENSIONS

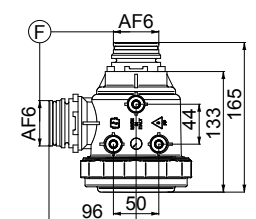

Filtri di aspirazione con valvola per portate fino a 120 l/min.

Suction filters with valve for flow rates up to 120 l/min (32 USGpm).

Всасывающие фильтры с клапаном для расхода до 120 л/мин.



COLOR CODING

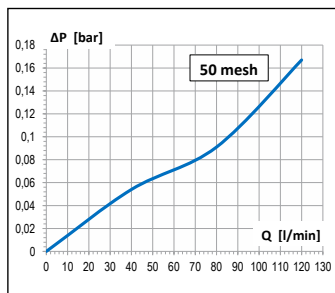

Part No.	F	H	I/1'	Mesh	Screen Material	Effective Area		Pack
						cm ²	Sq.in.	
8078000				32		86	13,3	
8078001	G 1¼ M	24	120	50	INOX	79	12,3	20
8078002				80		72	11,2	
8078006				100		76	12	
8078003				32		86	13,3	
8078004	G 1¼ M	40	120	50	INOX	79	12,3	20
8078005				80		72	11,2	
8078007				100		76	12	

SPARE PARTS

Part No.	Screen Mesh	Screen Material
C00100018	50	
C00100019	80	
C00100050	100	

Part No.	Gasket Material
G00001040	O-Ring EPDM

DIMENSIONS

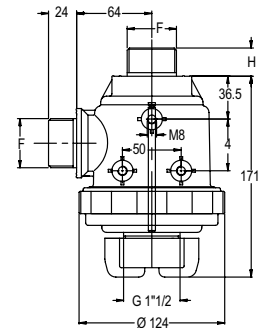

Filtri di aspirazione per portate fino a 120 l/min.

Suction filters for flow rates up to 120 l/min (32 USGpm).

Всасывающие фильтры для расхода до 120 л/мин.



COLOR CODING

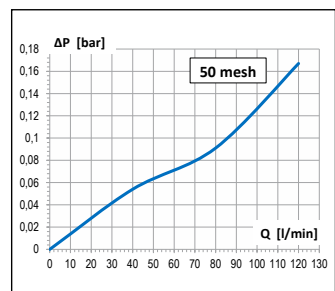

Part No.	F	H	I/1'	Mesh	Screen Material	Effective Area		Pack
						cm ²	Sq.in.	
8077000				32		86	13,3	
8077001	G 1¼ M	24	120	50	INOX	79	12,3	20
8077002				80		72	11,2	
8077006				100		76	12	
8077003				32		86	13,3	
8077004	G 1¼ M	40	120	50	INOX	79	12,3	20
8077005				80		72	11,2	
8077007				100		76	12	

SPARE PARTS

Part No.	Screen Mesh	Screen Material
C00100018	50	
C00100019	80	
C00100050	100	

Part No.	Gasket Material
G00001040	O-Ring EPDM

DIMENSIONS

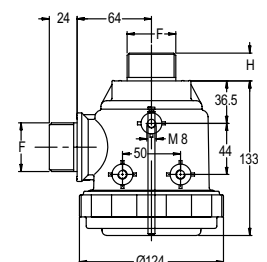

Filtri di aspirazione con valvola per portate fino a 120 l/min.

Suction filters with valve for flow rates up to 120 l/min (40 USGpm).

Всасывающие фильтры с клапаном для расхода до 120 л/мин.



COLOR CODING

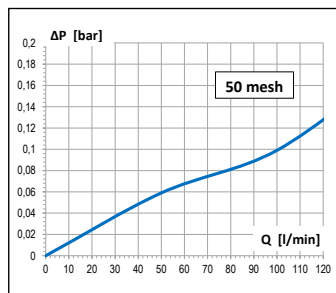

Part No.	F	H	I/1'	Mesh	Screen Material	Effective Area	cm ²	Sq.in.	Pack
8076007				16		177,8	27,6		
8076000	G 1¼ M	24	120	32	INOX	138	21,4	20	
8076001				50		126	19,5		
8076002				80		115	17,8		
8076006				16		177,8	27,6		
8076003	G 1¼ M	40	120	32	INOX	138	21,4	20	
8076004				50		126	19,5		
8076005				80		115	17,8		

SPARE PARTS

Part No.	Screen Mesh	Screen Material
C00100069	16	INOX
C00100011	32	
C00100012	50	
C00100013	80	

Part No.	Gasket Material
G00001040	O-Ring EPDM

DIMENSIONS

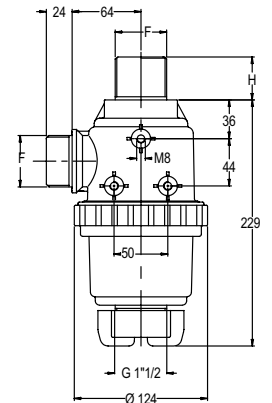

Filtri di aspirazione per portate fino a 120 l/min.

Suction filters for flow rates up to 120 l/min (32 USGpm).

Всасывающие фильтры для расхода до 120 л/мин.



COLOR CODING

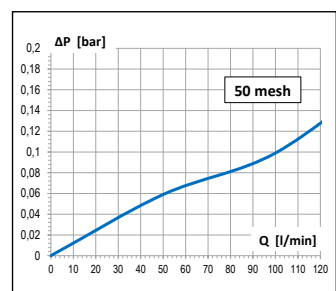

Part No.	F	H	I/1'	Mesh	Screen Material	Effective Area	cm ²	Sq.in.	Pack
8075006				16		177,8	27,6		
8075000	G 1¼ M	27	120	32	INOX	138	21,4	20	
8075001				50		126	19,5		
8075002				80		115	17,8		
8075007				16		177,8	27,6		
8075003	G 1¼ M	40	120	32	INOX	138	21,4	20	
8075004				50		126	19,5		
8075005				80		115	17,8		

SPARE PARTS

Part No.	Screen Mesh	Screen Material
C00100069	16	INOX
C00100011	32	
C00100012	50	
C00100013	80	

Part No.	Gasket Material
G00001040	O-Ring EPDM

DIMENSIONS

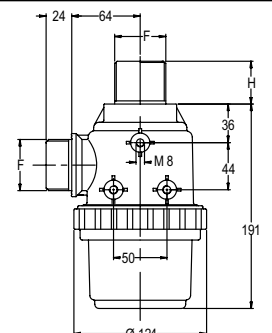

Filtri di aspirazione per portate fino a 100 l/min.

Suction filters for flow rates up to 100 l/min (26 USGpm).

Всасывающие фильтры для расхода до 100 л/мин.

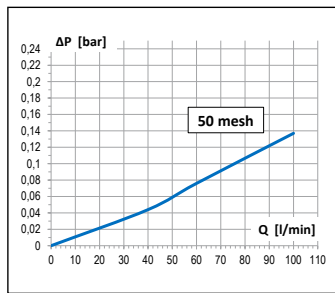
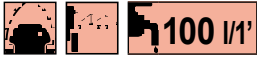

Part No.	F	H	I/1'	Mesh	Screen Material	Effective Area	Pack
		mm				cm ² Sq.in.	
8074000				32	INOX	105 16,3	
8074001				50	INOX	97 15	
8074002	G 1¼ M	24	100	18	PP	90 14	20
8074003				32	PP	69 10,7	
8074008				100	INOX	94 14,5	
8074004				32	INOX	105 16,3	
8074005				50	INOX	97 15	
8074006	G 1¼ M	40	100	18	PP	90 14	20
8074007				32	PP	69 10,7	
8074009				100	INOX	94 14,5	

SPARE PARTS

Part No.	Screen Mesh	Screen Material
C00100020	32	INOX
C00100021	50	
C00100036	100	
C00100022	18	PP
C00100023	32	

Part No.	Gasket Material
G00001034	O-Ring EPDM

DIMENSIONS

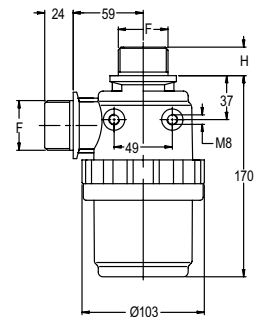

Filtri di aspirazione per portate fino a 150 l/min.

Suction filters for flow rates up to 150 l/min (40 USGpm).

Всасывающие фильтры для расхода до 150 л/мин.

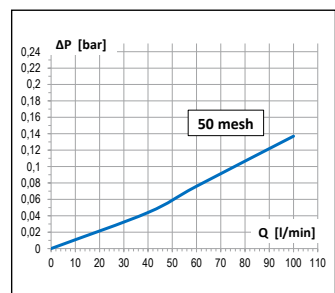

Part No.	F	I/1'	Mesh	Screen Material	Effective Area	Pack
					cm ² Sq.in.	
8074017			18	PP	90 14	
8074018			32	PP	69 10,7	
8074014	AF5	100	32	INOX	105 16,3	20
8074015			50	INOX	97 15	
8074016			100	INOX	94 14,5	

SPARE PARTS

Part No.	Screen Mesh	Screen Material
C00100020	32	INOX
C00100021	50	
C00100036	100	
C00100022	18	PP
C00100023	32	

Part No.	Gasket Material
G00001034	O-Ring EPDM

DIMENSIONS

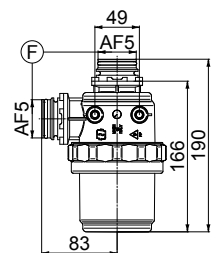

OPTIONALS

AF FORK FITTINGS Pag. 196 - 197

Filtri di aspirazione per portate fino a 60 l/min.

Suction filters for flow rates up to 60 l/min (16 USGpm).

Всасывающие фильтры для расхода до 60 л/мин.

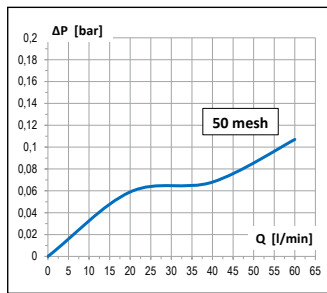
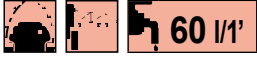

Part No.	F	H	I/1'	Mesh	Screen Material	Effective Area	Pack
		mm				cm ² Sq.in.	
8072000				32	INOX	66 10,3	
8072001	G 1¼ M	24	60	50	INOX	61 9,4	20
8072002				18	PP	56 8,7	
8072003				32	PP	43 6,7	
8072004				32	INOX	66 10,3	
8072005	G 1¼ M	40	60	50	INOX	61 9,4	20
8072006				18	PP	56 8,7	
8072007				32	PP	43 6,7	

SPARE PARTS

Part No.	Screen Mesh	Screen Material
C00100024	32	INOX
C00100025	50	
C00100026	18	PP
C00100027	32	

Part No.	Gasket Material
G00001034	O-Ring EPDM

DIMENSIONS

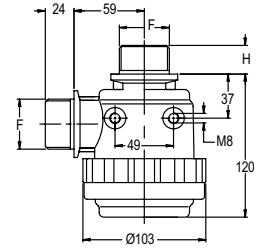

Filtri di aspirazione per portate fino a 60 l/min.

Suction filters for flow rates up to 60 l/min (16 USGpm).

Всасывающие фильтры для расхода до 60 л/мин.

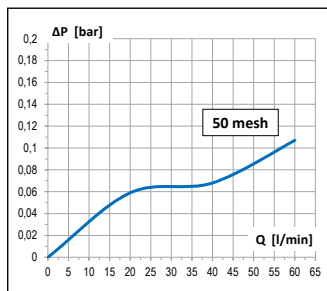

Part No.	F	I/1'	Mesh	Screen Material	Effective Area	Pack
					cm ² Sq.in.	
8072010			18	PP	56 8,7	
8072011	AF5	60	32	PP	43 6,7	20
8072008			32	INOX	66 10,3	
8072009			50	INOX	61 9,4	

SPARE PARTS

Part No.	Screen Mesh	Screen Material
C00100024	32	INOX
C00100025	50	
C00100026	18	PP
C00100027	32	

Part No.	Gasket Material
G00001034	O-Ring EPDM

DIMENSIONS

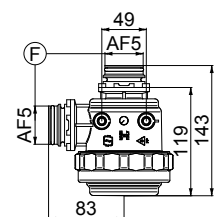

OPTIONALS

AF FORK FITTINGS Pag. 196 - 197

Filtri di mandata per pressioni di esercizio fino a 15 bar. *Line filters for pressures up to 15 bar (220 PSI).* *Напорные фильтры для рабочего давления до 15 бар.*

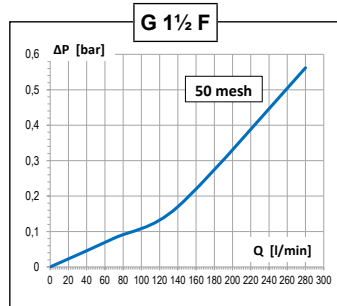
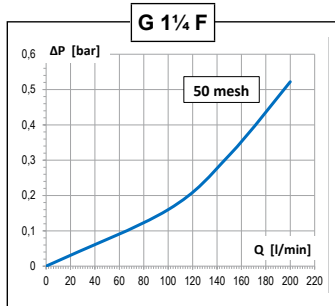
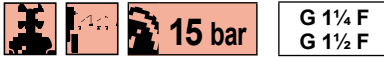

Part No.	F	I/1'	bar	Mesh	Screen Material	Effective Area		Pack
						cm ²	Sq.in.	
NEW 8121046				16		148,8	23,1	
8121000				32		116	18	
8121001	G 1 1/4 F	200	15	50	INOX	106	16,4	5
8121002				80		97	15	
8121003				100		103	16	
NEW 8121026				16		148,8	23,1	
8121004				32		116	18	
8121005	G 1 1/2 F	280	15	50	INOX	106	16,4	5
8121006				80		97	15	
8121007				100		103	16	

SPARE PARTS

Part No.	Screen Mesh	Screen Material
C00100070	16	
C00100032	32	
C00100033	50	INOX
C00100034	80	
C00100035	100	

Part No.	Gasket Material
G00001046	O-Ring EPDM

DIMENSIONS

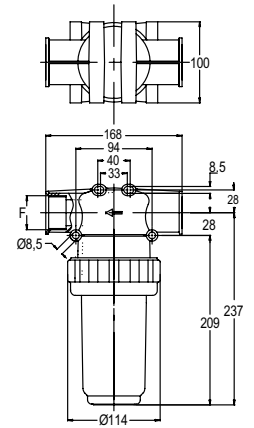

Filtri di mandata per pressioni di esercizio fino a 15 bar.

Line filters for pressures up to 15 bar (220 PSI).

Напорные фильтры для рабочего давления до 15 бар.

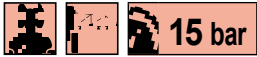

COLOR CODING

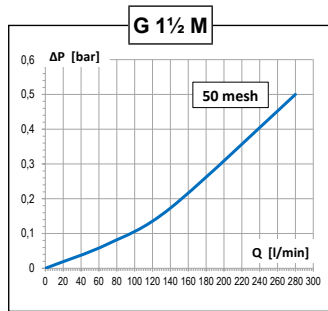
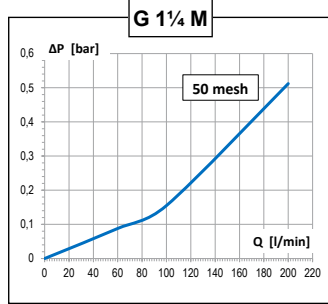

Part No.	F	I/1'	bar	Mesh	Screen Material	Effective Area cm ² Sq.in.	Pack
8127000				32		116 18	
8127001	G 1 1/4 M	200	15	50	INOX	106 16,4	5
8127002				80		97 15	
8127003				100		103 16	
8127004				32		116 18	
8127005	G 1 1/2 M	280	15	50	INOX	106 16,4	5
8127006				80		97 15	
8127007				100		103 16	

SPARE PARTS

Part No.	Screen Mesh	Screen Material
C00100032	32	INOX
C00100033	50	
C00100034	80	
C00100035	100	

Part No.	Gasket Material
G00001046	O-Ring EPDM

DIMENSIONS

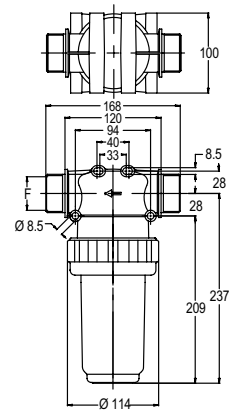

Filtri di mandata per pressioni di esercizio fino a 15 bar.

Line filters for pressures up to 15 bar (220 PSI).

Напорные фильтры для рабочего давления до 15 бар.



COLOR CODING

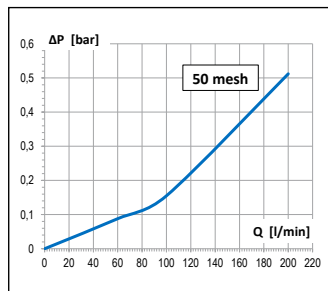

Part No.	F	I/1'	Mesh	Screen Material	Effective Area cm ² Sq.in.	Pack
8127020			32		116 18	
8127021	AF5	280	50	INOX	106 16,4	5
8127022			80		97 15	
8127023			100		103 16	

SPARE PARTS

Part No.	Screen Mesh	Screen Material
C00100032	32	INOX
C00100033	50	
C00100034	80	
C00100035	100	

Part No.	Gasket Material
G00001046	O-Ring EPDM

DIMENSIONS

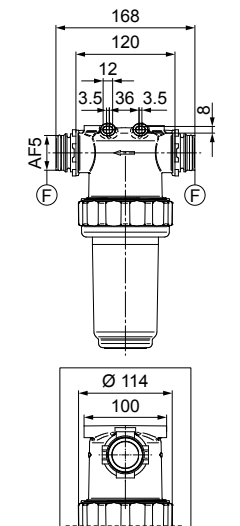

OPTIONALS

AF5 FORK FITTINGS Pag. 196 - 197

Filtri di mandata per pressioni di esercizio fino a 20 bar.

Line filters for pressures up to 20 bar (290 PSI).

Напорные фильтры для рабочего давления до 20 бар.



SPARE PARTS

Part No.	Screen Mesh	Screen Material
C00100083	16	INOX
C00100000	32	
C00100001	50	
C00100002	80	
C00100003	100	

Part No.	Gasket Material
G00001024	O-Ring EPDM

DIMENSIONS

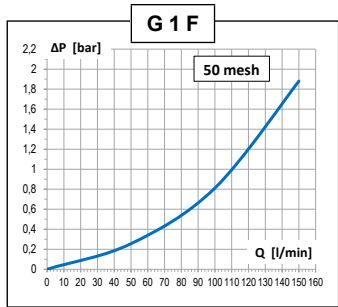
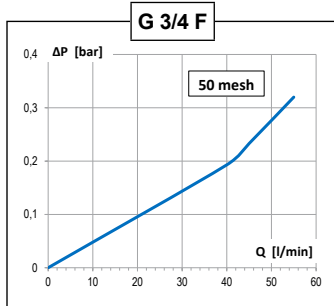
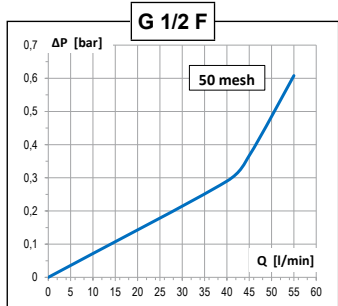
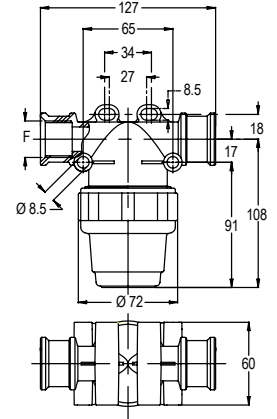

NEW

NEW

NEW

Part No.	F	l/1'	bar	Mesh	Screen Material	Effective Area cm ²	Sq.in.	Pack
8105089				16		49,1	7,6	
8105000				32		26	4	
8105001	G 1/2 F	80	20	50	INOX	24	3,7	25
8105002				80		22	3,4	
8105003				100		23	3,6	
8105090				16		49,1	7,6	
8105004				32		26	4	
8105005	G 3/4 F	100	20	50	INOX	24	3,7	25
8105006				80		22	3,4	
8105007				100		23	3,6	
8105091				16		33,9	5,3	
8105008				32		38	5,9	
8105009	G 1 F	150	20	50	INOX	35	5,4	25
8105010				80		32	5	
8105011				100		34	5,3	

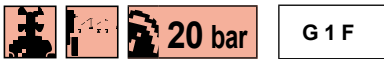

SPARE PARTS

Part No.	Screen Mesh	Screen Material
C00100084	16	INOX
C00100004	32	
C00100005	50	
C00100006	80	
C00100007	100	

Part No.	Gasket Material
G00001024	O-Ring EPDM

DIMENSIONS

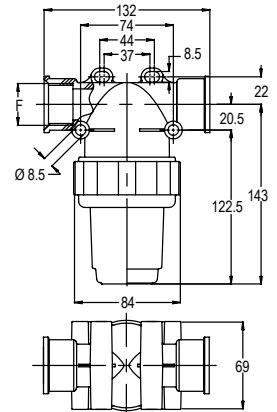

Filtri di mandata per pressioni di esercizio fino a 20 bar.

Line filters for pressures up to 20 bar (290 PSI).

Напорные фильтры для рабочего давления до 20 бар.

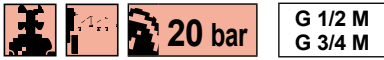

20 bar

G 1/2 M
G 3/4 M



COLOR CODING



Part No.	F	I/1'	bar	Mesh	Screen Material	Effective Area cm ²	Sq.in.	Pack
8110000				32		26	4	
8110001	G 1/2 M	80	20	50	INOX	24	3,7	25
8110002				80		22	3,4	
8110003				100		23	3,6	
8110004				32		26	4	
8110005	G 3/4 M	100	20	50	INOX	24	3,7	25
8110006				80		22	3,4	
8110007				100		23	3,6	

SPARE PARTS

Part No.	Screen Mesh	Screen Material
C00100000	32	
C00100001	50	INOX
C00100002	80	
C00100003	100	

Part No.	Gasket Material
G00001024	O-Ring EPDM

DIMENSIONS

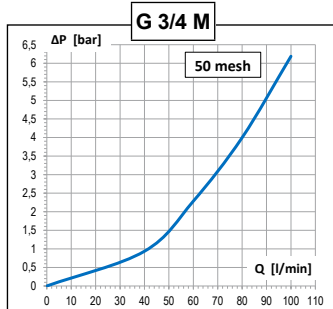
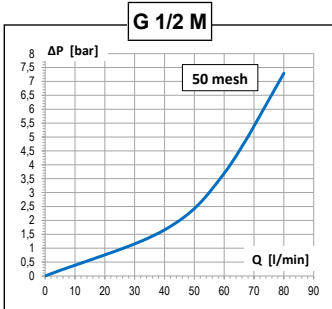
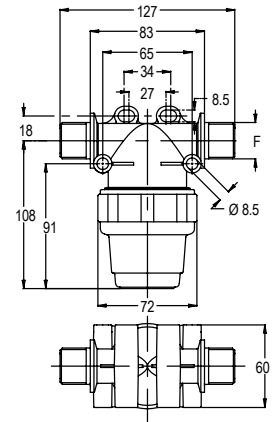

Filtri di mandata per pressioni di esercizio fino a 15 bar.

Line filters for pressures up to 15 bar (220 PSI).

Напорные фильтры для рабочего давления до 15 бар.



15 bar



COLOR CODING



Part No.	F	I/1'	Mesh	Screen Material	Effective Area cm ²	Sq.in.	Pack
8110022			32		26	4	
8110023	AF3	100	50	INOX	24	3,7	25
8110024			80		22	3,4	
8110025			100		23	3,6	

SPARE PARTS

Part No.	Screen Mesh	Screen Material
C00100000	32	
C00100001	50	INOX
C00100002	80	
C00100003	100	

Part No.	Gasket Material
G00001024	O-Ring EPDM

DIMENSIONS

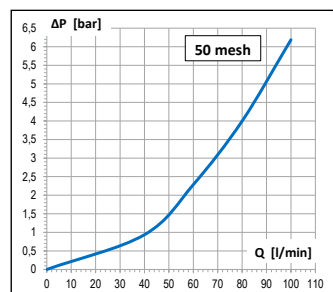
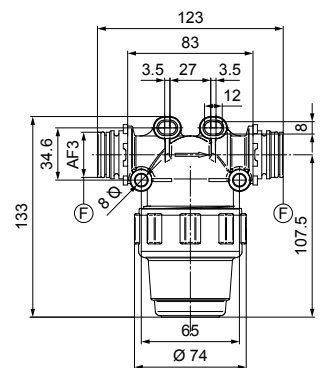

OPTIONALS

AF3 FORK FITTINGS Pag. 196 - 197

Filtri di mandata per pressioni di esercizio fino a 20 bar.

Line filters for pressures up to 20 bar (290 PSI).

Напорные фильтры для рабочего давления до 20 бар.

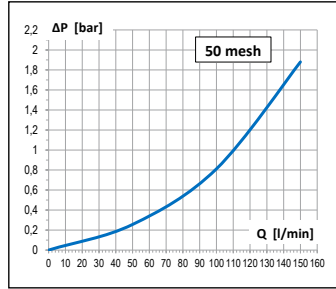
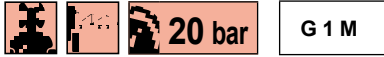

Part No.	F	I/1'	bar	Mesh	Screen Material	Effective Area cm ²	Sq.in.	Pack
8110008				32		38	5,9	
8110009	G 1 M	150	20	50	INOX	35	5,4	25
8110010				80		32	5	
8110011				100		34	5,3	

SPARE PARTS

Part No.	Screen Mesh	Screen Material
C00100004	32	INOX
C00100005	50	INOX
C00100006	80	INOX
C00100007	100	INOX

Part No.	Gasket Material
G00001024	O-Ring EPDM

DIMENSIONS

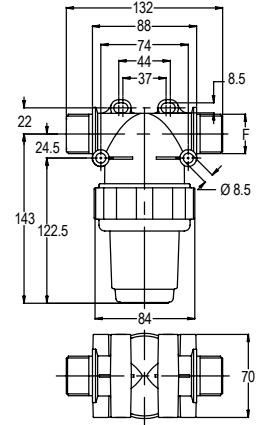

Filtri di mandata per pressioni di esercizio fino a 15 bar.

Line filters for pressures up to 15 bar (220 PSI).

Напорные фильтры для рабочего давления до 15 бар.

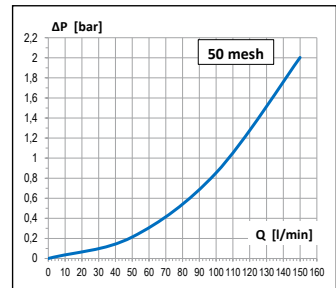

Part No.	F	I/1'	Mesh	Screen Material	Effective Area cm ²	Sq.in.	Pack
8110018			32		38	5,9	
8110019	AF4	150	50	INOX	35	5,4	25
8110020			80		32	5	
8110021			100		34	5,3	

SPARE PARTS

Part No.	Screen Mesh	Screen Material
C00100004	32	INOX
C00100005	50	INOX
C00100006	80	INOX
C00100007	100	INOX

Part No.	Gasket Material
G00001024	O-Ring EPDM

DIMENSIONS

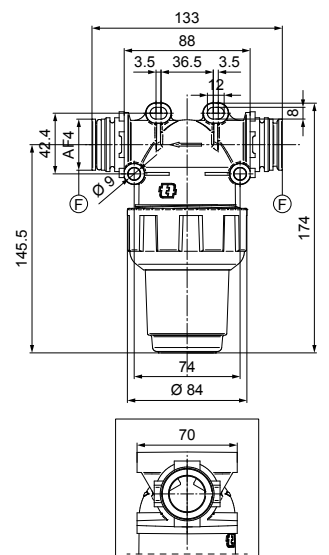

Filtri di mandata autopulenti per pressioni di esercizio fino a 15 bar con filetti femmina.

Self-cleaning line filters for pressures up to 15 bar (220 PSI) - female threads.

Самоочищающиеся напорные фильтры для рабочего давления до 15 бар с внутренней резьбой.

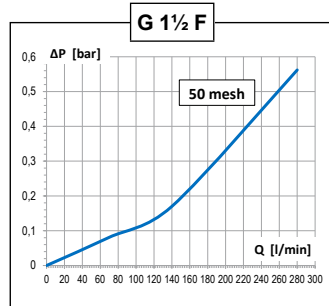
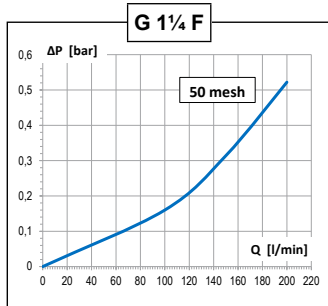
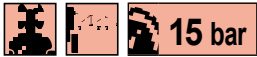

	Part No.	F	I/1'	bar	Mesh	Screen Material	Effective Area cm ²	Sq.in.	Pack
NEW	8122049				16		148,8	23,1	
	8122000				32		116	18	
	8122001	G 1¼ F	200	15	50	INOX	106	16,4	5
	8122002				80		97	15	
NEW	8122003				100		103	16	
	8122050				16		148,8	23,1	
	8122004				32		116	18	
	8122005	G 1½ F	280	15	50	INOX	106	16,4	5
	8122006				80		97	15	
	8122007				100		103	16	

SPARE PARTS

	Part No.	Screen Mesh	Screen Material
	C00100070	16	
	C00100032	32	
	C00100033	50	INOX
	C00100034	80	
	C00100035	100	

	Part No.	Gasket Material
	G00001046	O-Ring EPDM

DIMENSIONS

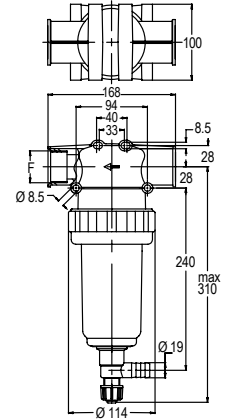

Filtri di mandata autopulenti per pressioni di esercizio fino a 15 bar con filetti maschio.

Self-cleaning line filters for pressures up to 15 bar (220 PSI) - male threads.

Самоочищающиеся напорные фильтры для рабочего давления до 15 бар с наружной резьбой.

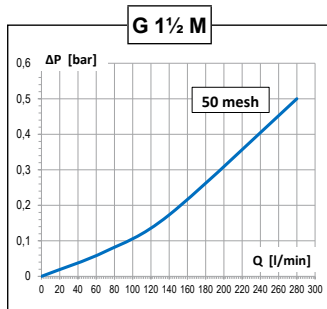
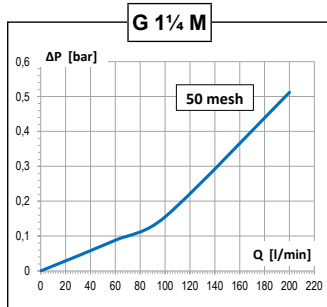

Part No.	F	I/1'	bar	Mesh	Screen Material	Effective Area cm ² Sq.in.	Pack
8128000				32		116 18	
8128001	G 1 1/4 M	200	15	50	INOX	106 16,4	5
8128002				80		97 15	
8128003				100		103 16	
8128004				32		116 18	
8128005	G 1 1/2 M	280	15	50	INOX	106 16,4	5
8128006				80		97 15	
8128007				100		103 16	

SPARE PARTS

Part No.	Screen Mesh	Screen Material
C00100032	32	INOX
C00100033	50	
C00100034	80	
C00100035	100	

Part No.	Gasket Material
G00001046	O-Ring EPDM

DIMENSIONS

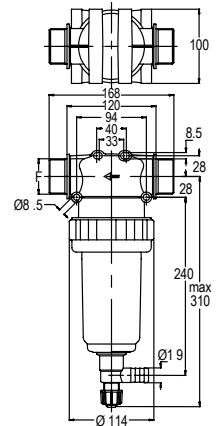

Filtri di mandata autopulenti per pressioni di esercizio fino a 15 bar.

Self-cleaning line filters for pressures up to 15 bar (220 PSI).

Самоочищающиеся напорные фильтры для рабочего давления до 15 бар.

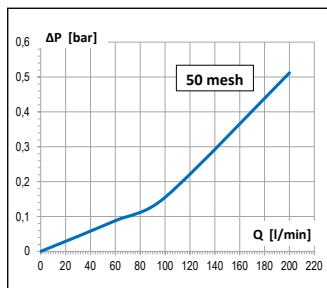

Part No.	F	I/1'	Mesh	Screen Material	Effective Area cm ² Sq.in.	Pack
8128022			32		116 18	
8128023	AF5	280	50	INOX	106 16,4	5
8128024			80		97 15	
8128025			100		103 16	

SPARE PARTS

Part No.	Screen Mesh	Screen Material
C00100032	32	INOX
C00100033	50	
C00100034	80	
C00100035	100	

Part No.	Gasket Material
G00001046	O-Ring EPDM

DIMENSIONS

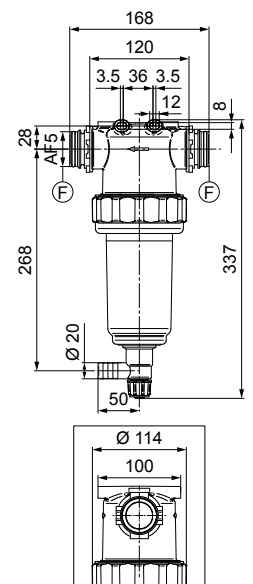

OPTIONALS

AF FORK FITTINGS Pag. 196 - 197

Filtri di mandata autopulenti per pressioni di esercizio fino a 20 bar con filetti maschio.

Self-cleaning line filters for pressures up to 20 bar (290 PSI) - male threads.

Самоочищающиеся напорные фильтры для рабочего давления до 20 бар с наружной резьбой.

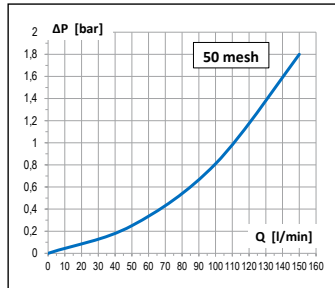
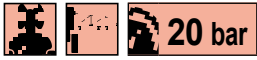

Part No.	F	I/1'	bar	Mesh	Screen Material	Effective Area cm ²	Sq.in.	Pack
8111000				32		38	5,9	
8111001	G 1 M	150	20	50	INOX	35	5,4	10
8111002				80		32	5	
8111003				100		34	5,3	

SPARE PARTS

Part No.	Screen Mesh	Screen Material
C00100004	32	INOX
C00100005	50	INOX
C00100006	80	INOX
C00100007	100	INOX

Part No.	Gasket Material
G00001024	O-Ring EPDM

DIMENSIONS

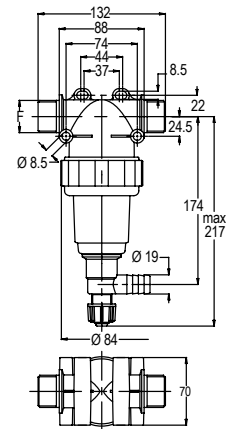

Filtri di mandata autopulenti per pressioni di esercizio fino a 15 bar.

Self-cleaning line filters for pressures up to 15 bar (220 PSI).

Самоочищающиеся напорные фильтры для рабочего давления до 15 бар.

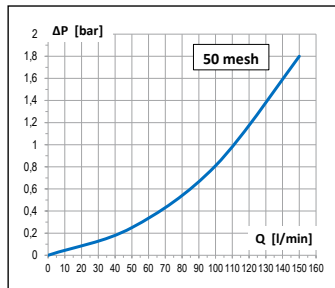

Part No.	F	I/1'	Mesh	Screen Material	Effective Area cm ²	Sq.in.	Pack
8111004			32		38	5,9	
8111005	AF4	150	50	INOX	35	5,4	10
8111006			80		32	5	
8111007			100		34	5,3	

SPARE PARTS

Part No.	Screen Mesh	Screen Material
C00100004	32	INOX
C00100005	50	INOX
C00100006	80	INOX
C00100007	100	INOX

Part No.	Gasket Material
G00001024	O-Ring EPDM

DIMENSIONS

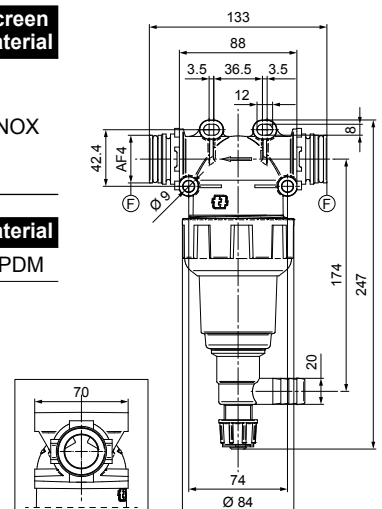

Filtri di mandata autopulenti per pressioni di esercizio fino a 20 bar con filetti femmina.

Self-cleaning line filters for pressures up to 20 bar (290 PSI) - female threads.

Самоочищающиеся напорные фильтры для рабочего давления до 20 бар с внутренней резьбой.

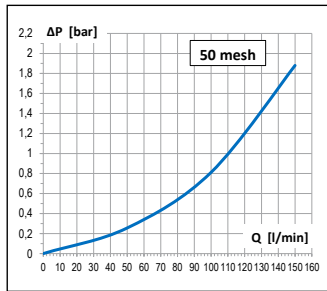
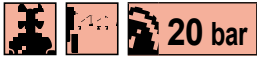

Part No.	F	I/1'	bar	Mesh	Screen Material	Effective Area		Pack
						cm ²	Sq.in.	
NEW 8106016				16		33,9	5,3	
8106000				32		38	5,9	
8106001	G 1 F	150	20	50	INOX	35	5,4	10
8106002				80		32	5	
8106003				100		34	5,3	

SPARE PARTS

Part No.	Screen Mesh	Screen Material
C00100084	16	
C00100004	32	
C00100005	50	INOX
C00100006	80	
C00100007	100	

Part No.	Gasket Material
G00001024	O-Ring EPDM

DIMENSIONS

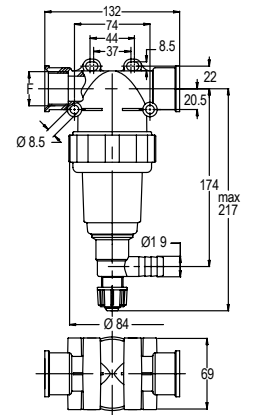

Filtri di mandata per pressioni di esercizio fino a 10 bar (220 PSI). Con filetti femmina.

Line filters for pressures up to 10 bar (145 PSI). Female threads.

Напорные фильтры для рабочего давления до 10 бар (220 PSI) с внутренней резьбой.



COLOR CODING

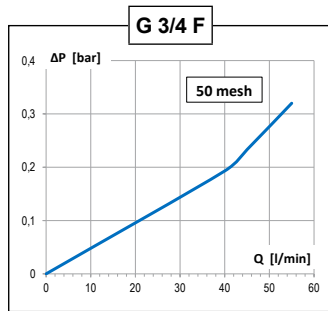
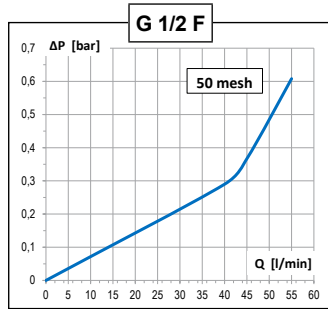

Part No.	F	1/1'	bar	Mesh	Screen Material	Effective Area cm ² Sq.in.	Pack
8105032				32		25,6 4,0	
8105033	G 1/2 F	55	10	50	INOX	23,5 3,6	10
8105034				80		25,6 4,0	
8105035				100		21,5 3,3	
8105024				32		25,6 4,0	
8105025	G 3/4 F	55	10	50	INOX	23,5 3,6	10
8105026				80		25,6 4,0	
8105027				100		21,5 3,3	

SPARE PARTS

Part No.	Screen Mesh	Screen Material
C00100057	32	INOX
C00100058	50	
C00100059	80	
C00100060	100	

Part No.	Gasket Material
G00002052	O-Ring EPDM

DIMENSIONS

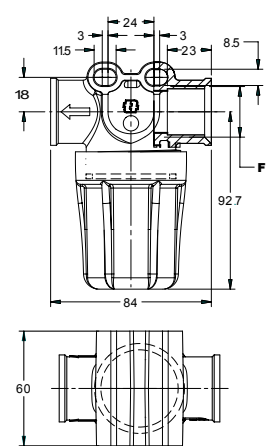

COLOR CODING

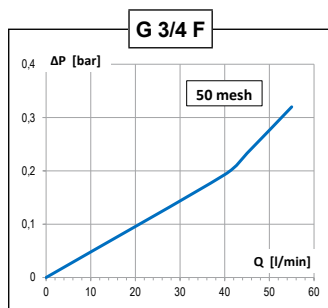
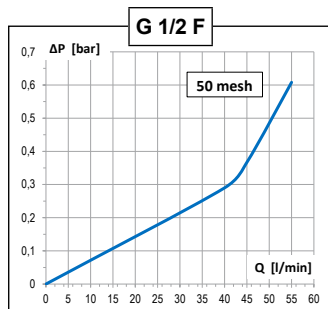

Part No.	F	1/1'	bar	Mesh	Screen Material	Effective Area cm ² Sq.in.	Pack
8105036				32		25,6 4,0	
8105037	G 1/2 F	55	10	50	INOX	23,5 3,6	10
8105038				80		25,6 4,0	
8105039				100		21,5 3,3	
8105040				32		25,6 4,0	
8105041	G 3/4 F	55	10	50	INOX	23,5 3,6	10
8105042				80		25,6 4,0	
8105043				100		21,5 3,3	

SPARE PARTS

Part No.	Screen Mesh	Screen Material
C00100057	32	INOX
C00100058	50	
C00100059	80	
C00100060	100	

Part No.	Gasket Material
G00002052	O-Ring EPDM

DIMENSIONS

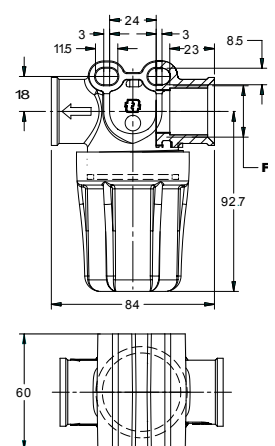

Filtri di mandata per pressioni di esercizio fino a 15 bar (220 PSI). Con filetti maschio.

Line filters for pressures up to 15 bar (220 PSI). With male threads.

Напорные фильтры для рабочего давления до 15 бар (220 PSI) с наружной резьбой.

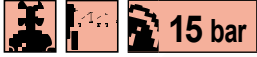

Part No.	F	l/1'	bar	Mesh	Screen Material	Effective Area cm ²	Sq.in.	Pack
8118000				32		38	5,9	
8118001	G 1/2 M	80	15	50	INOX	35	5,4	10
8118002				80		32	5	
8118003				100		34	5,3	
8118004				32		38	5,9	
8118005	G 3/4 M	100	15	50	INOX	35	5,4	10
8118006				80		32	5	
8118007				100		34	5,3	
8118008				32		38	5,9	
8118009	G 1 M	150	15	50	INOX	35	5,4	10
8118010				80		32	5	
8118011				100		34	5,3	

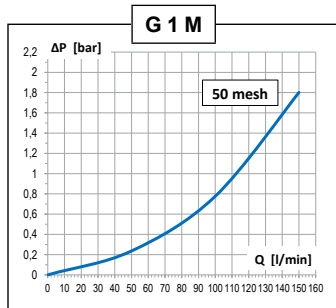
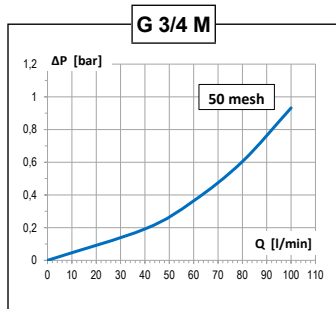
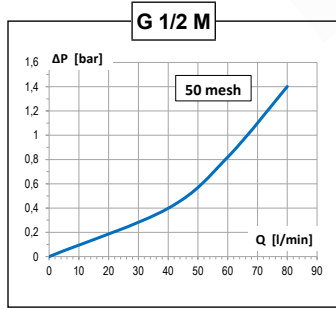

SPARE PARTS

Part No.	Screen Mesh	Screen Material
C00100004	32	INOX
C00100005	50	
C00100006	80	
C00100007	100	

Part No.	Gasket Material
G00001024	O-Ring EPDM

DIMENSIONS

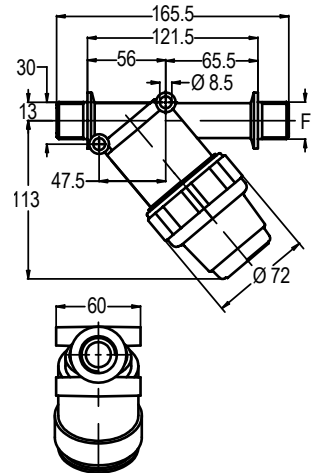

Filtri galleggianti di aspirazione

- Filtro galleggiante realizzato in materiale plastico antiurto.
- Il raccordo girevole (da ordinare a parte) garantisce un perfetto galleggiamento del filtro anche con tubo di collegamento attorcigliato.

Floating filters

- Suction floating filter in shock-resistant plastic.
- The swivel fitting (to be ordered separately) assures the perfect floating even in case of twisted pipe.

Плавающие всасывающие фильтры

- Плавающий фильтр из пластикового противоударного материала.
- Поворотный фитинг (заказывается отдельно) гарантирует превосходную плавучесть фильтра, в том числе с перекрученной соединительной трубой.

Ordinare il raccordo separatamente
Fitting to be ordered separately
Фитинг заказывается отдельно

Part No.	F mm	Pack
R0000020	33	5
R0000021	35	
R0000022	40	
R0000023	50	



Part No.	Pack
8062003	4

DIMENSIONS

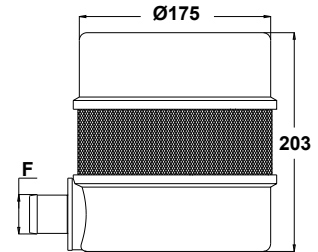

Cestini di fondo.

Foot filters.

Нижние фильтры.

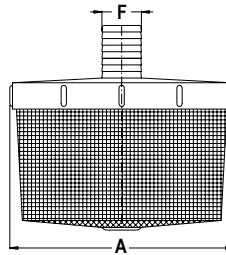

Part No.	A mm	F mm	Type	Pack
8060000	100	15		25
8060001		20		25
8060002	137	20		25
8060003		25		25
8060004		30		10
8060005	137	30		10
8060006		35		
8060007		40		

Filtri di aspirazione per detersivo (con contrappeso).

Suction filters for detergents (with counterweight).

Всасывающие фильтры для моющего средства (с противовесом).

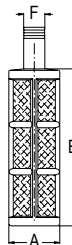

Part No.	F mm	A mm	B mm	Screen Mesh	Pack
8064000	8	22	40	40	10

Filtri di aspirazione

Suction filters

Всасывающие фильтры

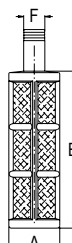

Part No.	F mm	A mm	B mm	Screen Mesh	Pack
8064002	19	42	65	30	10
8064003	25	42	65	30	10

Filtri di mandata per portate fino a 150 l/min e pressioni fino a 50 bar.

Line filters for flow rates up to 150 l/min (40 USGpm) and pressure up to 50 bar (720 PSI).

Напорные фильтры для расхода до 150 л/мин. и давления до 50 бар.

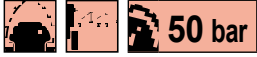

Part No.	F	l/1'	bar	Mesh	Screen Material	Effective Area		Pack
						cm ²	Sq.in.	
8135000				32		70	10,9	
8135001	G 3/4 F	150	50	50	INOX	64	10	5
8135002				80		59	9,1	
8135009				100		59,2	9,2	

SPARE PARTS

Part No.	Screen Mesh	Screen Material
C00100014	32	INOX
C00100015	50	
C00100016	80	
C00100073	100	

Part No.	Gasket	Material
G00001032	O-Ring	EPDM

DIMENSIONS

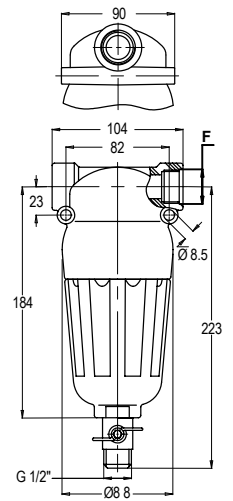

Tappo in ottone

Brass plug

Латунная заглушка

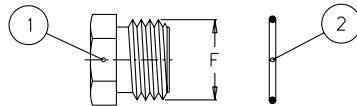

Part No. 1	Part No. 2	F	Pack
8304000	G00001058	G 3/4 M	10

Nipplo in ottone

Brass nipple

Латунный нипель

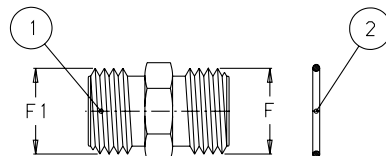

Part No. 1	Part No. 2	F	F1	Pack
8304001	G00001058	G 3/4 M	G 1/2 M	10
8304002	G00001058	G 3/4 M	G 3/4 M	10

Filtri di mandata in ottone per portate fino a 70 l/min e pressioni fino a 50 bar.

Brass line filters for flow rates up to 70 l/min (18.5 USGpm) and pressure up to 50 bar (720 PSI).

Напорные латунные фильтры для расхода до 70 л/мин. и давления до 50 бар.



Part No.	F	l/1'	bar	Mesh	Screen Material	Pack
8137009				30	INOX	
8137008	G 1/2 F	70	50	40	INOX	5
8137010				70	INOX	
8137021				100	INOX	

SPARE PARTS

Part No.	Screen Mesh	Screen Material
C00100051	30	INOX
C00100042	40	
C00100052	70	
C00100075	100	

DIMENSIONS

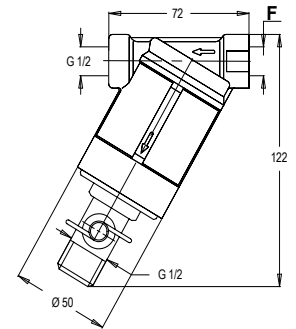

Filtri di mandata in ottone per portate fino a 70 l/min e pressioni fino a 50 bar.

Brass line filters for flow rates up to 70 l/min (18.5 USGpm) and pressure up to 50 bar (720 PSI).

Напорные латунные фильтры для расхода до 70 л/мин. и давления до 50 бар.

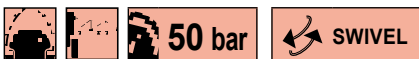

Part No.	F	l/1'	bar	Mesh	Screen Material	Pack
8137011				30	INOX	
8137004	G 1/2 F	70	50	40	INOX	5
8137012				70	INOX	
8137022				100	INOX	

SPARE PARTS

Part No.	Screen Mesh	Screen Material
C00100051	30	INOX
C00100042	40	
C00100052	70	
C00100075	100	

DIMENSIONS

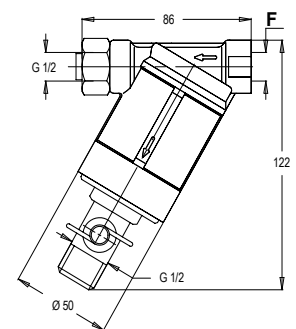

Filtri di mandata in ottone per portate fino a 150 l/min e pressioni fino a 50 bar.

Brass line filters for flow rates up to 150 l/min (40 USGpm) and pressure up to 50 bar (720 PSI).

Напорные латунные фильтры для расхода до 150 л/мин. и давления до 50 бар.



Part No.	F	l/1'	bar	Mesh	Screen Material	Effective Area cm ²	Sq.in.	Pack
8137006				30				
8137007	G 3/4 F	150	50	40	INOX	145	22	5
8137015				80				
8137016				100				
8137013				30				
8137014	G 1/2 F	150	50	40	INOX	145	22	5
8137017				80				
8137018				100				

SPARE PARTS

Part No.	Screen Mesh	Screen Material
C00100043	30	INOX
C00100044	40	
C00100053	80	
C00100054	100	

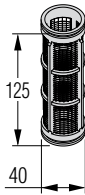

DIMENSIONS

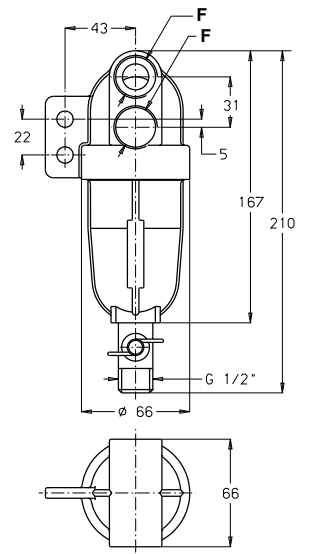

Filtro a siluro per portate fino a 110 l/min e pressioni fino a 50 bar.

"Torpedo" filter for flow rates up to 110 l/min (29 USGpm), max. pressure 50 bar (720 PSI).

Напорные латунные фильтры для расхода до 110 л/мин. и давления до 50 бар.



Part No.	F	l/1'	bar	Mesh	Screen Material	Pack
8137005	G 1/2 M	110	50	40	INOX	5

SPARE PARTS

Part No.	Screen Mesh	Screen Material
C00100041	40	INOX

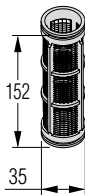

DIMENSIONS

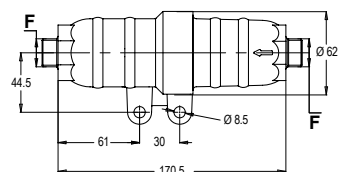

3 FILTRI DI ASPIRAZIONE E MANDATA

SUCTION AND LINE FILTERS / ВСАСЫВАЮЩИЕ И НАПОРНЫЕ ФИЛЬТРЫ



Filtri di mandata in ottone per portate fino a 30 l/min e pressioni fino a 15 bar.

Brass line filters for flow rates up to 30 l/min (8 USGpm) and pressure up to 15 bar (220 PSI).

Напорные латунные фильтры для расхода до 30 л/мин. и давления до 15 бар.

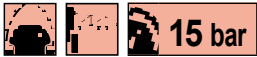

Part No.	F	l/1'	bar	Mesh	Pack
0211000520	G 1/2 F	30	15	45	10
0211000530	G 3/4 F				

Filtri di mandata in ottone per portate fino a 30 l/min e pressioni fino a 310 bar.

Brass line filters for flow rates up to 30 l/min (8 USGpm) and pressure up to 310 bar (4550 PSI).

Напорные латунные фильтры для расхода до 30 л/мин. и давления до 310 бар.



Part No.	F	F1	l/1'	bar	Mesh	Screen Material	Pack
0211000660	G 1/4 F	R 1/4 M	30	310	110	INOX	5



LEGENDA

FEATURES



Prodotti non per uso alimentare
Products not for food use
Не годится для пищевых продуктов



Temperatura massima
Max temperature
Максимальная температура

RACCORDERIA IN POLIPROPILENE 4

POLYPROPYLENE FITTINGS / ПОЛИПРОПИЛЕНОВЫЕ ФИТИНГИ

Raccorderia in polipropilene

La raccorderia GEOLINE è realizzata in polipropilene (altri materiali a richiesta) e Guarnizioni in EPDM (Viton® a richiesta).

I Girelli, le Ghiere e i tappi GEOLINE sono realizzati in polipropilene rinforzato con fibra di vetro (altri materiali a richiesta) e Guarnizioni in EPDM (Viton® a richiesta).

Le filettature GEOLINE sono conformi alle normative BSP (altre filettature a richiesta).

Polypropylene fittings

GEOLINE fittings are made of polypropylene (other materials on demand), with EPDM Gaskets (Viton® on demand).

GEOLINE fly nuts, back nuts and cups are made of fiberglass reinforced polypropylene (other materials on demand), with EPDM Gaskets (Viton® on demand).

GEOLINE threads comply with BSP standards (other threads on demand).

Полипропиленовые фитинги

Фитинги GEOLINE из полипропилена (другие материалы по заявке), а прокладки из EPDM (Viton® по заявке).

Барашиковые гайки, зажимные гайки и заглушки GEOLINE выполнены из полипропилена, усиленного стекловолокном (другие материалы по заявке), прокладки из EPDM (Viton® по заявке).

Резьба GEOLINE соответствует требованиям стандартов BSP (другая резьба по заявке).



Portagomma dritto attacco a forchetta femmina
Straight hoesetail with female fork coupling
Прямой штуцер с вилочным креплением "мама"

NYLON

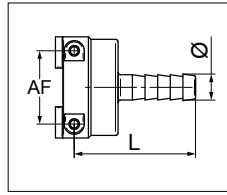
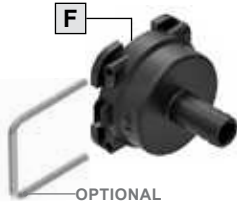

Part No.	AF	Ø mm	L mm	Pack	Fork
8415301		10	48	25	
8415302		13	48	25	
8415303	3	16	48	25	F00000025
8415304		20	54	25	
8415305		25	54	25	
8415501		13	52	25	
8415502		16	52	25	
8415503		20	58	25	
8415504		25	58	25	
8415505	5	30	58	25	F00000029
8415506		32	61	25	
8415507		35	63	25	
8415508		38	69	25	
8415509		40	69	25	

Portagomma curvo 90° attacco a forchetta femmina
90° hoesetail with female fork coupling
Штуцер 90° с вилочным креплением "мама"

NYLON

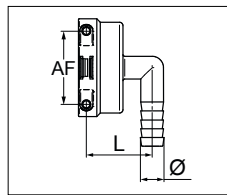
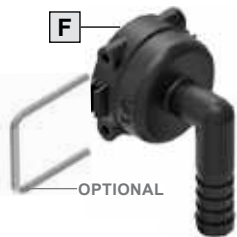

Part No.	AF	Ø mm	L mm	Pack	Fork
8419501		13	38	25	
8419502		16	38	25	
8419503		20	38	25	
8419504		25	38	25	
8419505	5	30	38	25	F00000029
8419506		32	38	25	
8419507		35	38	25	
8419508		38	38	25	
8419509		40	38	25	

Tappo attacco a forchetta femmina
Female fork coupling plug
Заглушка с вилочным креплением "мама"

NYLON

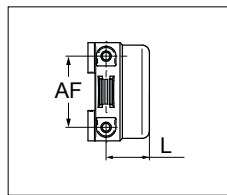
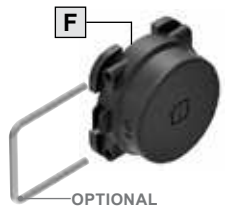

Part No.	AF	L mm	Pack	Fork
8459301	3	18	25	F00000025
8459501	5	21	25	F00000029

Manicotto attacco a forchetta femmina
Female fork coupling plug
Патрубок с вилочным креплением "мама"

NYLON

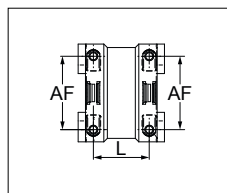
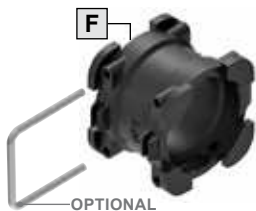

Part No.	AF	L mm	Pack	Fork
8433501	5	32	1	F00000029

Portagomma dritto attacco a forchetta maschio
 Straight hoesetail with male fork coupling
 Прямой штуцер с вилочным креплением "папа"

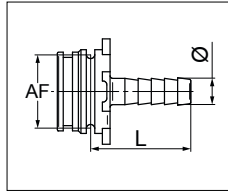
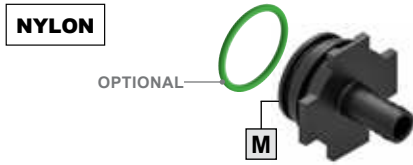

Part No.	AF	Ø mm	L mm	Pack	EPDM	VITON®
					O-ring	O-ring
8416301		10	38	25		
8416302		13	38	25		
8416303	3	16	38	25	G00001020	G00001021
8416304		20	44	25		
8416305		25	44	25		
8416306		30	44	25		
8416501		13	40	25		
8416502		16	40	25		
8416503		20	45	25		
8416504		25	45	25		
8416505	5	30	45	25	G00001277	G00001074
8416506		32	49	25		
8416507		35	51	25		
8416508		38	57	25		
8416509		40	57	25		

Portagomma curvo 90° attacco a forchetta maschio
 90° hoesetail with male fork coupling
 Штуцер 90° с вилочным креплением "папа"

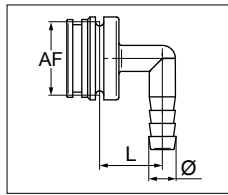
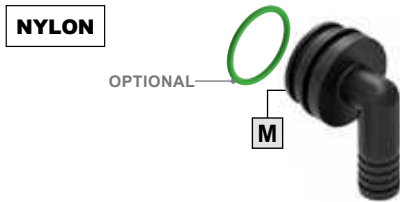

Part No.	AF	Ø mm	L mm	Pack	EPDM	VITON®
					O-ring	O-ring
8420301		10	24	25		
8420302		13	24	25		
8420303	3	16	24	25	G00001020	G00001021
8420304		20	24	25		
8420305		25	24	25		
8420501		13	35	25		
8420502		16	35	25		
8420503		20	35	25		
8420504		25	35	25		
8420505	5	30	35	25	G00001277	G00001074
8420506		32	35	25		
8420507		35	35	25		
8420508		38	35	25		
8420509		40	35	25		

Tappo attacco a forchetta maschio
 Male fork coupling plug
 Заглушка с вилочным креплением "папа"

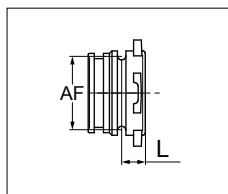
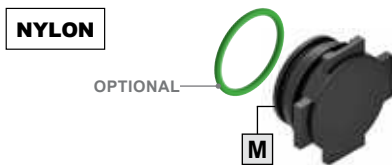

Part No.	AF	L mm	Pack	EPDM	VITON®
				O-ring	O-ring
8460301	3	9	25	G00001020	G00001021
8460501	5	11	25	G00001277	G00001074

Nipplo attacco a forchetta maschio
 Male fork coupling plug
 Патрубок с вилочным креплением "папа"

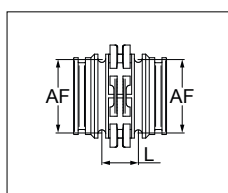
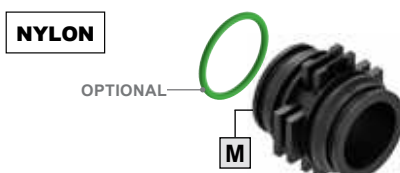

Part No.	AF	L mm	Pack	EPDM	VITON®
				O-ring	O-ring
8434301	5	17	1	G00001277	G00001074
8434501	5	20	1	G00001277	G00001074

Raccordo portagomma diritto per girello
 Hosetail for fly nut
 Прямой штуцер для барашковой гайки

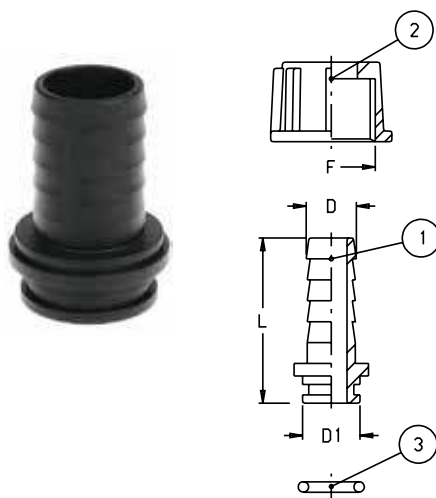

Part No. 1	Part No. 2	Part No. 3	F	D mm	D1 mm	L mm	Pack
8002150	8040151	G00001002	G 1/2	11	13,7	33	25
8002151	8040152	G00001002		13	13,7	33	
8002200	8040201	G00001012	G 3/4	13	17,5	44	25
8002201	8040201	G00001012		15	17,5	44	
8002202	8040202	G00001012		19	17,5	49	
8002250	8040251	G00001018	G 1	13	24,5	49	25
8002251	8040251	G00001018		15	24,5	50	
8002252	8040251	G00001018		19	24,5	51	
8002253	8040251	G00001018		22	24,5	51	
8002254	8040251	G00001018		25	24,5	51	
8002300	8040301	G00001022	G 1 1/4	22	31,5	53	25
8002301	8040301	G00001022		25	31,5	53	
8002302	8040301	G00001022		30	31,5	60	
8002303	8040301	G00001022		32	31,5	63	
8002356	8040351	G00001028	G 1 1/2	15	37,5	38	25
8002350	8040351	G00001028		25	37,5	55	
8002351	8040351	G00001028		30	37,5	62	
8002352	8040351	G00001028		32	37,5	65	
8002353	8040351	G00001028		35	37,5	70	
8002354	8040351	G00001028		38	37,5	72	
8002355	8040351	G00001028		40	37,5	72	
8002400	8040401	G00001030 x2	G 2	40	47	78	10
8002401	8040401	G00001030 x2		45	47	81	
8002402	8040401	G00001030 x2		50	47	84	
8002501	8040501	G00001285 x2	G 3	76	75	90	10

Raccordo portagomma curvo 90° per girello
 90° Hosetail for fly nut
 Штуцер-коллено 90° для барашковой гайки

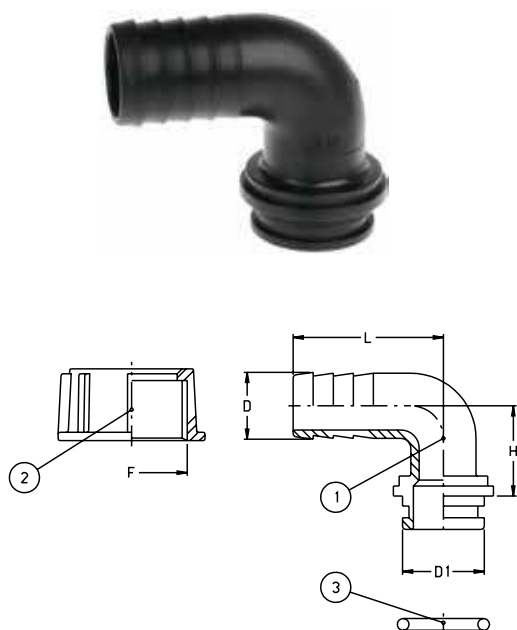

Part No. 1	Part No. 2	Part No. 3	F	D mm	D1 mm	H mm	L mm	Pack
8012200	8040202	G00001012	G 3/4	13	17,5	31,5	37	25
8012201	8040202	G00001012		15	17,5	29,0	40	
8012203	8040202	G00001012		19	17,5	33,0	45	
8012250	8040251	G00001018	G 1	15	24,5	27,0	40	25
8012251	8040251	G00001018		19	24,5	37,0	45	
8012252	8040251	G00001018		25	24,5	37,0	53	
8012300	8040301	G00001022	G 1 1/4	22	31,5	40,5	53	25
8012301	8040301	G00001022		25	31,5	40,5	53	
8012302	8040301	G00001022		30	31,5	42,5	60	
8012303	8040301	G00001022		32	31,5	42,5	60	
8012350	8040351	G00001028	G 1 1/2	25	37,5	41,5	53	25
8012351	8040351	G00001028		30	37,5	41,5	60	
8012352	8040351	G00001028		32	37,5	41,5	60	
8012353	8040351	G00001028		35	37,5	52,5	80	
8012354	8040351	G00001028		38	37,5	52,5	85	
8012355	8040351	G00001028		40	37,5	52,5	85	
8012400	8040401	G00001030 x2	G 2	40	47	47,0	85	10
8012401	8040401	G00001030 x2		45	47	54,0	90	
8012402	8040401	G00001030 x2		50	47	54,0	90	
8012403	8040401	G00001030 x2		52	47	54,0	90	
8012501	8040501	G00001285 x2	G 3	76	75	83,0	125	1

Raccordo portagomma diritto con battuta piana per girello
Flat seat hosetail for fly nut
Прямой штуцер с плоским седлом для барашковой гайки

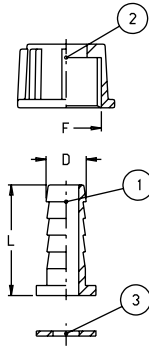

Part No. 1	Part No. 2	Part No. 3	F	D mm	L mm	Pack
8003100	8040101	G00002000	G 3/8	11	37	25
8003150	8040152	G00002002	G 1/2	11	37	25
8003151	8040152	G00002002		13	37	
8003200	8040201	G00002004	G 3/4	15	36	25
8003201	8040201	G00002004		19	41	
8003250	8040251	G00002006	G 1	25	41	25
8003300	8040301	G00002010	G 1 1/4	30	49	

Raccordo portagomma curvo 90° con battuta piana per girello
90° flat seat hosetail for fly nut.
Штуцер-колелно 90° с плоским седлом для барашковой гайки.

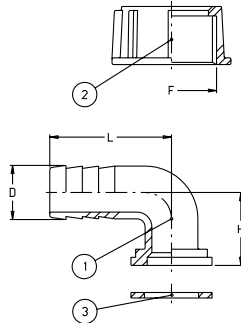

Part No. 1	Part No. 2	Part No. 3	F	D mm	H mm	L mm	Pack
8013150	8040152	G00002002	G 1/2	11	28,5	33	25
8013200	8040201	G00002004	G 3/4	13	31,5	36	25
8013201	8040202	G00002004		19	33	45	
8013250	8040251	G00002006	G 1	25	36,5	53	25
8013300	8040301	G00002010	G 1 1/4	30	44	60	25

Raccordo portagomma curvo 45° per girello
45° hosetail for fly nut
Штуцер-угольник 45° для барашковой гайки

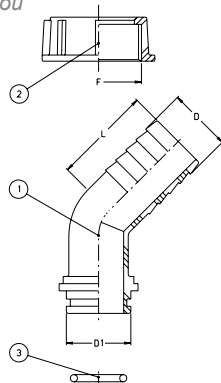

Part No. 1	Part No. 2	Part No. 3	F	D mm	D1 mm	L mm	Pack
8015300	8040301	G00001022	G 1 1/4	30	31,5	48	25
8015350	8040351	G00001028		30	37,5	48	
8015351	8040351	G00001028	G 1 1/2	35	37,5	48	25
8015352	8040351	G00001028		40	37,5	51	
8015400	8040401	G00001030	G 2	40	47	60	25

Raccordo portagomma curvo 45° con filetto maschio
45° male threaded hosetail
Штуцер-угольник 45° с наружной резьбой

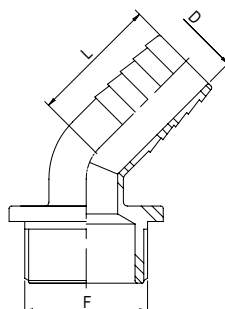

Part No.	F	D mm	L mm	Pack
8014300	G 1 1/4	30	55	25
8014301		35	55	
8014302		40	55	
8014350	G 1 1/2	30	55	25
8014351		35	55	
8014352		40	60	

Raccordo portagomma diritto filetto maschio
 Hosetail male thread
 Прямой штуцер с наружной резьбой

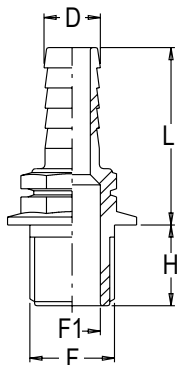

Part No.	F	F1 mm	D mm	H mm	L mm	Pack
8001101	G 3/8	10	11	20	43	25
8001151		14	13	20	44	
8001152	G 1/2	14	15	20	44	25
8001153		14	19	20	49	
8001154		14	22	20	48	
8001201		18	13	22	46	
8001202		18	15	22	46	
8001203	G 3/4	18	19	22	51	25
8001204		18	22	22	51	
8001205		18	25	22	51	
8001251		25	19	22	53	
8001252	G 1	25	25	22	53	25
8001253		25	30	22	60	
8001254		25	32	22	63	
8001301		32	25	24	55	
8001302		32	30	24	63	
8001303	G 1 1/4	32	32	24	65	25
8001304		32	35	24	69	
8001305		32	38	24	72	
8001306		32	40	24	72	
8001351		38	40	24	72	
8001352	G 1 1/2	38	45	24	75	25
8001353		38	50	24	78	
8001401	G 2	47,5	52	27	78	10
8001501	G 3	75,5	76	35	103,5	10

Raccordo portagomma curvo 90° filetto maschio
 90° hosetail - male thread
 Штуцер-колелно 90° с наружной резьбой

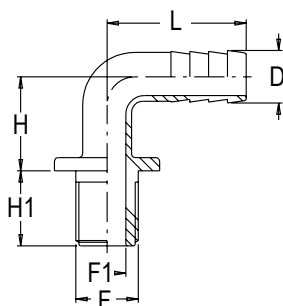

Part No.	F	F1 mm	D mm	H mm	L mm	H1 mm	Pack
8011101	G 3/8	10	13	25	37	20	25
8011102		10	15	25	37	20	
8011151		14	13	25	37	20	
8011152		14	15	25	37	20	
8011153	G 1/2	14	19	25	37	20	25
8011154		14	13	25	37	27	
8011155		14	15	25	37	27	
8011156		14	19	25	37	27	
8011201		18	15	31	45	22	
8011202	G 3/4	18	19	31	53	22	25
8011203		18	25	31	53	22	
8011251		25	25	31	53	22	
8011252	G 1	25	30	31	60	22	25
8011253		25	32	31	60	22	
8011301		32	25	32	60	24	
8011302		32	30	32	60	24	
8011303	G 1 1/4	32	32	32	60	24	25
8011305		32	35	47	85	24	
8011304		32	40	47	85	24	
8011351		38	30	47	80	24	
8011352		38	32	47	80	24	
8011353	G 1 1/2	38	35	47	80	24	25
8011354		38	38	47	80	24	
8011355		38	40	47	85	24	
8011401	G 2	47,5	50	53	90	27	10
8011402		47,5	52	53	95	27	
8011501	G 3	75,5	76	90	125	35	10

Raccordo portagomma curvo 90° filetto NPT maschio
90° hoesetail - NPT male thread
Штуцер-колелно 90° с наружной резьбой NPT

NYLON

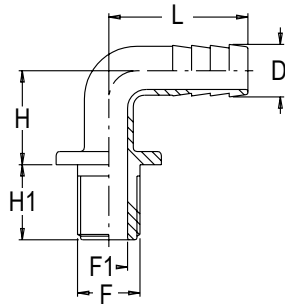

Part No.	F	B mm	D mm	H mm	L mm	H1 mm	Pack
8011339	1"¼ NPT M	24,5	32	32	60	24	10
8011340	1"¼ NPT M	30	38	47	80	24	
8011389	1"½ NPT M	30	38	47	80	24	
8011439	2" NPT M	43	52	53	95	27	

Raccordo a gomito 90° filetti femmina
90° elbow-female threads
Штуцер-колелно 90° с внутренней резьбой

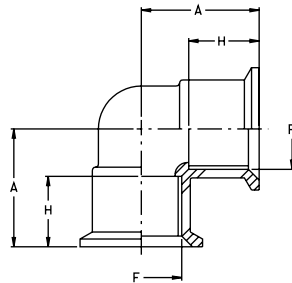

Part No.	F	H mm	A mm	Pack
8019151	G 1/2	21	33,5	25
8019201	G 3/4	23	38,5	25
8019251	G 1	23	42,5	25
8019301	G 1¼	25	50	10
8019351	G 1½	25	52,5	10
8019401	G 2	28	62,5	10

Raccordo a gomito 90° filetti maschio-femmina
90° elbow-male and female threads
Штуцер-колелно 90° с наружной-внутр. резьбой

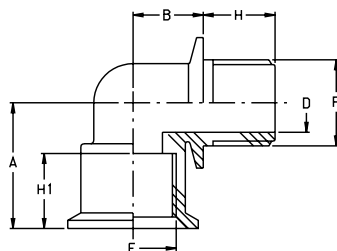

Part No.	F	D mm	H mm	H1 mm	A mm	B mm	Pack
8021151	G 1/2	14	20	21	33,5	13,5	25
8021201	G 3/4	18	22	23	38,5	21,5	25
8021251	G 1	25	22	23	42,5	24,5	25
8021301	G 1¼	32	24	25	50	30	10
8021351	G 1½	38	24	25	52,5	34	10
8021401	G 2	47,5	27	28	62,5	67	10

Raccordo a gomito 90° filetti maschio
90° elbow-male threads
Штуцер-колелно 90° с наружной резьбой

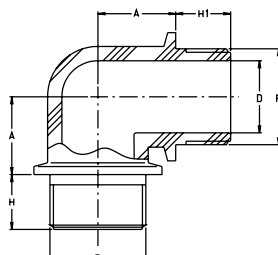

Part No.	F	H mm	H1 mm	A mm	D mm	Pack
8020251	G 1	22	22	27	25	25
8020301	G 1¼	24	24	34	32	10
8020302		24	41	34	32	
8020401	G 2	27	27	44	47,5	10

Raccordo portagomma diritto filetto femmina
Hosetail female thread
Прямой штуцер с внутренней резьбой

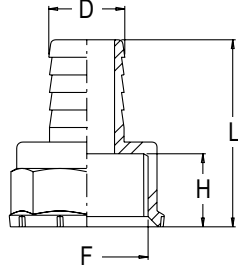

Part No.	F	D mm	H mm	L mm	Pack
8000151	G 1/2	15	21	54	25
8000152		19	25	59	
8000301		19	25	64	
8000302		22	25	64	
8000303	G 1¼	25	25	64	25
8000304		30	25	71	
8000305		32	25	74	
8000306		35	25	79	
8000307	G 1½	40	25	81	25
8000351		35	25	79	
8000352		40	25	81	
8000353		45	25	84	
8000354	G 2	50	25	87	10
8000402		50	28	90	

Raccordo portagomma curvo 90° filetto femmina
90° hosetail female thread
Штуцер-колени 90° с внутренней резьбой

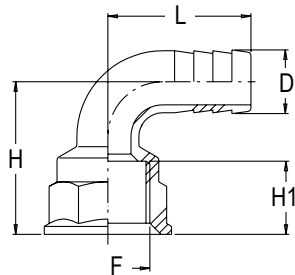

Part No.	F	D mm	H mm	L mm	H1 mm	Pack
8010201	G 3/4	19	48	45	23	25
8010202		22	48	53	23	
8010203		25	52	53	23	
8010204		30	52	60	23	
8010251	G 1	30	62	60	23	25

Kit raccordo tutto un pezzo
Hosetail unit
Узел штуцера

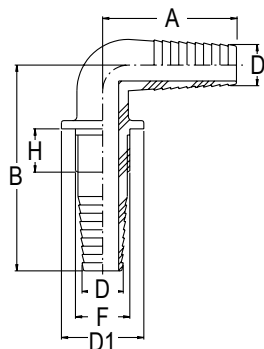

Part No.	F	H mm	D mm	D1 mm	A mm	B mm	Pack
8039151	G 1/2	20	15-17	32	45	80	25
8039201	G 3/4	21	20-24	40	65	100	25
8039251	G 1	22	26-29	44	65	100	25

Raccordo a "T" filetti femmina
Female tee
Тройник с внутренней резьбой

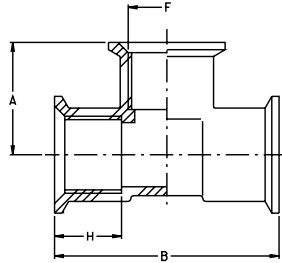

Part No.	F	H mm	B mm	A mm	Pack
8026151	G 1/2	21	67	33,5	25
8026201	G 3/4	23	77	38,5	25
8026251	G 1	23	85	42,5	10
8026301	G 1¼	25	100	50	10
8026351	G 1½	25	105	52,5	5
8026401	G 2	28	125	62,5	5
8026501	G 3	36	169	84,5	5

Raccordo a "T" filetti maschio
Male tee
Тройник с наружной резьбой

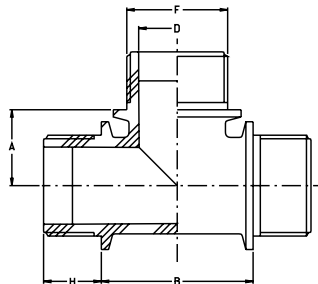

Part No.	F	H mm	B mm	A mm	D mm	Pack
8027301	G 1¼	24	111	55,5	32	10
8027351	G 1½	24	118	59	38	5
8027401	G 2	27	138	69	47,5	5

Raccordo a "T" filetti maschio - femmina
Male and female tee
Тройник с наружной-внутренней резьбой

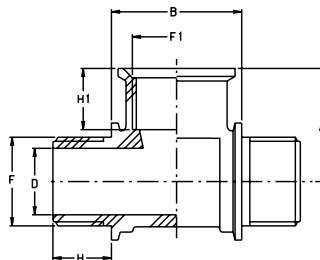

Part No.	F	F1	H mm	H1 mm	A mm	D mm	B mm	Pack
8028251	G 1	G 1	22	23	25	49	42,5	10
8028301	G 1¼	G 1 1/4	24	25	32	60	50	10
8028351	G 1½	G 1 1/2	24	25	38	64	52,5	5
8028401	G 2	G 2	27	28	47,5	76	62,5	5

Giunto filettato maschio
Male threaded connector
Соединитель с наружной резьбой

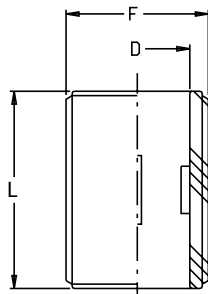

Part No.	F	D mm	L mm	Pack
8052201	G 3/4	18	46	25
8052251	G 1	25	46	25
8052301	G 1¼	32	50	25
8052351	G 1½	38	50	10
8052401	G 2	47,5	56	10

Nipplo
Nipple
Ниппель

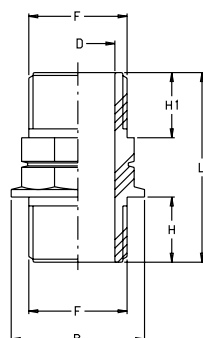

Part No.	F	B mm	H mm	D mm	L mm	H1 mm	Pack
8056151	G 1/2	32	20	14	54	20	25
8056152		32	38	14	75	20	
8056201	G 3/4	40	22	18	60	22	25
8056202		40	48	18	86	22	
8056251	G 1	45	22	25	64	22	25
8056252		45	28	25	70	22	
8056253		45	48	25	90	22	
8056301	G 1¼	54,5	24	32	68	24	25
8056302		54,5	50	32	94	24	
8056351	G 1½	62	24	38	68	24	25
8056352		62	50	38	94	24	
8056401	G 2	76	27	47,5	74	27	10
8056402		76	50	47,5	97	27	
8056451	G 2½	80	31	63	79,5	31	10
8056501	G 3	95	33,25	73,5	84,5	33,25	10

Nipplo ridotto
Reducing nipple
Редукционный ниппель

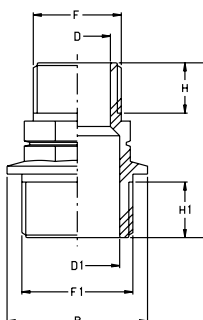

Part No.	F	B mm	H mm	D mm	F1 mm	H1 mm	D1 mm	L mm	Pack
8058101	G 3/8	24	11,5	10	G 1/2	15	14	38,5	25
8058151	G 1/2	40	20	14	G 3/4	22	18	58	25
8058152		44	20	14	G 1	22	25	60	
8058201	G 3/4	44	22	18	G 1	22	25	62	25
8058251	G 1	53	22	25	G 1¼	24	32	66	25
8058301	G 1¼	60	24	32	G 1½	24	38	68	25
8058351	G 1½	76	24	38	G 2	27	47,5	71	10
8058401	G 2	80	26	47,5	G 2½	31	63	75	10
8058451	G 2½	95	31	63	G 3	33	73,5	82	10
8058402	G 2	95	33	47,5	G 3	26	73,5	77	10

Riduzione maschio/femmina
Male and female reducer
Редуктор с наружной/внутренней резьбой

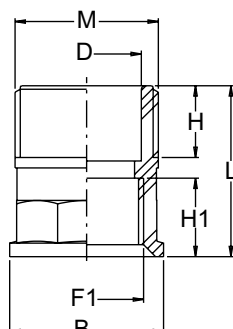

Part No.	M x F1	H mm	H1 mm	L mm	D mm	B mm	Pack
8059151	G 1/2 x G 1/2	20	21	44	14	32	25
8059202	G 3/4 x G 1/2	22	21	46	18	32	25
8059203	G 3/4 x G 1	22	23	48	18	44	25
8059204	G 3/4 x G 1 1/4	22	25	51	18	53	25
8059251	G 1 x G 3/4	24	16,5	45	25	36	25
8059252	G 1 x G 1	22	23	48	25	44	25
8059253	G 1 x G 1 1/4	22	25	51	25	53	25
8059301	G 1 1/4 x G 1	24	23	50	32	45	25
8059302	G 1 1/4 x G 1 1/4	24	25	53	32	53	25
8059303	G 1 1/4 x G 1 1/2	24	25	53	32	60	25
8059304	G 1 1/4 x G 3/4	21,5	16,5	47,5	32	46	25
8059351	G 1 1/2 x G 1 1/4	24	25	53	38	53	10
8059352	G 1 1/2 x G 1	22,5	19,5	53,5	38	50	10
8059401	G 2 x G 1 1/2	24	25	56	47,5	60	10
8059402	G 2 x G 1 1/4	26	22	58,5	47,5	65	10
8059403	G 2 x 3	27	36	74	47,5	106	10
8059451	G 2 1/2 x G 1 1/2	31	23,5	64,5	63	80	10
8059501	G 3 x 2	35	28,5	72,5	75,5	106	10

Manicotto ridotto
Reducing socket
Переходная муфта

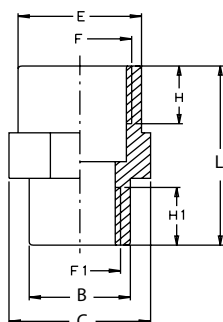

Part No.	F x F1	H mm	H1 mm	L mm	E mm	B mm	C mm	Pack
8057101	G 1/2 x G 3/8	15,5	12	33,25	28	23	36	25
8057151	G 3/4 x G 1/2	16,5	15,5	38,25	34	28	36	25
8057201	G 1 x G 3/4	19,5	16,5	43	42	34	46	25
8057251	G 1 1/4 x G 1	22	20	49	51	42	55	25
8057301	G 1 1/2 x G 1 1/4	23,5	22	50,5	58	51	65	25
8057351	G 2 x G 1 1/2	25	23,5	55	71,5	58	75	10

Manicotto
Socket
Муфта

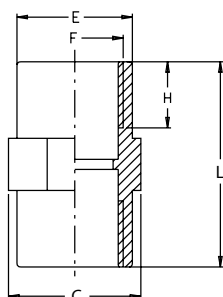

Part No.	F	H mm	L mm	E mm	C mm	Pack
8054101	G 3/8	12	30	23	30	25
8054151	G 1/2	15,5	36,5	28	30	25
8054201	G 3/4	16,5	39,5	34	36	25
8054251	G 1	20	45,5	42	46	25
8054301	G 1 1/4	22	51	51	55	25
8054351	G 1 1/2	23,5	50,5	58	65	10
8054401	G 2	25	59,5	71,5	75	10

Kit bocchettone di scarico
Complete tank outlet
Комплект выпускного патрубка

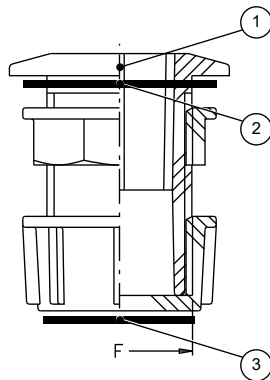

Part No. 1	EPDM	VITON®	EPDM	VITON®	F	Pack
	Part No. 2	Part No. 2	Part No. 3	Part No. 3		
8051151	G00002008	G00002009	G00001014	G00001015	G 1/2	25
8051201	G00002010	G00002011	G00002004	G00002005	G 3/4	25
8051251	G00002012	G00002013	G00002006	G00002007	G 1	25
8051301	G00002014	G00002015	G00002010	G00002011	G 1¼ (long)	25
8051302	G00002014	G00002015	G00002010	G00002011	G 1¼ (short)	25
8051351	G00002016	G00002017	G00002012	G00002013	G 1½	25
8051401	G00002018	G00002019	G00002014	G00002015	G 2	10

Kit bocchettone di scarico completo di guarnizioni. Bianco - atossico
Tank outlet kit with gaskets. White - non-toxic
Комплект выпускного патрубка с прокладками. Белый цвет - не токсичный

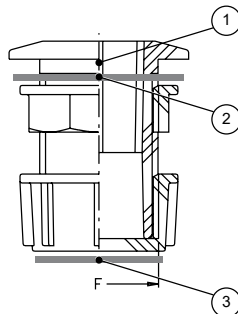

Part No. 1	F	Pack
8359201	G 3/4	25
8359251	G 1	25
8359301	G 1¼	25
8359351	G 1½	25
8359401	G 2	20

SPARE PARTS

Part No. 2	Pack	Part No. 3	Pack
G00002031	50	G00002034	50
G00002027	50	G00002026	50
G00002028	20	G00002031	50
G00002029	50	G00002027	50
G00002030	20	G00002028	20

Bocchettone di scarico
Tank outlet
Выпускной патрубок

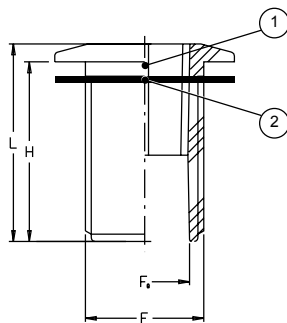

Part No. 1	EPDM	VITON®	F	H mm	L mm	Fo mm	Pack
	Part No. 2	Part No. 2					
8050151	G00002008	G00002009	G 1/2	43,5	47	14	25
8050201	G00002010	G00002011	G 3/4	43,5	48	18	25
8050251	G00002012	G00002013	G 1	50	55	25	25
8050301	G00002014	G00002015	G 1¼	40	46	32	25
8050302	G00002014	G00002015	G 1¼	48	54	32	25
8050351	G00002016	G00002017	G 1½	45	51	38	25
8050401	G00002018	G00002019	G 2	64	71	47,5	10

Kit aspirazione antivortice con scarico antinquinante

Kit aspirazione antivortice con scarico antinquinante di nuova concezione permette di abbinare le funzioni di aspirazione pompa e di scarico cisterna nel rispetto delle vigenti norme CE.

Antivortex suction Kit with antipollution outlet

Antivortex suction kit with antipollution outlet of new conception combining 2 functions: the suction of pump and the emptying of the tank in conformity with E.E.C. directions.

Всасывающий антивихревый комплект с препятствующим загрязнению выпускным отверстием

Всасывающий антивихревый комплект с препятствующим загрязнению выпускным отверстием новой концепции обеспечивает сочетание функций всасывания насоса и спуска емкости в соответствии с действующими нормами ЕС.

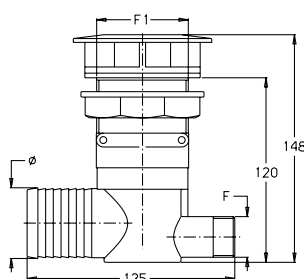

Part No.	Ø mm	F	F1	Pack
8209000	25			
8209001	30			
8209002	35	G 3/4	G 2	10
8209003	40			
8209004	45			

Girello
Fly nut
Барашковая гайка

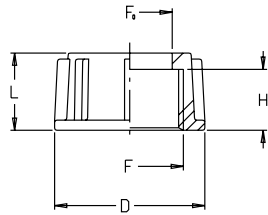

Part No.	F	D mm	H mm	L mm	Fo mm	Pack
8040101	G 3/8	26,5	14	18	13	25
8040151	G 1/2	29	15	19	12,5	25
8040152	G 1/2	29	15	19	15,5	25
8040202	G 3/4	37	15	19	21,8	25
8040251	G 1	44	18	21,5	27,3	25
8040301	G 1¼	55	18	21,5	35	25
8040351	G 1½	63	18	22	41,5	25
8040401	G 2	80	19	24	52,5	10
8040451	G 2½	92	20	24	66	10
8040501	G 3	105	25,5	30	77	10

Ghiera
Back nut
Зажимная гайка

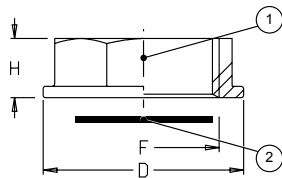

Part No. 1	EPDM	VITON®	F	D mm	H mm	Pack
	Part No. 2	Part No. 2				
8042101	G00001010	G00001011	G 3/8	26,5	13	25
8042151	G00001014	G00001015	G 1/2	29	13	25
8042201	G00002004	G00002005	G 3/4	37	13	25
8042251	G00002006	G00002007	G 1	44	13	25
8042301	G00002010	G00002011	G 1¼	55	15	25
8042351	G00002012	G00002013	G 1½	63	15	25
8042401	G00002014	G00002015	G 2	80	17	10
8042451	/	/	G 2½	105	23	10
8042501	/	/	G 3	125	26,5	10

Tappo filettato femmina
Threaded blanking cap
Заглушка с внутренней резьбой

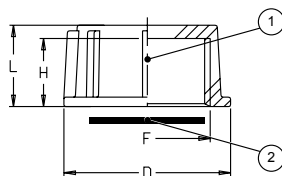

Part No. 1	EPDM	VITON®	F	D mm	H mm	L mm	Pack
	Part No. 2	Part No. 2					
8044101	G00001010	G00001011	G 3/8	26,5	14	18	25
8044151	G00001014	G00001015	G 1/2	29	15	19	25
8044201	G00002004	G00002005	G 3/4	37	15	19	25
8044251	G00002006	G00002007	G 1	44	18	21,5	25
8044301	G00002010	G00002011	G 1¼	55	18	21,5	25
8044351	G00002012	G00002013	G 1½	63	18	22	25
8044401	G00002014	G00002015	G 2	80	19	24	10
8044451	/	/	G 2½	92	20	24	10

Tappo filettato maschio
Threaded male plug
Заглушка с наружной резьбой

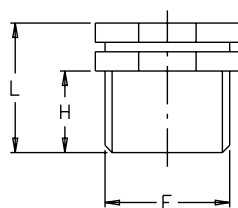

Part No.	F	H mm	L mm	Pack
8046151	G 1/2	15	23	25
8046201	G 3/4	17	27	25
8046251	G 1	19	31	25
8046301	G 1¼	22	34	25
8046351	G 1½	24	36	25
8046401	G 2	24	36	10
8046451	G 2½	31	51	10

Accoppiatori con bloccaggio a camme

I nostri accoppiatori a camme sono realizzati in polipropilene rinforzato con fibra di vetro per garantire ottima resistenza agli agenti chimici e massima durata. Leve di bloccaggio, anelli e spinotti sono in acciaio inossidabile.

Tutti i nostri accoppiatori a camme sono intercambiabili ai prodotti realizzati dai principali costruttori mondiali.

- Filettature NPT a richiesta.
- Guarnizioni di tenuta standard in NBR.

Cam lever couplings

Our comprehensive range of cam lever couplings are made from Glass reinforced polypropylene for strength and durability, featuring stainless steel arms, pins and rings.

They are interchangeable with other couplers and adapters.

- NPT threads on demand.
- NBR standard Gaskets

Муфты с кулачковой блокировкой

Наши кулачковые муфты изготовлены из полипропилена, усиленного стекловолокном для гарантии оптимального сопротивления воздействию химических веществ и максимального срока службы. Блокировочные рычаги, кольца и штифты из нержавеющей стали. Все наши кулачковые муфты взаимозаменяемы с продукцией, выпускаемой крупнейшими мировыми изготовителями.

- Резьба NPT по запросу
- Стандартные уплотнительные прокладки из NBR.



Adattatore maschio » Filetto femmina

Male adapter » Female thread

Переходник » С внутренней резьбой

A



Part No.	Size	F	Pack
8034201	G 3/4	G 3/4	25
8034251	G 1	G 1	25
8034301	G 1¼	G 1¼	25
8034351	G 1½	G 1½	25
8034401	G 2	G 2	25
8034501	G 3	G 3	10

Accoppiatore femmina » Filetto maschio

Female coupler » Male thread

Муфта » С наружной резьбой

B



Part No. 1	Size	F	Pack
8034202	G 3/4	G 3/4	25
8034252	G 1	G 1	25
8034302	G 1¼	G 1¼	25
8034352	G 1½	G 1½	25
8034402	G 2	G 2	25
8034502	G 3	G 3	10

SPARE PARTS

Part No. 2	Pack
G00002063	50
G00002062	50
G00002061	50
G00002060	50
G00002059	50
G00002058	50

Accoppiatore femmina » Portagomma

Female coupler » Hosetail

Муфта » Штуцер

C



Part No. 1	Size	Ø mm	Pack
8034203	G 3/4	19	25
8034253	G 1	25	25
8034304	G 1¼	32	25
8034354	G 1½	38	25
8034403	G 2	50	25
8034503	G 3	75	10

SPARE PARTS

Part No. 2	Pack
G00002063	50
G00002062	50
G00002061	50
G00002060	50
G00002059	50
G00002058	50

Accoppiatore femmina » Filetto femmina.
Female coupler » Female thread
Муфта » С внутренней резьбой.



Part No. 1	Size	F	Pack
8034204	G 3/4	G 3/4	25
8034254	G 1	G 1	25
8034305	G 1¼	G 1¼	25
8034355	G 1½	G 1½	25
8034404	G 2	G 2	25
8034504	G 3	G 3	10

SPARE PARTS

Part No. 2	Pack
G00002063	50
G00002062	50
G00002061	50
G00002060	50
G00002059	50
G00002058	50

Adattatore maschio » Portagomma
Male adapter » Hosetail
Переходник » Штуцер



Part No.	Size	Ø mm	Pack
8034205	G 3/4	19	25
8034255	G 1	25	25
8034307	G 1¼	32	25
8034357	G 1½	38	25
8034405	G 2	50	25
8034505	G 3	75	10

Adattatore maschio » Filetto maschio.
Male adapter » Male thread
Переходник » С наружной резьбой



Part No.	Size	F	Pack
8034206	G 3/4	G 3/4	25
8034256	G 1	G 1	25
8034308	G 1¼	G 1¼	25
8034358	G 1½	G 1½	25
8034406	G 2	G 2	25
8034506	G 3	G 3	10

Tappo per accoppiatore femmina
Cap for female coupler
Заглушка для муфты с внутренней резьбой



Part No. 1	Size	Pack
8034207	G 3/4	25
8034257	G 1	25
8034309	G 1¼	25
8034359	G 1½	25
8034407	G 2	25
8034507	G 3	10

SPARE PARTS

Part No. 2	Pack
G00002063	50
G00002062	50
G00002061	50
G00002060	50
G00002059	50
G00002058	50

Tappo per adattatore maschio
Cap for male adapter
Заглушка для переходника с наружной резьбой



Part No.	Size	Pack
8034208	G 3/4	25
8034258	G 1	25
8034310	G 1¼	25
8034360	G 1½	25
8034408	G 2	25
8034508	G 3	10

Raccordo portagomma a "T"
Tee hosetail
Штуцер-тройник

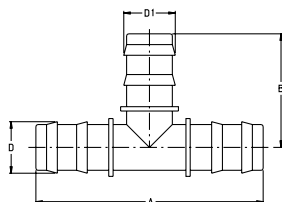

Part No.	D mm	D1 mm	A mm	B mm	Pack
8025000	16	16	68	34	100
8025001	20	20	59	44	100
8025002	25	25	106	47	100
8025004	32	32	130	49	100
8025005	40	40	140	68	50

Raccordo a "Y"
"Y" fitting
"Y"-фитинг

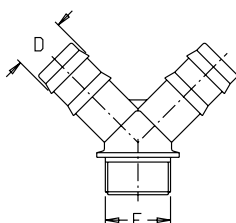

Part No.	F	D mm	Pack
8031000	G 3/4	15	25
8031001	G 3/4	25	25
8031002	G 1	25	25
8031003	G 1	30	25
8031004	G 1 1/4	30	25

Raccordo portagomma diritto di giunzione
Hosetail connector
Прямой соединитель-штуцер

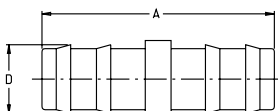

Part No.	D mm	A mm	Pack
8004000	16	59	100
8004001	20	68	100
8004002	25	73	100
8004004	32	73	100
8004003	36	87	50

Raccordo a "T" filetti maschio per raccordi a battuta piana
Male tee for flat seat fittings
Тройник с наружной резьбой для фитингов с плоским седлом

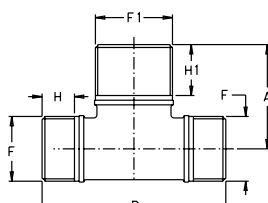

Part No.	F	F1	H mm	H1 mm	A mm	B mm	Pack
8027151	G 1/2	G 1/2	15	15	34	68	50
8027152	G 1/2	G 3/4	15	16,5	35	68	50
8027201	G 3/4	G 3/4	16,5	16,5	35	71	50
8027202	G 3/4	G 1	16,5	17	43	71	50
8027251	G 1	G 1	17	17	43	86	25
8027252	G 1	G 1 1/4	17	19,5	51	86	25

Guarnizioni O-Rings per raccorderia con filetto femmina

O-Ring gaskets for fittings with female thread
Прокладки кольцевых уплотнений для фитингов с внутренней резьбой

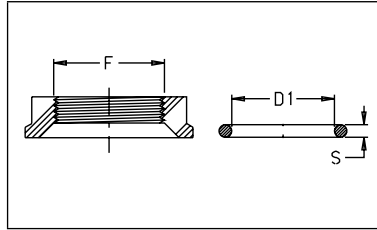

		EPDM	VITON®			
Part No.	Part No.	F	D1 mm	S mm	Pack	
G00001018	G00001019	G 1/2	20,24	2,62	50	
G00001020	G00001021	G 3/4	25,07	2,62	50	
G00001026	G00001027	G 1	29,82	2,62	50	
G00001046	G00001047	G 1¼	39,69	3,53	50	
G00001048	G00001049	G 1½	47,22	3,53	50	
G00001052	G00001053	G 2	58,74	3,53	50	

Guarnizioni O-Rings per raccorderia con girello

O-Ring Gaskets for fittings with fly nut
Прокладки кольцевых уплотнений для фитингов с барашковой гайкой

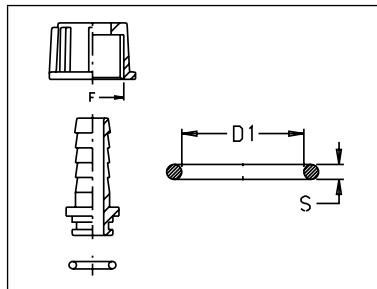

		EPDM	VITON®			
Part No.	Part No.	F	D1 mm	S mm	Pack	
G00001002	G00001003	G 1/2	10,5	2	50	
G00001012	G00001013	G 3/4	13,1	2,62	50	
G00001018	G00001019	G 1	20,24	2,62	50	
G00001022	G00001023	G 1¼	26,65	2,62	50	
G00001028	G00001029	G 1½	31,42	2,62	50	
G00001030	G00001031	G 2	39,34	2,62	50	

Guarnizioni per raccorderia a sede piana con girello

Gaskets for flat seat fittings with fly nut
Прокладки для фитингов с плоским седлом с барашковой гайкой

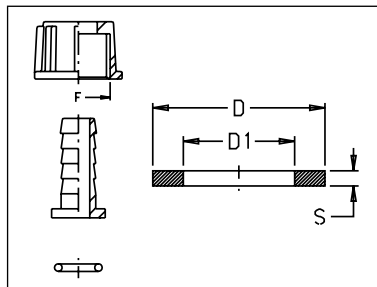

		EPDM	VITON®			
Part No.	Part No.	F	D mm	D1 mm	S mm	Pack
G00002000	G00002001	G 3/8	14	10	2,5	50
G00002002	G00002003	G 1/2	19,2	11,5	2,5	50
G00002004	G00002005	G 3/4	24,5	17	2,5	50
G00002006	G00002007	G 1	30,7	20	2,5	50
G00002010	G00002011	G 1¼	39,5	27,5	2,5	50

Guarnizioni per tappi con filetto femmina
Gaskets for threaded blanking cap
Прокладки для заглушек с внутренней резьбой

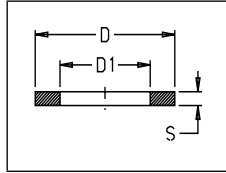
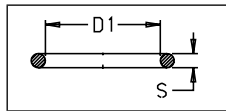
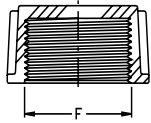

EPDM		VITON®				
Part No.	Part No.	F	D mm	D1 mm	S mm	Pack
G00001010	G00001011	G 3/8	-	11,19	2,62	50
G00001014	G00001015	G 1/2	-	13,95	2,62	50
G00002004	G00002005	G 3/4	24,5	17	2,5	50
G00002006	G00002007	G 1	30,7	20	2,5	50
G00002010	G00002011	G 1¼	39,5	27,5	2,5	50
G00002012	G00002013	G 1½	45	33	3	50
G00002014	G00002015	G 2	60	40	4	50

Guarnizioni piane per raccorderia a parete con filetto maschio
Flat Gaskets for wall fittings with male thread
Плоские прокладки для настенных фитингов с наружной резьбой

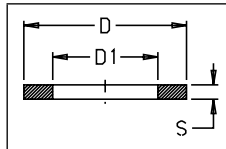
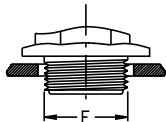

EPDM		VITON®				
Part No.	Part No.	F	D mm	D1 mm	S mm	Pack
G00002044	/	G 1/4	20	13	3	50
G00002004	G00002005	G 3/8	24,5	17	2,5	50
G00002008	G00002009	G 1/2	33	21	2,5	50
G00002010	G00002011	G 3/4	39,5	27,5	2,5	50
G00002012	G00002013	G 1	45	33	3	50
G00002014	G00002015	G 1¼	60	40	4	50
G00002016	G00002017	G 1½	67	47	3	50
G00002018	G00002019	G 2	84	59	4	50
G00002045	/	G 2½	94,5	76	3,5	50
G00002040	/	G 3	110	90	3,5	50

Guarnizioni O-Rings per raccorderia con attacco a forchetta. O-Ring gaskets for fittings with fork couplings.

Кольцевые уплотнения для фитингов с вилочным креплением.

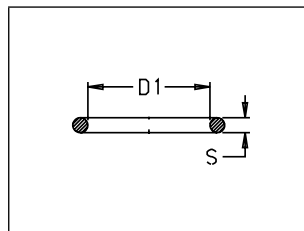

EPDM		VITON®			
Part No.	Part No.	Type	D1 mm	S mm	Pack
G00001020	G00001021	AF3	25,07	2,62	50
G00001276	/	AF4	28,17	3,53	50
G00001277	G00001074	AF5	36,10	3,53	50
G00001278	/	AF6	41,28	3,53	50
G00001050	G00001051	AF7	53,57	3,53	50
G00001054	G00001055	AF9	82,14	3,53	50



LEGENDA

Campo di impiego / Use / Применение



Per macchine a basso volume
For low-volume spraying machines
Для малообъемных опрыскивателей



Per atomizzatori
For orchard sprayers
Для опрыскивателей



Per macchine da diserbo
For crop sprayers
Для штанговых опрыскивателей



Componente modulare
Modular component
Модульный компонент

Caratteristiche / Features / Характеристики



Portata
Flow rate
Расход



Pressione d'esercizio
Operating pressure
Рабочее давление



Peso
Weight
Вес



Temperatura max
Max temperature
Максимальная температура



Tensione di alimentazione
Working voltage
Напряжение питания



Accessori da ordinare separatamente *Accessories to be ordered separately* Заказываемые отдельно аксессуары

FILTER



Cestelli per coperchi
Basket filters for tank lids
Корзинчатые фильтры для крышек

RING



Anelli per coperchi
Rings for tank lids
Кольца для крышек

FEATURES



Prodotti non per uso alimentare
Products not for food use
Не годится для пищевых продуктов

Temperatura massima
Max temperature
Максимальная температура

ARTICOLI PER IMMISSIONE LIQUIDI E DI COMPLETAMENTO 5

BASKET FILTERS, TANK LIDS AND ACCESSORIES
АКСЕССУАРЫ ДЛЯ ЕМКОСТЕЙ

Articoli per immissione liquidi e di completamento

Tutti gli articoli per completamento cisterne GEOLINE sono stati progettati per soddisfare le più diverse esigenze di trasporto di liquidi per uso agricolo e industriale. Sono realizzati in polipropilene, le tenute sono in EPDM (Viton® a richiesta) mentre i particolari metallici sono realizzati in acciaio inox AISI 304.

Basket filters, tank lids and accessories

All GEOLINE basket filters, tank lids and accessories are designed to meet a variety of requirements for transporting liquids for agricultural and industrial applications. They are in polypropylene, with EPDM gaskets (Viton® on demand) and AISI 304 stainless steel parts.

Аксессуары для емкостей

Все аксессуары для емкостей GEOLINE были разработаны в целях удовлетворения различных требований транспортировки жидкостей для использования в сельскохозяйственной и промышленной сфере. Они изготовлены из полипропилена, уплотнения из EPDM (Viton® по заявке), а металлические детали изготовлены из нержавеющей стали AISI 304.



Coperchi per cisterne serie Abat

- Particolarmente indicato per cisterne di grandi capacità, dove vengono applicate pompe di caricamento ad alta portata fino a 600 l/1'.
- La nuova valvola di sfiato garantisce un perfetto passaggio d'aria, non riscontrabile sugli altri coperchi in commercio.

Caratteristiche tecniche:

- struttura in polipropilene
- angolo di ribaltamento massimo di 180°
- tenuta garantita da una sfera galleggiante direttamente a battuta sulla guarnizione .
- angolo di svitamento 10°
- valvola di sfiato con sfera galleggiante.

Tank lids - Abat series

New hinged tank lid ABAT:

-above all suggested for big capacity tanks, on which there are applied pumps at high flow rate until 600 l/1'.
- the new breather valve grants a perfect air passage, not finding in other tank lids on sale

Technical features:

- polypropylene structure
- max upending angle: 180°
- Seal guaranteed by a floating ball sitting directly against the gasket.
- unscrewing angle: 10°
- floating ball vent valve.

Крышки для емкостей серии Abat

- Предназначены для емкостей значительных объемов, где используются загрузочные насосы производительностью до 600 л/1'.
- Новый воздуховыпускной клапан гарантирует превосходное прохождение воздуха, не свойственное всем другим имеющимся в продаже крышкам.

Технические характеристики:

- структура из полипропилена
- максимальный угол открытия 180°
- герметичность гарантируется плавающей сферой в упоре о прокладку.
- угол откручивания 10°
- воздуховыпускной клапан с плавающей сферой.



Part No.	ØA mm	ØC mm	B mm	D mm	BREATHER	Pack
8169014	357	320	380	120	FLOATING BALL VENT VALVE	8
8170015	457	415	480	120	FLOATING BALL VENT VALVE	8
8169015	357	320	380	120	CLOSED	8
8170016	457	415	480	120	CLOSED	8



Ordinare filtro separatamente
Filter to be ordered separately
Фильтр заказывается отдельно

FILTER
 Pag. 221

HIGHLIGHTS

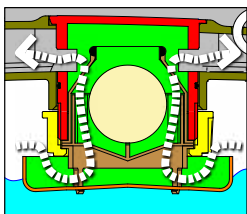

OPEN

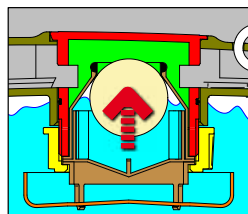

CLOSED



- Possibilità di chiusura con lucchetto (non fornito).
- Possibility to lock with padlock (not supplied).
- Возможность закрытия на замок (не входит в комплект).

DIMENSIONS

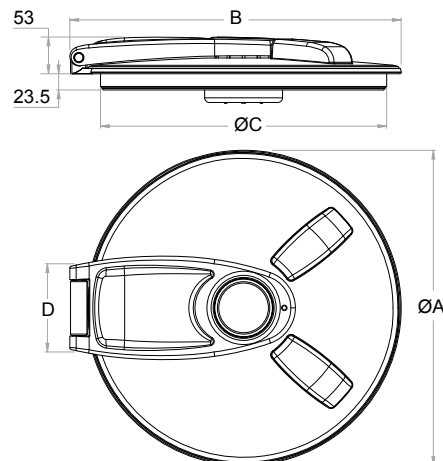

Set Coperchio + Anello.

Lid + Ring kit.

Комплект крышка+ кольцо

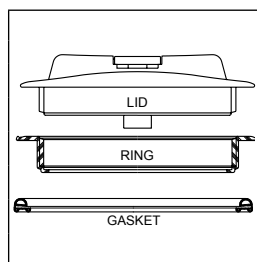

Part No.	Ø mm	LID	Configuration RING	GASKET	Pack
8149000	250	8146002	8148000	/	10
8149002	255	8146002	8148002	G00000001	10
8155001	350	8152004	8154000	/	10
8155006	350	8152004	8154002	G00000002	10
8161001	450	8158005	8160000	/	10
8161007	450	8158005	8160002	G00000003	10

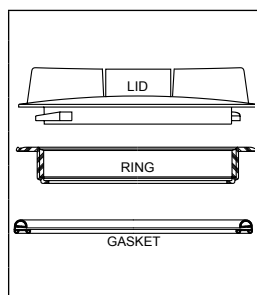

Part No.	Ø mm	LID	Configuration RING	GASKET	Pack
8155000	350	8152002	8154000	/	10
8155004	350	8152002	8154002	G00000002	10
8161000	450	8158002	8160000	/	10
8161005	450	8158002	8160002	G00000003	10
8167001	620	8164002	8166000	/	10
8167002	620	8164002	8166001	G00000044	10
8167003	620	8164000	8166001	G00000044	10

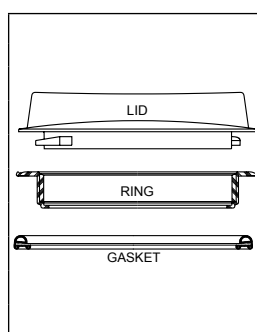

Part No.	Ø mm	LID	Configuration RING	GASKET	Pack
8143001	140	8140002	8142000	G00000000	10
8143002	140	8140003	8142000	G00000000	10
8149001	250	8146000	8148000	/	10
8155002	350	8152000	8154000	/	10
8155005	350	8152000	8154002	G00000002	10
8161002	450	8158000	8160000	/	10
8161003	450	8158000	8160002	G00000003	10
8167000	620	8164000	8166000	/	10

Ordinare filtro separatamente
Filter to be ordered separately
Фильтр заказывается отдельно



Coperchi per cisterne serie Manta con 1 sfianto a labirinto.

Tank lids Manta with 1 vent

Крышки для емкостей серии Manta с 1 лабиринтовым воздуховыпускным устройством

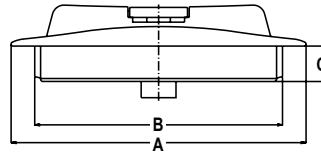

Part No.	A mm	B mm	C mm	BREATHER	Pack
8146002	250	210	31	1 LABYRINTH	10
8152004	350	313	29	1 LABYRINTH	10
8158005	450	408	23	1 LABYRINTH	10



Ordinare anello e filtro separatamente.
 Ring and filter to be ordered separately.
 Фильтр и кольцо заказываются отдельно.

FILTER



Pag. 221

RING



Pag. 220

Coperchi per cisterne serie Manta con 1 sfianto a molla.

Tank lids, Manta series, with 1 spring breather.

Крышки для емкостей серии Manta с 1 пружинным воздуховыпускным устройством.

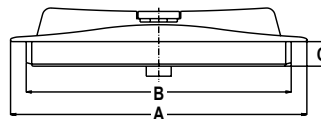

Part No.	A mm	B mm	C mm	BREATHER	Pack
8146001	250	210	31	1 SPRING VALVE	10



Ordinare anello e filtro separatamente.
 Ring and filter to be ordered separately.
 Фильтр и кольцо заказываются отдельно.

FILTER



Pag. 221

RING



Pag. 220

Coperchi per cisterne serie Manta chiusi.

Closed tank lids, Manta series

Закрытые крышки для емкостей серии Manta.

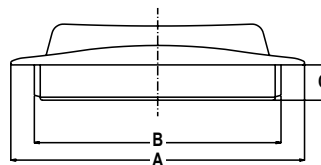

Part No.	A mm	B mm	C mm	BREATHER	Pack
8146000	250	210	31	CLOSED	10
8152000	350	313	29	CLOSED	10
8158000	450	408	23	CLOSED	10
8164000	611	559	28	CLOSED	10



Ordinare anello e filtro separatamente.
 Ring and filter to be ordered separately.
 Фильтр и кольцо заказываются отдельно.

FILTER



Pag. 221

RING



Pag. 220

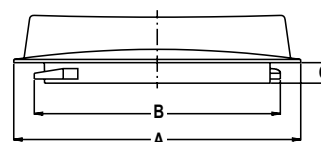

Part No.	A mm	B mm	C mm	BREATHER	Pack
8140000	140	120	8	CLOSED	10

Coperchi per cisterne serie Manta con 2 sfiati a labirinto.

Tank lids Manta with 2 vents.

Крышки для емкостей серии Manta с 2 лабиринтовыми воздуховыпускными устройствами.

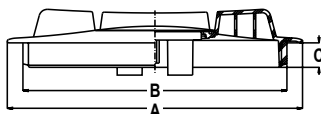

Part No.	A mm	B mm	C mm	BREATHER	Pack
8152002	350	313	29	2 LABYRINTH	10
8158002	450	408	23	2 LABYRINTH	10
8164002	611	559	26	2 LABYRINTH	10



Ordinare anello e filtro separatamente.
Ring and filter to be ordered separately.
Фильтр и кольцо заказываются отдельно.

FILTER



Pag. 221

RING



Pag. 220

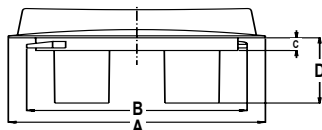

Part No.	A mm	B mm	C mm	D mm	BREATHER	Pack
8140002	140	120	8	52,5	2 LABYRINTH	10

Coperchi per cisterne serie Manta con sfiato a 4 labirinti.

Tank lids Manta with 4 vents.

Крышки для емкостей серии Manta с 4 лабиринтовыми воздуховыпускными устройствами.

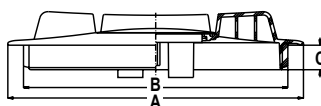

Part No.	A mm	B mm	C mm	BREATHER	Pack
8152003	350	313	29	4 LABYRINTH	10
8158003	450	408	23	4 LABYRINTH	10



Ordinare anello e filtro separatamente.
Ring and filter to be ordered separately.
Фильтр и кольцо заказываются отдельно.

FILTER



Pag. 221

RING



Pag. 220

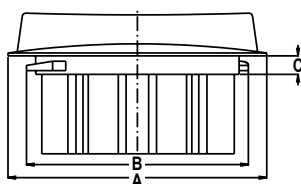

Part No.	A mm	B mm	C mm	D mm	BREATHER	Pack
8140003	140	120	8	52,5	4 LABYRINTH	10

Coperchi per cisterne serie Manta con 2 sfiami a molla.

Tank lids, Manta series, with 2 spring breather.

Крышки для емкостей серии Manta с 2 пружинными воздуховыпускными устройствами.

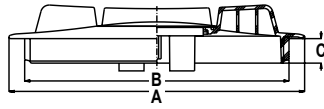

Part No.	A mm	B mm	C mm	BREATHER	Pack
8152001	350	313	29	2 SPRING VALVE	10
8158001	450	408	23	2 SPRING VALVE	10



Ordinare anello e filtro separatamente.
 Ring and filter to be ordered separately.
 Фильтр и кольцо заказываются отдельно.

FILTER



Pag. 221

RING



Pag. 220

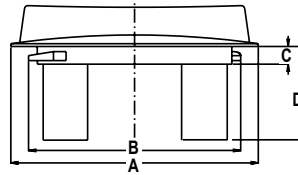

Part No.	A mm	B mm	C mm	D mm	BREATHER	Pack
8140001	140	120	8	52,5	2 SPRING VALVE	10



RINGS

Anelli per coperchi serie Manta.

Rings for tank lids (Manta series).

Кольца для крышек серии Manta.

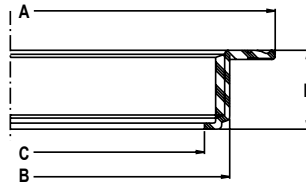

Part No.	A mm	B mm	C mm	L mm	FIXING	Pack
8148000	262	217	192	39	FLAT SURFACES	10
8154000	357	320	290	38		
8160000	457	415	382	35		
8166000	617	567	536	40,5		

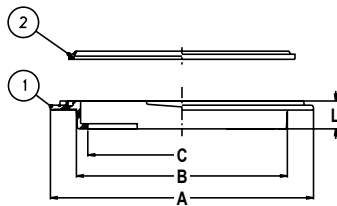

Part No. 1	Part No. 2	A mm	B mm	C mm	L mm	FIXING	Pack
8142000	G00000000	154	125	112	17	FLAT SURFACES	10

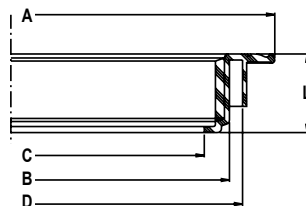

Part No.	A mm	B mm	C mm	L mm	D mm	FIXING	Pack
8148001	262	217	192	39	230	SIDE CONNECTION	10
8154001	357	320	290	38	335		
8160001	457	415	382	35	430		

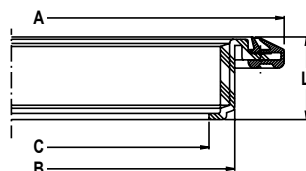

Part No.	A mm	B mm	C mm	L mm	GASKET	FIXING	Pack
8148002	265	217	192	39	G00000001	FLAT SURFACES c/w GASKET	10
8154002	368	320	290	38	G00000002		
8160002	463	415	382	35	G00000003		
8166001	612	567	536	35	G00000044		

FILTERS

Cestelli per coperchi serie Manta e Abat (18 Mesh).

Basket filters for tank lids Manta and Abat series (18 Mesh).

Корзинчатые фильтры для крышек серии Manta и Abat (18 меш).

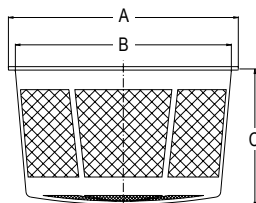

Part No.	A mm	B mm	C mm	Pack	SUITABLE FOR RINGS	SUITABLE FOR TANK LIDS
8147000	201	189	50			
8147001	201	189	120	25	8148xxx	
8147002	201	189	240			
8153000	301	287	60			
8153001	301	287	240	25	8154xxx	8169xxx
8159000	400	380	180	20		
8159001	400	380	280	20	8160xxx	8170xxx
8159002	400	380	320	15		

OPTIONALS



Hydraulic powered mixers Pag. 227

Cestelli in acciaio Inox per coperchi serie Manta.

Stainless Steel basket filters for Manta series tank lids.

Корзинчатые фильтры из нерж.стали для крышек серии Манта.

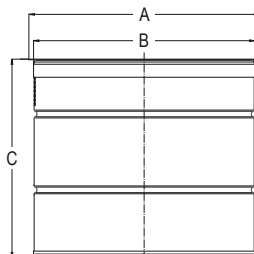

INOX

Part No.	A mm	B mm	C mm	Pack	SUITABLE FOR RINGS	SUITABLE FOR TANK LIDS
8159008	395	379	340	1	8160xxx	8170xxx

GASKETS

Guarnizioni esterne per anelli.

External gasket for rings.

Наружные прокладки для колец.

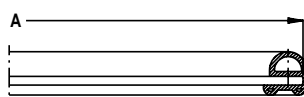

Part No.	RINGS	A mm	Pack
G0000001	8148002	255	10
G0000002	8154002	350	10
G0000003	8160002	460	10
G0000004	8166001	612	10

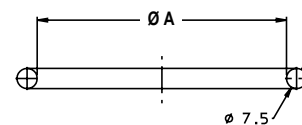

Part No.	RINGS	TANK LIDS	A mm	Pack
G0000006	8154000	8169xxx	285	10
G0000007	8160000	8170xxx	370	10
G0000010	8142000		105	10
G0000011	8148000		190	10
G0000028	8166000		505	10

Coperchio filettato femmina per serbatoi.
 Standard in colore nero

Female threaded tank lids.
 Standard black color.

Крышка с внутренней резьбой для емкостей.
 Стандартная черного цвета.

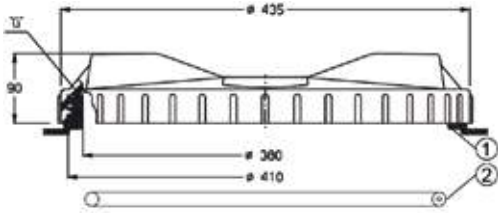

Part No. 1	Part No. 2	BREATHER	Pack
8178002	G00000007	CLOSED	10

OPTIONALS

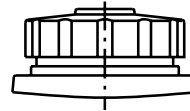

Part No.		Pack
8367000	VALVE	10

Coperchio filettato femmina chiuso senza guarnizione di serie.

Closed female threaded cover. It does not feature a gasket.

Закрытая крышка с внутренней резьбой без прокладки в серийной комплектации.

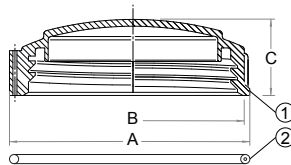

Part No. 1	Part No. 2	TYPE	A mm	B mm	C mm	Pack
8178000	G00001066	○	172	6"	56	10

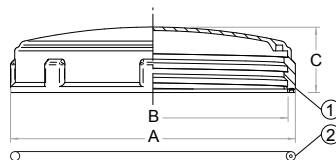

Part No. 1	Part No. 2	TYPE	A mm	B mm	C mm	Pack
8178011	G00000012	□	122	113	31	10
8178004	G00001075	○	240	226	55	10

Coperchio filettato femmina con sfianto a molla senza guarnizione di serie.

Female threaded cover with breather spring. It does not feature a gasket.

Крышка с внутренней резьбой с пружинным воздуховыпускным устройством без прокладки в серийной комплектации.

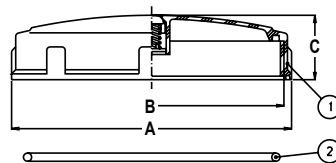

Part No. 1	Part No. 2	TYPE	A mm	B mm	C mm	Pack
8178012	G00000012	□	122	113	31	10
8178001	G00001066	○	172	6"	56	10
8178006	G00001075	○	240	226	55	10

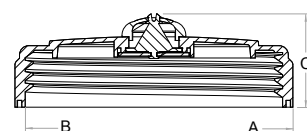

Part No.	A mm	B mm	C mm	BREATHER	Pack
8178019	122	113	41	DIAPHRAGM	10

Coperchio filettato femmina da completare con valvola di sfiato in EPDM e guarnizione fornita a parte.

Female threaded cover to be completed with breather valve in EPDM and gasket supplied separately.

Крышка с внутренней резьбой, комплектуемая воздуховыпускным клапаном из EPDM и предоставляемой отдельно прокладкой.

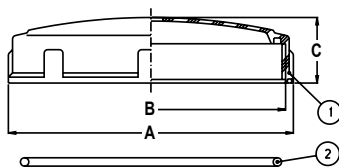

Part No. 1	Part No. 2	TYPE	A mm	B mm	C mm	Pack
8178005	G00001075	○	240	226	55	10

Valvola in EPDM.

EPDM air valve.

Клапан из EPDM.

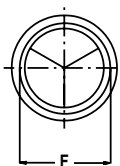

Part No.	F mm	Pack
V00101000	33	25
V00101002	33	25

Coperchio filettato femmina, con sfiato a molla, con guarnizione di serie.

Female threaded cover with breather spring and gasket.

Крышка с внутренней резьбой с пружинным воздуховыпускным клапаном с прокладкой в серийной комплектации.

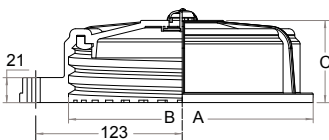
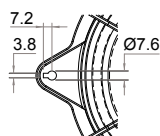

Part No.	A mm	B mm	C mm	BREATHER	Pack
8178018	220	180	69	DIAPHRAGM	10

SPARE PARTS

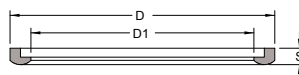

Part No.	D mm	D1 mm	S mm	Pack
G00000048	178	150	6	10

Coperchio filettato chiuso. Con guarnizione di serie.

Closed threaded cover. Gasket included.

Закрытая крышка с резьбой. С прокладкой в серийной комплектации.

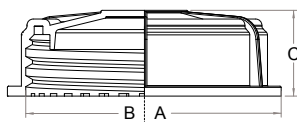

Part No.	A mm	B mm	C mm	Pack
8178016	220	180	69	10

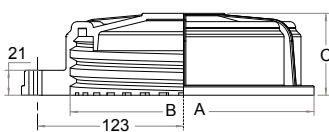
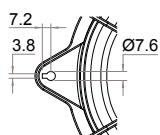

Part No.	A mm	B mm	C mm	Pack
8178017	220	180	69	10

SPARE PARTS

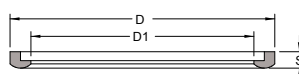

Part No.	D mm	D1 mm	S mm	Pack
G00000048	178	150	6	10

Coperchio filettato chiuso.
Senza guarnizione di serie.

Closed threaded cover.
It does not feature a gasket.

Закрытая крышка с резьбой.
Без прокладки в серийной комплектации.

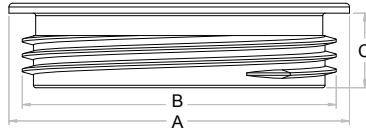

Part No.	A mm	B mm	C mm	Pack
8180000	137	126	30	10

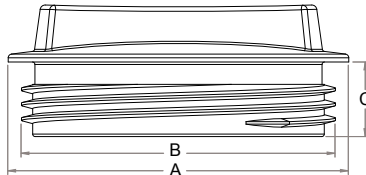

Part No.	A mm	B mm	C mm	Pack
8180001	137	126	30	10



Per completare, ordinare la guarnizione.
To complete, please order the gasket.
Для комплектации заказать прокладку.

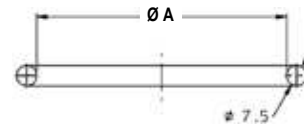

Part No.	A mm	Pack
G00000046	112	10

Coperchio filettato chiuso.
Senza guarnizione di serie.

Closed threaded cover. It does not feature a gasket.

Закрытая крышка с резьбой. Без прокладки в серийной комплектации.

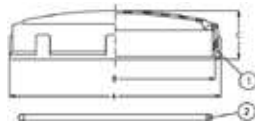

Part No. 1	A mm	B mm	C mm	Pack
8178015	122	113	31	10
8178014 gasket included	122	113	31	10



Per completare, ordinare la guarnizione.
To complete, please order the gasket.
Для комплектации заказать прокладку.

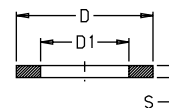

Part No. 2	D mm	D1 mm	S mm	Pack
G00000012	106	89	5	10

Coperchi per serbatoi lavamani con disco di sfianto antisbattimento

Caps for handwash tanks with anti-rattling exhaust disk

Крышки для емкостей для мытья рук с воздуховыпускным диском

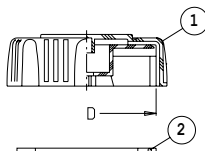

Part No. 1	Part No. 2	TYPE	D mm	BREATHER	Pack
8178007	G00002036	<input type="checkbox"/>	60	LABYRYNTH	10
8178008	G00002037	<input type="checkbox"/>	80	LABYRYNTH	10

Valvola di ritegno, filetti Maschio e Femmina.

Non-return valve, Male and Female threaded.

Обратный клапан, внутренняя и наружная резьба.

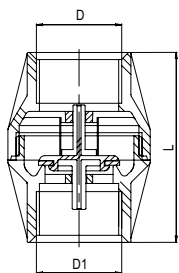

Part No.	D BSP	D1 BSP	bar	L mm	Pack	MAX
8206000	G 1¼ F	G 1¼ F	6	94	10	
8206001	G 1½ F	G 1½ F	6	94		
8206006	G 1½ F	G 1¼ F	6	96		
8206004	G 2 F	G 2 F	4	96		

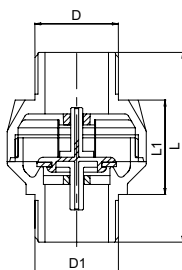

Part No.	D BSP	D1 BSP	bar	L mm	Pack	MAX
8206002	G 1¼ M	G 1¼ M	6	94	10	
8206003	G 1½ M	G 1½ M	6			
8206005	G 2 M	G 2 M	4			

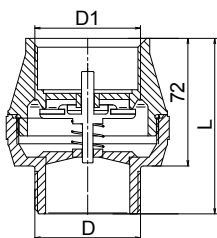

Part No.	D BSP	D1 BSP	bar	L mm	Pack	MAX
8206007	G 2 M	G 2 F	4	99	10	

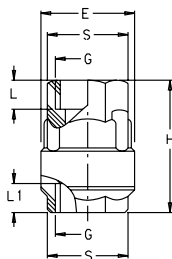





Part No.	G	E mm	H mm	L mm	L1 mm	S mm	bar	Pack	MAX
8369000	G 1/2	40	62	16	16	27	10	20	
8369001	G 3/4	47	68	17	17	34	10	20	
8369002	G 1	57	75	17	18	41	10	20	

Lavaserbatoi rotante.

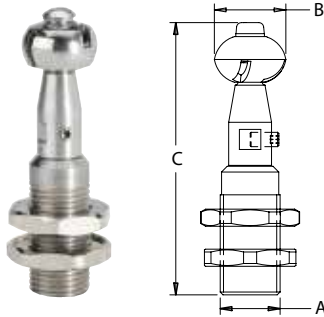
Tank rinsing head.



Вращающаяся моечная головка емкостей.



TYPE	FEATURES	
	 bar	 1/1"
	5	13,5
	7,5	15,5
	10	18

Part No.	Angle	A	B mm	C mm	bar	Pack
8185005	240°	G 1/4 M	25	60	10	5
8185003	360°	G 1/4 M	25	60	10	

Part No.	Angle	A	B mm	C mm	bar	Pack
8185000	240°	G 1/2 M	25	95	10	5
8185006	360°	G 1/2 M	25	95	10	

TYPE	FEATURES	
	 bar	 1/1"
	5	24
	7,5	29
	10	34

Valvola per lava barattolo

Rinsing head valve

Клапан моечной головки

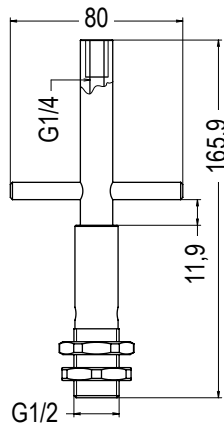

Part No.	bar	Pack
8185004	10	5

ASSEMBLY

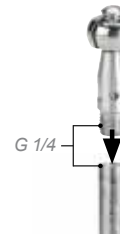

NEW

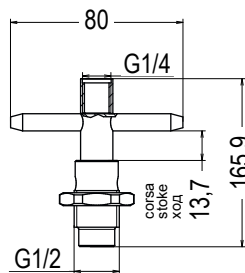

Part No.	bar	Pack
8185008	10	5

ASSEMBLY

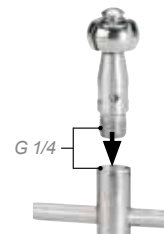

Testa rotante lavaserbatoi.

Viene azionata dal fluido, garantendo un lavaggio effettivo a 360°.
 Per un corretto fissaggio si consiglia di utilizzare il kit K00107002.

Rotational spray head

This tank rinsing nozzle has a fluid-driven rotational spray head which provides 360° coverage inside the surface of the tank.
 For an accurate coupling, the use of the KIT Ref. K00107002 is highly recommended.

Вращающаяся моечная головка

Активируется жидкостью, гарантируя эффективную мойку на 360°.
 Для соответствующего крепления рекомендуется использовать комплект K00107002.

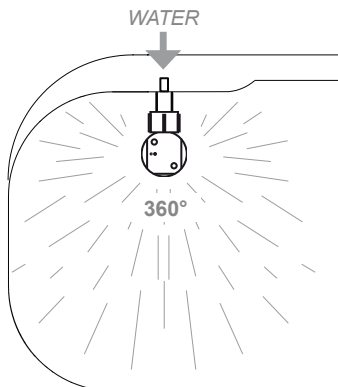
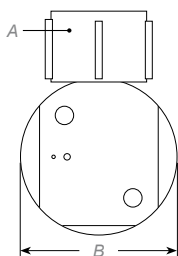

FEATURES

bar	l/1'
2	14
3	18
4	22

Part No.	Angle	A	B mm	bar	Pack
8185007	360°	G1	64	4	5

OPTIONALS



Part No.	Ø	Pack
K00107002	G1	5

Miscelatore idraulico per polveri in polipropilene o inox.

S/S or polypropilene hydraulic powered mixer.

Гидравлический порошковый смеситель из полипропилена или нержавеющей стали.



Part No.	Material	IN	Pack
8199001	INOX	G 1/2 M	10

Part No.	Material	IN	Pack
8199000	PP	G 1/2 M	10

ASSEMBLY

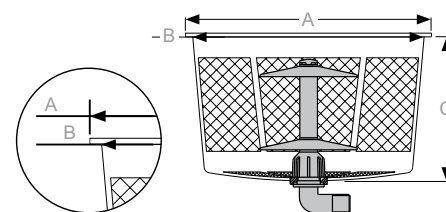

Valvola di scarico dall'alto da 3".
 Molla in acciaio inox.

Cable drain valve 3".
 S/S spring.

Кабельный сливной клапан 3".
 Пружина из нержавеющей стали.



Fino ad esaurimento
 Selling out
 до окончания складских запасов

Part No.	Pack
8203000	5

ASSEMBLY



Agitatore idraulico ispezionabile.

Easy-to-check swivel hydraulic stirrer.

Гидравлический смеситель
возможностью инспекции.

c



Part No.	NOZZLES mm	MATERIAL	IN	Pack
8201017	Ø 2	INOX	G 1/2"	5

Part No.	NOZZLES mm	MATERIAL	IN	Pack
8201018	Ø 2	INOX	G 1/2"	5
8201019	Ø 1,25	INOX	G 1/2"	

Linea continua: portata totale. Linea tratteggiata: portata dell'ugello.
Unbroken line: total flow rate. Dashed line: nozzle flow rate.
Непрерывная линия: общий расход. Пунктирная линия: расход форсунки.

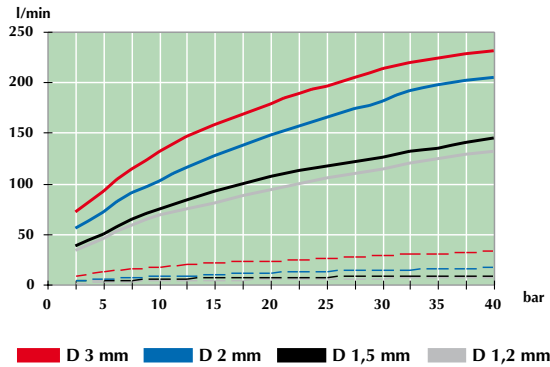

Agitatore idraulico ispezionabile.

Easy-to-check swivel hydraulic stirrer.

Гидравлический смеситель
возможностью инспекции.

c



Part No.	NOZZLES mm	MATERIAL	IN	FLY NUT	Pack
8201000	Ø 1,2	CERAMIC	G 1/2"	G 1" 1/4	5
8201001	Ø 1,5	CERAMIC	G 1/2"	G 1" 1/4	
8201002	Ø 2	CERAMIC	G 1/2"	G 1" 1/4	
8201003	Ø 3	CERAMIC	G 1/2"	G 1" 1/4	

Part No.	NOZZLES mm	MATERIAL	IN	FLY NUT	Pack
8201004	Ø 1,2	CERAMIC	G 1/2"	G 1" 1/4	5
8201005	Ø 1,5	CERAMIC	G 1/2"	G 1" 1/4	
8201006	Ø 2	CERAMIC	G 1/2"	G 1" 1/4	
8201007	Ø 3	CERAMIC	G 1/2"	G 1" 1/4	

Linea continua: portata totale. Linea tratteggiata: portata dell'ugello.
Unbroken line: total flow rate. Dashed line: nozzle flow rate.
Непрерывная линия: общий расход. Пунктирная линия: расход форсунки.

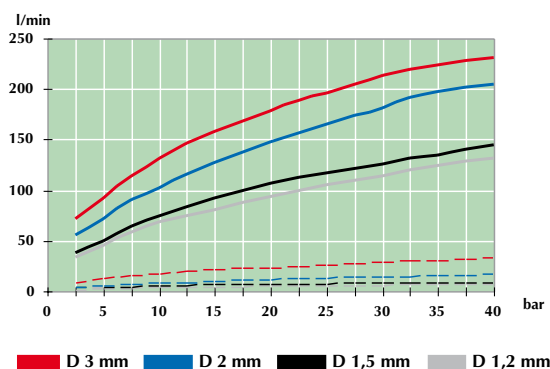

Agitatore idraulico orientabile.

Swivel hydraulic stirrer.

Гидравлический
 смеситель.

поворачиваемый



Part No.	NOZZLES mm	MATERIAL	Pack
8201010	Ø 2	CERAMIC	3
8201011	Ø 3	CERAMIC	
8201012	Ø 5	INOX	

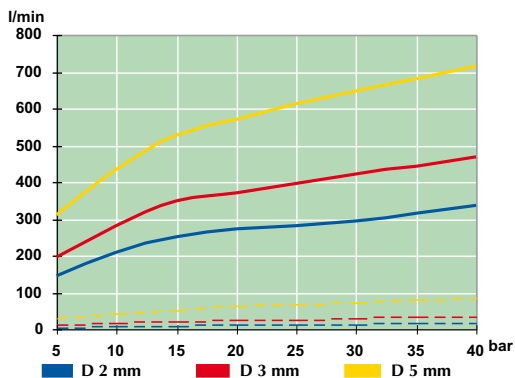

Linea continua: portata totale. Linea tratteggiata: portata dell'ugello.

Unbroken line: total flow rate. Dashed line: nozzle flow rate.

Непрерывная линия: общий расход. Пунктирная линия: расход форсунки.

DIMENSIONS

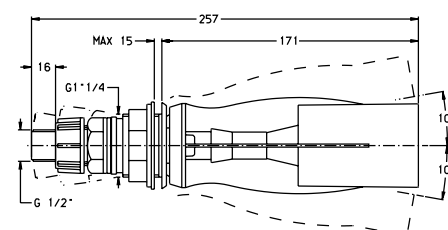

Agitatore idraulico in ottone completo di filtro
 - ingresso G 1/2"
 - foro parete ø 22 mm

Brass hydraulic stirrer
 - BSP1/2" inlet
 - wall hole ø 22 mm

Гидравлический латунный смеситель в
 комплекте с фильтром
 - вход 1/2" G
 - отверстие стены ø 22 mm



Part No.	NOZZLE mm	Pack
8201013	Ø 1,2	20
8201014	Ø 1,5	
8201015	Ø 2	
8201016	Ø 3	

DIMENSIONS

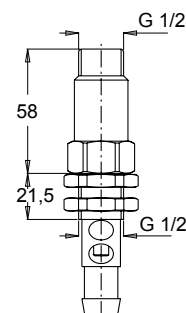

Idroiettoire orientabile (senza raccordo di aspirazione).

Swivel ejector (without a suction fitting).

Поворачиваемый гидравлический эжектор (без всасывающего соединения).



Part No.	NOZZLES mm	bar	Pack
8197007	Ø 3	10+35	10
8197008	Ø 5		

DIMENSIONS



Grafico ottenuto con una prevalenza di 2 m e tubo di aspirazione Ø 30 mm.
 Linea continua: portata totale. Linea tratteggiata: portata dell'ugello.

Test conditions: 2 mt head and Ø 30 mm suction pipe.
 Unbroken line: total flow rate. Dashed line: nozzle flow rate.

График получен с высотой напора 2 м и всасывающей трубой Ø 30 мм.
 Непрерывная линия: общий расход. Пунктирная линия: расход форсунки.

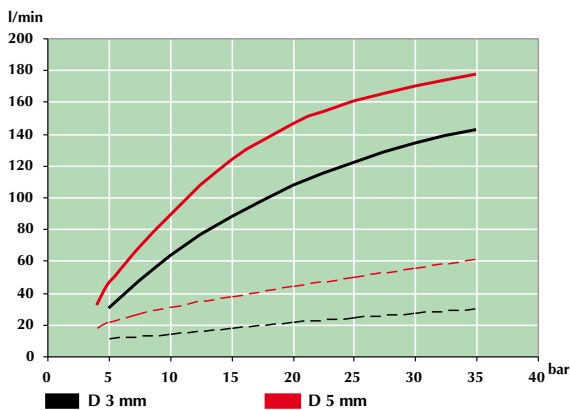
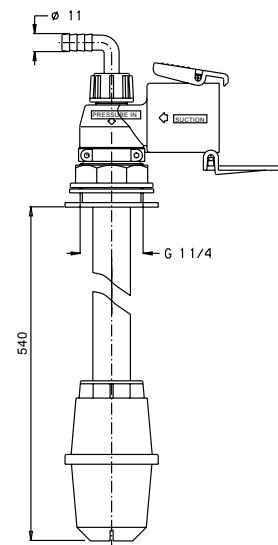

Raccordo di aspirazione: da ordinare separatamente
 Suction fitting: to be ordered separately
 Всасывающее соединение: заказывается отдельно

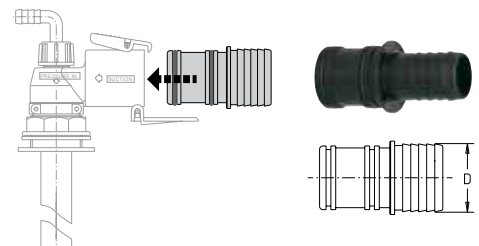

Part No.	D mm	Pack
K00002000	25	10
K00002001	30	10
K00002002	35	10
K00002003	40	10

Antivortice

Antivortex

Антивихрь

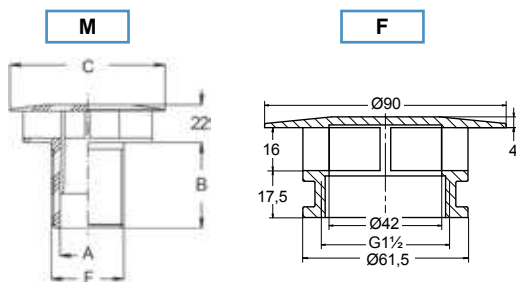

Part No.	F	A mm	B mm	C mm	Pack
8209005	G1½ M	32	50	90	
8209006	G1½ M	38	50	90	
8209007	G1½ F	42	17,5	90	25
8209008	G2 M	56	60	118	
8209009	G1 M	25	50	90	

Valvola di sfiato a labirinto.

Labyrinth breather valve.

Лабиринтовый воздуховыпускной клапан.



Part No.	F	BREATHER	Pack
8208000	G1 M	COMPLETE	50
8208001	G1 M	WITHOUT NUT	

Protezione foglie per gruppi ventola montati su atomizzatori con viti per il fissaggio.

Leaf protection for atomizers with fixing screws.

Защитное приспособление от листьев для вентиляторных блоков, монтированных на распылителях с крепежными винтами.



Part No.	Pack
8316002	5

Caricabotte inox

Stainless steel ejector

Эжектор из нержавеющей стали

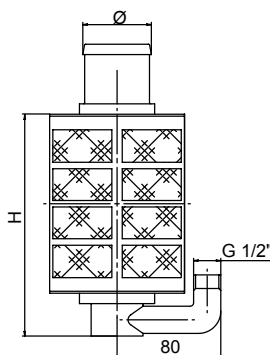

Part No.	Ø mm	H mm	Screen MESH	Pack
8197005	30	173	50	
8197006	40	173	50	6
8197011	50	173	50	

Flangia per atomizzatori in ottone con guarnizione in EPDM.

Brass sprayer flange with EPDM joint.

Фланец для распылителей из латуни с прокладкой из EPDM.

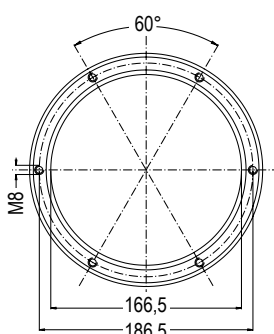

Part No.	Pack
8195000	10

Rubinetti per serbatoi lavamani

Taps for handwash tanks

Краны для баков для мытья рук

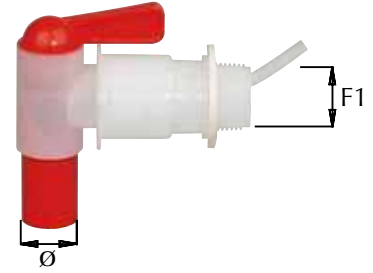

Part No.	F1	Ø mm	bar	Pack
8365000	3/4"	8	0,5	50

Part No.	F1	Ø mm	bar	Pack
8365001	3/4"	18	0,5	50

Part No.	F1	Ø mm	bar	Pack
8365002	3/4"	18	0,5	50

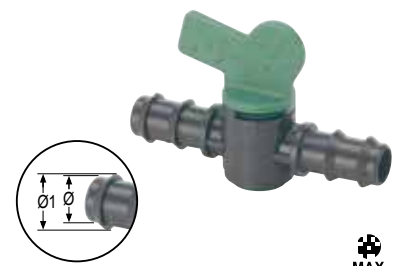
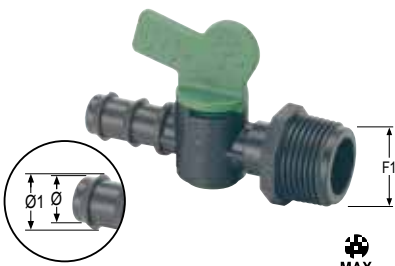

Part No.	F1	Ø mm	Ø1 mm	bar	Pack
8365003	1/2"	13	16	5	50
8365004	1/2"	16	19	5	
8365005	3/4"	13	16	5	
8365006	3/4"	16	19	5	

Part No.	F1	bar	Pack
8365007	1/2" x 1/2"	5	50
8365008	3/4" x 3/4"	5	

Part No.	Ø mm	Ø1 mm	bar	Pack
8365009	10 - 10	11	5	50
8365010	13 - 13	16	5	
8365011	16 - 16	19	5	

Raccordo a tre vie per miscelatore.

Mixer 3-way fitting.

Трехходовой фитинг для смесителя.



Part No.	D mm	l/1'	bar	Pack
8199006	5	20+50	2+15	5
8199007	7	50+100	4+15	
8199008	9	100+150	7+15	
8199009	12	150+250	4+15	

DIMENSION

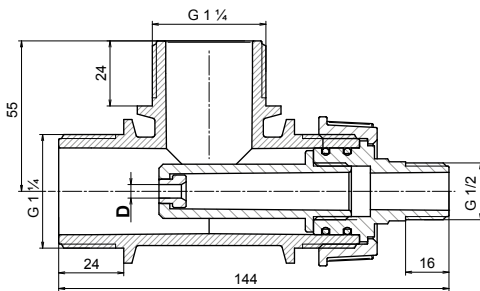

ASSEMBLY

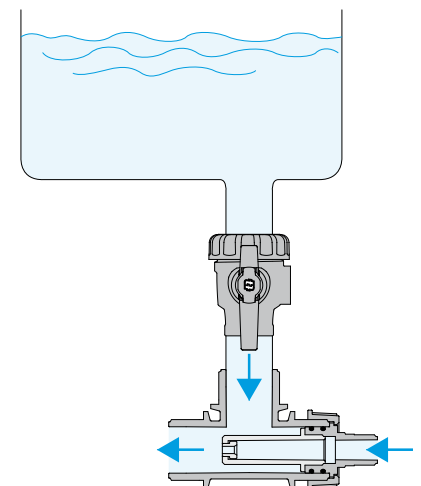

GeoDry



Il misuratore di livello meccanico **GeoDry** permette una facile e precisa lettura del livello durante la guida.

Grazie al sistema di rinvio a carrucola, la condizione di cisterna vuota (riserva) viene mostrata nella parte superiore della scala graduata, per una facile ed immediata lettura.

Costruito in acciaio inox e propilene, **GeoDry** è particolarmente indicato anche per impieghi con liquidi fortemente aggressivi e densi.

Dotato di scala di lettura "neutra", da personalizzare in funzione della capacità del serbatoio su cui viene installato, è adatto per cisterne profonde fino a 3 metri.

Viene fornito parzialmente assemblato e dotato di kit per l'installazione.

The mechanical level indicator **GeoDry** allows an easy and precise reading of the level while driving.

Thanks to the counter pulley system, the condition of empty tank is shown in the upper part of the scale, for easy and immediate reading.

Built in stainless steel and polypropylene, **GeoDry** is extremely suitable for applications with dense and highly corrosive liquids.

Equipped with a "neutral" reading scale, to customize according to the capacity of the tank on which is installed, it is suitable for tanks up to 2 meters deep.

Comes partially assembled and fitted with a kit for the installation.

Механический уровневый индикатор **GeoDry** обеспечивает удобное и точное считывание параметров при вождении.

Благодаря обратной системе шкивов, состояние пустой емкости (резерв) отображается в верхней части градуированной шкалы, в целях удобного и незамедлительного снятия параметров.

Изготовленный из нержавеющей стали и пропилен **GeoDry** предназначен также для применения с сильно агрессивными и плотными жидкостями.

Оснащен "нейтральной" шкалой считывания, может быть персонализирован в зависимости от объема емкости, на которой он установлен, пригоден для емкостей глубиной до 2 метров. Поставляется в частично собранном виде и оснащен монтажным комплектом

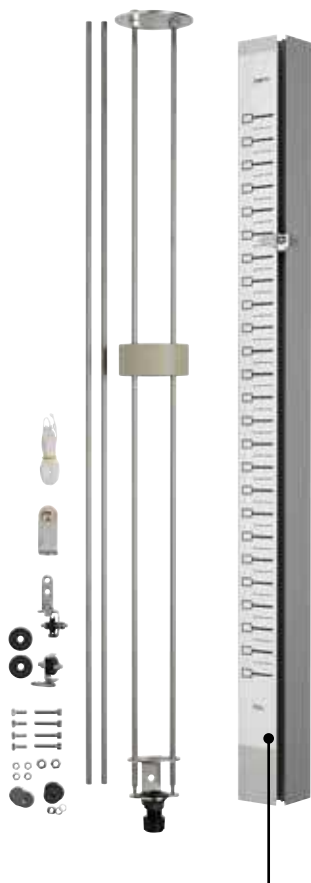

Scala graduata personalizzabile, con zona RISERVA nella parte superiore

Personalized scale, with RESERVE area on the top

Персонализируемая градуированная шкала, с зоной РЕЗЕРВА в верхней части

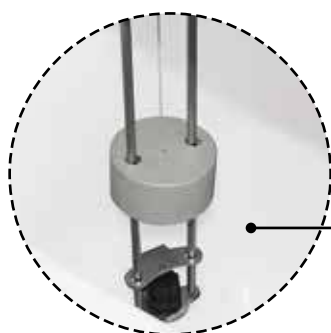

interno cisterna

internal part of the tank
внутренняя часть емкости



Part No.	mm	Pack
8212009	2000	1
8212010	3000	1

Campo di impiego
Use / Применение



KIT

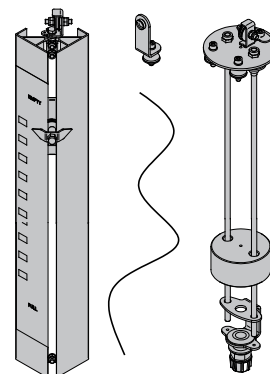

INSTALLATION

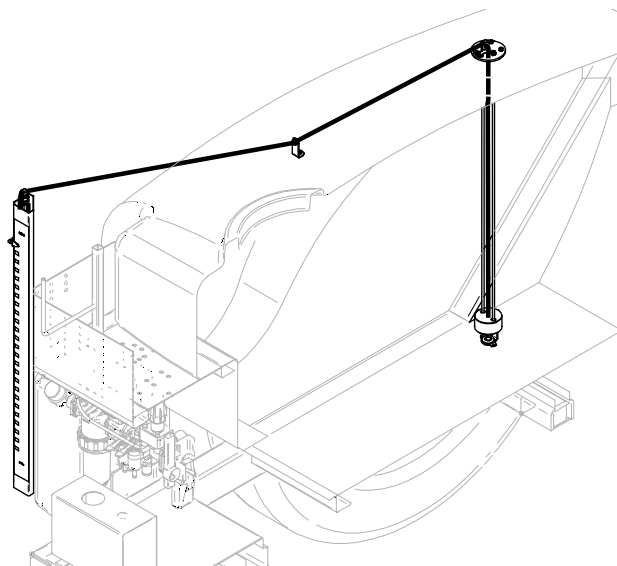

GeoDry



Il misuratore di livello meccanico **GeoDry** permette una facile e precisa lettura del livello durante la guida.

Grazie al sistema di rinvio a carrucola, la condizione di cisterna vuota (riserva) viene mostrata nella parte superiore della scala graduata, per una facile ed immediata lettura.

Costruito in acciaio inox e propilene, **GeoDry** è particolarmente indicato anche per impieghi con liquidi fortemente aggressivi e densi.

Dotato di scala di lettura "neutra", da personalizzare in funzione della capacità del serbatoio su cui viene installato, è adatto per cisterne profonde fino a 1,5 metri.

Viene fornito parzialmente assemblato e dotato di kit per l'installazione.

The mechanical level indicator **GeoDry** allows an easy and precise reading of the level while driving.

Thanks to the counter pulley system, the condition of empty tank is shown in the upper part of the scale, for easy and immediate reading.

Built in stainless steel and polypropylene, **GeoDry** is extremely suitable for applications with dense and highly corrosive liquids.

Equipped with a "neutral" reading scale, to customize according to the capacity of the tank on which is installed, it is suitable for tanks up to 2 meters deep.

Comes partially assembled and fitted with a kit for the installation.

Механический уровневый индикатор **GeoDry** обеспечивает удобное и точное считывание параметров при вождении.

Благодаря обратной системе шкивов, состояние пустой емкости (резерв) отображается в верхней части градуированной шкалы, в целях удобного и незамедлительного снятия параметров.

Изготовленный из нержавеющей стали и пропилен **GeoDry** предназначен также для применения с сильно агрессивными и плотными жидкостями.

Оснащен "нейтральной" шкалой считывания, может быть персонализирован в зависимости от объема емкости, на которой он установлен, пригоден для емкостей глубиной до 2 метров. Поставляется в частично собранном виде и оснащен монтажным комплектом

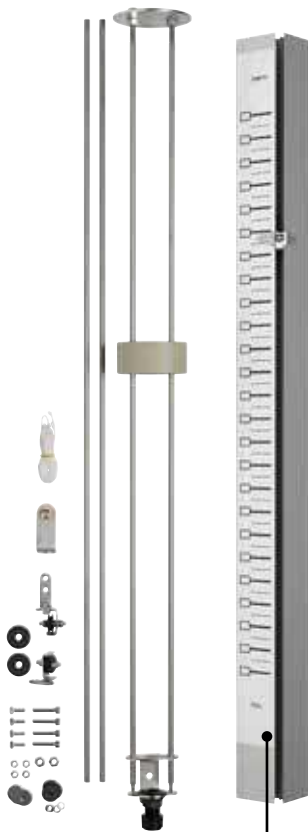

Scala graduata personalizzabile, con zona RISERVA nella parte superiore

Personalized scale, with RESERVE area on the top

Персонализируемая градуированная шкала, с зоной РЕЗЕРВА в верхней части

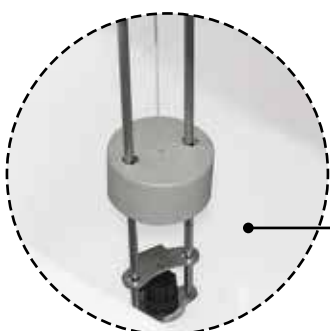

interno cisterna

internal part of the tank
внутренняя часть емкости



Part No.	mm	Pack
8212011	1500	1

Campo di impiego Use / Применение



KIT

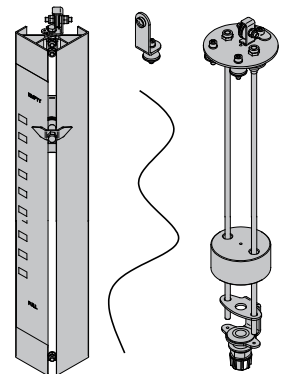

INSTALLATION

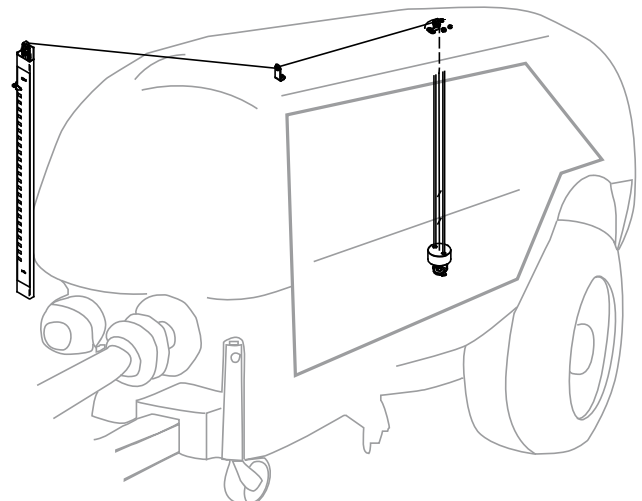

Indicatore di livello con galleggiante (senza scala graduata).

Tank level indicator with float (without graduated scale).

Уровневый индикатор с поплавком (без градуированной шкалы).



Part No.	Pack
8212000	5

KIT



Indicatore di livello + Galleggiante
Tank level indicator + Float
Уровн.индикатор + Поплавок

OPTIONALS

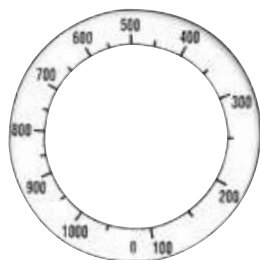

Part No.	Range	Pack
8212001	Neuter	5
8212002	0 ÷ 1000	5
8212003	0 ÷ 1500	5
8212004	0 ÷ 2000	5

Scala graduata
Graduated scale
Градуированная шкала

INSTALLATION



Non compreso nel kit
Not included
Не входит в комплектацию

Indicatore di livello esterno, completo di tubo.

Tank level indicator including tube.

Внешний уровневый индикатор в комплектации с трубой.



L = 1,5 m

Non compreso nel kit
Not included
Не входит в комплектацию

Part No.	Pack
8212005	5

GeoMix 4



Lavacontenitori di fitofarmaci con comando di sicurezza.
 Cisterna in polietilene da 40 l.
 Oblò per ispezione miscelatore.
 Adattabile ad ogni tipo di macchina da diserbo.

- Cisterna in polietilene con oblò di controllo;
- Lavabarattoli con apertura di sicurezza a pressione;
- Ugelli in ceramica per miscelazione;
- Getto rotante lavabotte premix;
- Comando getto rotante lavabotte;
- Comando miscelazione;
- Comando eiettore per incorporazione in cisterna;
- Rete di protezione in plastica.

*Phytosanitary product container washing unit with safety control.
 40-litre polyethylene tank.
 Mixer inspection window.
 Adaptable to any type of spraying machine.*

- Tank in rotational polyethylene with transparent control cover;
- Container washer with pressure operated safety valve;
- Ceramic mixer nozzles;
- Rotating nozzle for cleaning internal surfaces;
- Rotating nozzle for internal cleaning lever control;
- Mixer control;
- Injector / transfer control;
- Protective grill in plastic.

*Моечный блок емкостей фитосанитарных средств с защитной системой управления.
 Полиэтиленовая емкость 40 л.
 Смотровое отверстие для инспекции смесителя.
 Пригоден для любых штанговых опрыскивателей.*

- Полиэтиленовая емкость с контрольным смотровым отверстием;
- Моечный блок емкостей с системой открытия давлением;
- Керамические форсунки для смешивания;
- Вращательная форсунка для мойки емкостей;
- Устройство управления вращательной форсунки;
- Устройство управления смешиванием;
- Устройство управления ежектором для встраивания в емкость;
- Защитная пластиковая сетка.

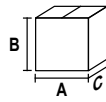

Part No.	Color	I	bar	A mm	B mm	C mm	kg	Pack
1 8199018								
1 8199020		40	15	504	632	399	15	1
1 8199021								
1 8199023								
NEW 2 8199027		25	15	509	544	399	13	1

DIMENSIONS

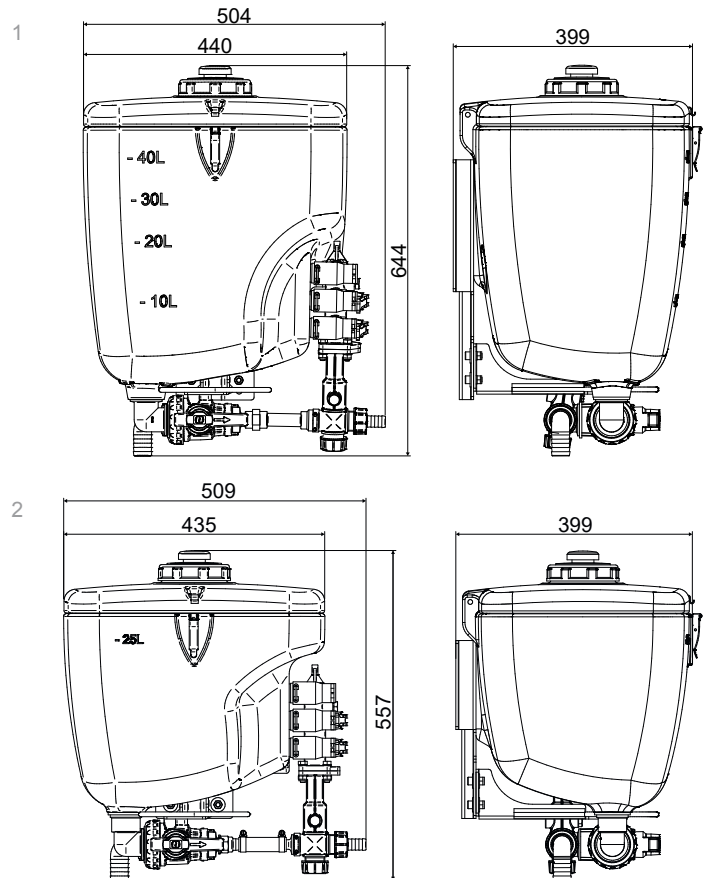

CERTIFICATION



OPTIONAL

GeoMix 4

Supporto a parallelogramma (manuale).

Parallelogram support (manual).

Параллелограммый суппорт (ручной)



Part No.	L mm	H mm	kg	Pack
8199019	240	480	10,8	1

DIMENSIONS

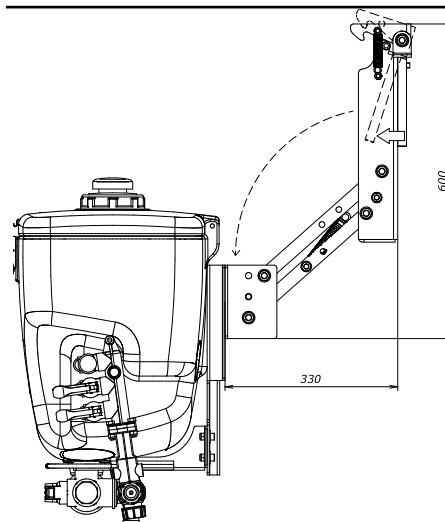

OPTIONAL

GeoMix 4

Kit di aspirazione per prodotti chimici in polvere prelevati direttamente dal contenitore. Adatto per GeoMix4.

Suction kit for powdered chemical products drawn directly from the container. Suitable to GeoMix4.

Комплект для всасывания порошковых химических продуктов, забор которых производится непосредственно из емкости. Предусмотрен для GeoMix4.



Part No.	HOSE LENGTH mm	Pack
K00112006	1500	1

LEGENDA

Campo di impiego / Use / Применение



Per macchine a basso volume
For low-volume spraying machines
Для малообъемных опрыскивателей



Per atomizzatori
For orchard sprayers
Для опрыскивателей



Per macchine da diserbo
For crop sprayers
Для штанговых опрыскивателей

Caratteristiche / Features / Характеристики



Portata
Flow rate
Расход



Pressione d'esercizio
Operating pressure
Рабочее давление



Per testine attacco rapido
For quick fitting caps
Для головок с фитингом быстрой установки

FEATURES



Prodotti non per uso alimentare
Products not for food use
Не годится для пищевых продуктов



60°C

MAX

Temperatura massima
Max temperature
Максимальная температура

Accessori opzionali

Optionals

Дополнительные аксессуары



Testine serraugello
Nozzle caps
Головки форсунок



Ugelli
Nozzles
Форсунки



Fascette di montaggio per DRY BOOM
DRY BOOM mounting clamps
Монтажные скобы для DRY BOOM

Ugelli e portaugelli

Tutti i portaugelli GEOLINE hanno struttura in nylon 66, guarnizioni in EPDM o VITON® e particolari metallici interni in acciaio inox AISI 304

Portaugelli

- Corpo i Nylon ad alta resistenza
- Membrana in EPDM, o in Viton®
- Valvola antigoccia tarata a 0,5 bar (a richiesta 0.2; 0.3; 1.0; 1.8 bar)

Testine attacco rapido

- Disponibili in una vasta gamma di colori
- Guarnizioni interne in EPDM, a richiesta in Viton®.

Nozzles and nozzle holders

All GEOLINE nozzle holders have a nylon 66 structure.

They are equipped with EPDM gaskets (VITON® on demand) and AISI 304 stainless steel internal parts.

Nozzle holders

- Nylon body
- Rubber diaphragm in EPDM or Viton®
- Diaphragm check valve calibrated to 0.5 bar (0.2; 0.3; 1.0; 1.8 bar on demand)

Quick caps

- available in a wide range of colours
- EPDM gaskets; Viton® on demand

Форсунки и форсункодержатели

Все форсункодержатели GEOLINE из нейлона 66.

Прокладки из EPDM (VITON® по заявке), внутренние детали из нержавеющей стали AISI 304.

Форсункодержатели

- Высокопрочный нейлоновый корпус
- Мембрана из EPDM или Viton®
- Обратный мембранный клапан 0.5 бар (0.2; 0.3; 1.0; 1.8 бар по заявке)

Головки быстрой установки

- Предусмотрены в обширной гамме цветов
- Внутренние прокладки из EPDM или Viton® по заявке



6 UGELLI E PORTAUGELLI

NOZZLES AND NOZZLE HOLDERS / ФОРСУНКИ И ФОРСУНКОДЕРЖАТЕЛИ



Portaugelli con antigoccia a membrana in EPDM/VITON® completi di o-ring di tenuta, vite e dado di fissaggio. Attacco rapido. (testine non incluse)

Nozzle holders with diaphragm check-valve EPDM/VITON®, including o-ring gasket, fixing screw and nut. Quick fitting. (caps not included)

Форсункодержатель с мембранным обратным клапаном из EPDM/ VITON® в комплекте с уплотнительными кольцами, болтом и крепежной гайкой. С фитингом быстрого крепления (головки не включены).

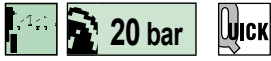

Portaugelli per 2 ugelli.
Double nozzle holders.
Форсункодержатель на 2 форсунки.



EPDM		VITON®						
Part No.	Part No.	Type	F mm	D mm	B mm	bar	Pack	
8244200	8244204	RH	10	20 mm	23,5	20	10	
8244201	8244205		10	25 mm	26,3			
8244202	8244206		10	1/2"	23,5			
8244203	8244207		10	3/4"	26,3			



Portaugelli per 3 ugelli.
Triple nozzle holders.
Форсункодержатель на 3 форсунки.



EPDM		VITON®								
Part No.	Part No.	Type	F mm	D mm	B mm	bar	Pack			
8244208	8244214	RH	7	20 mm	23,5	20	10			
8244220	8244226		10	20 mm	23,5					
8244232	8244238		10	22 mm	23,5					
8244244	8244250		10	25 mm	26,3					
8244256	8244268		7	1/2"	23,5					
8244280	8244292		10	1/2"	23,5					
8244304	8244316		10	3/4"	26,3					
8244328	8244346		10	1"	29,5					
8244209	8244215		LH	7	20 mm			23,5	20	10
8244221	8244227			10	20 mm			23,5		
8244233	8244239	10		22 mm	23,5					
8244245	8244251	10		25 mm	26,3					
8244257	8244269	7		1/2"	23,5					
8244281	8244293	10		1/2"	23,5					
8244305	8244317	10		3/4"	26,3					
8244329	8244347	10		1"	29,5					

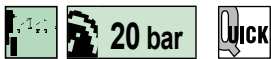

Portaugelli per 4 ugelli.
Quadruple nozzle holders.
Форсункодержатель на 4 форсунки.



EPDM		VITON®								
Part No.	Part No.	Type	F mm	D mm	B mm	bar	Pack			
8244210	8244216	RH	7	20 mm	23,5	20	10			
8244222	8244228		10	20 mm	23,5					
8244234	8244240		10	22 mm	23,5					
8244246	8244252		10	25 mm	26,3					
8244258	8244270		7	1/2"	23,5					
8244282	8244294		10	1/2"	23,5					
8244306	8244318		10	3/4"	26,3					
8244330	8244348		10	1"	29,5					
8244211	8244217		LH	7	20 mm			23,5	20	10
8244223	8244229			10	20 mm			23,5		
8244235	8244241	10		22 mm	23,5					
8244247	8244253	10		25 mm	26,3					
8244259	8244271	7		1/2"	23,5					
8244283	8244295	10		1/2"	23,5					
8244307	8244319	10		3/4"	26,3					
8244331	8244349	10		1"	29,5					

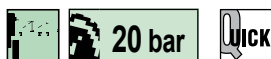

Portaugelli per 5 ugelli.
Quintuple nozzle holders.
Форсункодержатель на 5 форсунок.



EPDM		VITON®					
Part No.	Part No.	Type	F mm	D	B mm	bar	Pack
8244212	8244218		7	20 mm	23,5		
8244224	8244230		10	20 mm	23,5		
8244236	8244242		10	22 mm	23,5		
8244248	8244254	RH	10	25 mm	26,3	20	10
8244260	8244272		7	1/2"	23,5		
8244284	8244296		10	1/2"	23,5		
8244308	8244320		10	3/4"	26,3		
8244332	8244350		10	1"	29,5		
8244213	8244219		7	20 mm	23,5		
8244225	8244231		10	20 mm	23,5		
8244237	8244243		10	22 mm	23,5		
8244249	8244255	LH	10	25 mm	26,3	20	10
8244261	8244273		7	1/2"	23,5		
8244285	8244297		10	1/2"	23,5		
8244309	8244321		10	3/4"	26,3		
8244333	8244351		10	1"	29,5		

TYPE



RH
Versione con antigoccia a destra.
Version with check-valve right.
Вариант с правым обратным клапаном.



LH
Versione con antigoccia a sinistra.
Version with check-valve left.
Вариант с левым обратным клапаном.

OPERATION

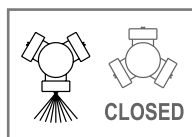

DIMENSIONS

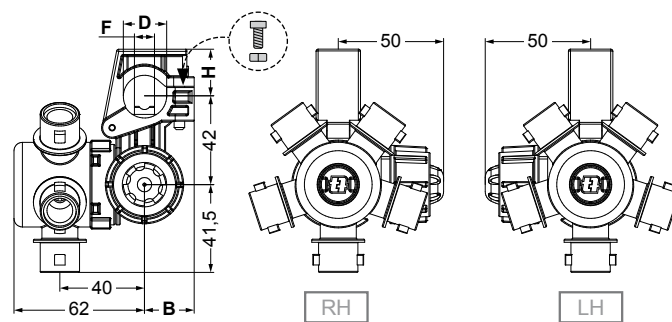

SPARE PARTS

Part No.	Diaphragm Material	Pack	Part No.	F mm	Pack
M0010000	EPDM	50	G00001006	7	50
M0010001	VITON®		G00001008	10	

OPTIONALS



Pag. 254-255

Pag. 262-290

Pag. 245

Portaugelli con antigoccia a membrana in EPDM/VITON® completi di o-ring di tenuta, vite e dado di fissaggio. Attacco rapido. (testine non incluse)

Nozzle holders with diaphragm check-valve EPDM/VITON®, including o-ring gasket, fixing screw and nut. Quick fitting. (caps not included)

Форсункодержатель с мембранным обратным клапаном из EPDM/ VITON® в комплекте с уплотнительными кольцами, болтом и крепежной гайкой. С фитингом быстрого крепления (головки не включены).

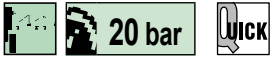

Portaugelli per 3 ugelli.
Triple nozzle holders.
Форсункодержатель на 3 форсунки.



EPDM		VITON®						
Part No.	Part No.	Type	F mm	D	B mm	bar	Pack	
8244262	8244274		7	1/2"	23,5			
8244286	8244298	RH	10	1/2"	23,5	20	10	
8244310	8244322		10	3/4"	26,3			
8244334	8244352		10	1"	29,5			
8244263	8244275	LH	7	1/2"	23,5	20	10	
8244287	8244299		10	1/2"	23,5			
8244311	8244323		10	3/4"	26,3			
8244335	8244353		10	1"	29,5			

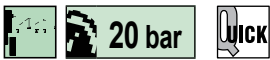

Portaugelli per 4 ugelli.
Quadruple nozzle holders.
Форсункодержатель на 4 форсунки.



EPDM		VITON®						
Part No.	Part No.	Type	F mm	D	B mm	bar	Pack	
8244264	8244276		7	1/2"	23,5			
8244288	8244300	RH	10	1/2"	23,5	20	10	
8244312	8244324		10	3/4"	26,3			
8244336	8244354		10	1"	29,5			
8244265	8244277	LH	7	1/2"	23,5	20	10	
8244289	8244301		10	1/2"	23,5			
8244313	8244325		10	3/4"	26,3			
8244337	8244355		10	1"	29,5			

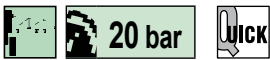

Portaugelli per 5 ugelli.
Quintuple nozzle holders.
Форсункодержатель на 5 форсунки.



EPDM		VITON®						
Part No.	Part No.	Type	F mm	D	B mm	bar	Pack	
8244266	8244278		7	1/2"	23,5			
8244290	8244302	RH	10	1/2"	23,5	20	10	
8244314	8244326		10	3/4"	26,3			
8244338	8244356		10	1"	29,5			
8244267	8244279	LH	7	1/2"	23,5	20	10	
8244291	8244303		10	1/2"	23,5			
8244315	8244327		10	3/4"	26,3			
8244339	8244357		10	1"	29,5			

Dry Boom Fixing



TYPE



Versione con antigoccia a destra.
Version with check-valve right.
Вариант с правым обратным клапаном.



Versione con antigoccia a sinistra.
Вариант с левым обратным клапаном.

OPERATION

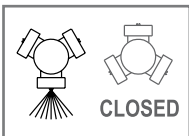

SPARE PARTS

Part No.	Diaphragm Material	Pack
M0010000	EPDM	50
M0010001	VITON®	

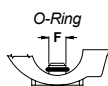

Part No.	F mm	Pack
G00001006	7	50
G00001008	10	

DIMENSIONS

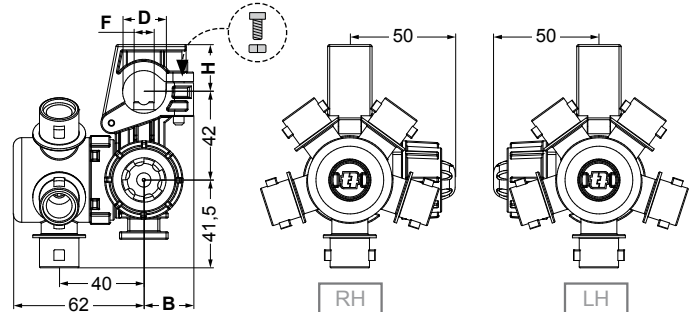

OPTIONALS



Pag. 254-255



Pag. 262-290



Pag. 252



Pag. 245

Portaugelli per 3 ugelli con antigoccia a membrana in EPDM/VITON® completi di O-ring di tenuta. Attacco rapido (testine non include).

Triple nozzle holders with diaphragm check-valve EPDM/VITON® and O-ring gasket. Quick fitting (caps not included).

Форсункодержатель на 3 форсунки с мембранным обратным клапаном из EPDM/VITON®, с уплотнительным кольцом. Фитинг быстрого подключения (без головок).

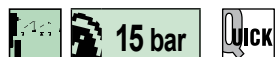

DIMENSIONS

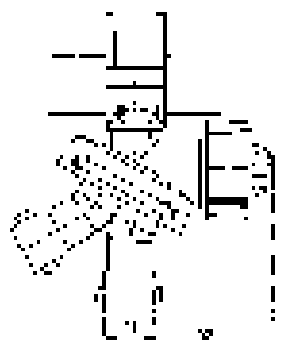

OPERATION

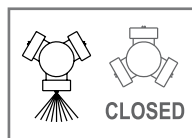

EPDM		VITON®					
Part No.	Part No.	F1	F mm	D	B mm	bar	Pack
8239001	8239011	QUICK	7	1/2"	82	15	10
8239003	8239013		10	1/2"	82		
8239005	8239015		10	3/4"	87		
8239021	8239023		10	1"	87		

SPARE PARTS

Part No.	Diaphragm Material	Pack	Part No.	F mm	Pack
M0010000	EPDM	50	G00001006	7	50
M00100001	VITON®		G00001008	10	

OPTIONALS



Pag. 254



Pag. 262-290



Pag. 245



Part No.	Pack
K00001000	10

Kit vite di fissaggio.
Screw kit.
Комплект крепежного винта.

Portaugelli per 3 ugelli con antigoccia a membrana in EPDM/VITON®. Attacco rapido (testine non include).

Triple nozzle holders with diaphragm check-valve EPDM/VITON®. Quick fitting (caps not included).

Форсункодержатель на 3 форсунки с мембранным обратным клапаном из EPDM/VITON®, с уплотнительным кольцом. Фитинг быстрого подключения (без головок).

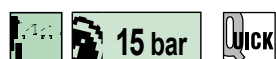

DIMENSIONS

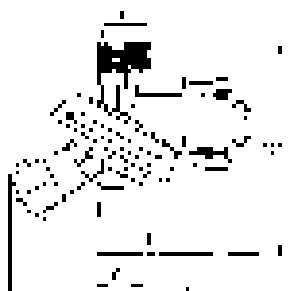
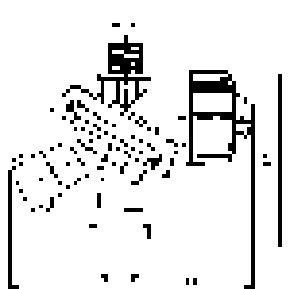

EPDM		VITON®					
Part No.	Part No.	F1	F	bar	Pack		
8239007	8239017	QUICK	1/4 NPT M	15	10		
8239009	8239019		G 3/8 F				

SPARE PARTS

Part No.	Diaphragm Material	Pack
M00100000	EPDM	50
M00100001	VITON®	

OPERATION

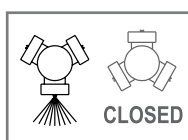

OPTIONALS



Pag. 254-255



Pag. 262-290



Pag. 245

6 UGELLI E PORTAUGELLI

NOZZLES AND NOZZLE HOLDERS / ФОРСУНКИ И ФОРСУНКОДЕРЖАТЕЛИ



Portaugelli con antigoccia a membrana in EPDM/ VITON® con rubinetto di chiusura completi di o-ring di tenuta, vite e dado di fissaggio.

La valvola antigoccia con rubinetto di chiusura permette, ruotando la ghiera rossa posta sull'antigoccia, di chiudere ogni singolo portaugello.

Attacco rapido.

Testine non incluse.

Nozzle holders with diaphragm check-valve in EPDM/ VITON® with stopcock, including o-ring gasket, fixing screw and nut.

The check-valve with stopcock allows each individual nozzle holder to be closed by turning the red ring nut located on the check-valve.

Quick fitting.

Caps not included.

Форсункодержатель с мембранным обратным клапаном из EPDM/ VITON®, снабженный запорным краном, в комплекте, уплотнительными кольцами, болтом и крепежной гайкой. Поворачивая красную зажимную гайку на обратном клапане с запорным краном, можно перекрывать форсункодержатели по одному.

С фитингом быстрого подключения. Головки не включены.

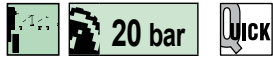

EPDM		VITON®				
Part No.	Part No.	F1	F mm	D	bar	Pack
8234081	8234088		7	20 mm		
8234082	8234089		10	20 mm		
8234083	8234090		7	1/2"		
8234084	8234091	QUICK	10	1/2"	20	25
8234085	-		10	25 mm		
8234086	8234092		10	3/4"		
8234087	8234093		10	1"		



EPDM		VITON®				
Part No.	Part No.	F1	F	bar	Pack	
8234094	8234098		G 1/4 F			
8234095	8234099	G 3/8 M	G 1/4 M	20	25	
8234096	8234100		G 3/8 F			
8234097	8234101		11/16 F			

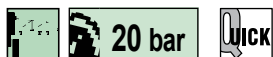

EPDM		VITON®				
Part No.	Part No.	F1	F	bar	Pack	
8234102	8234108		G 1/4 F			
8234103	8234109		1/4 NPT F			
8234104	8234110		G 1/4 M			
8234105	8234111	QUICK	1/4 NPT M	20	25	
8234106	8234112		G 3/8 F			
8234107	8234113		11/16 F			

Valvola antigoccia con rubinetto di chiusura manuale. Permette di chiudere ogni singolo portaugello.

Manual ON-OFF Check Valve.
Enables the user to close each single nozzle individually

Обратный клапан с ручным краном.
Позволяет закрывать каждую отдельную форсунку.



Part No.	bar	Type	Pack
8257002	0,5	EPDM	25
8257003	0,5	VITON®	

OPERATION

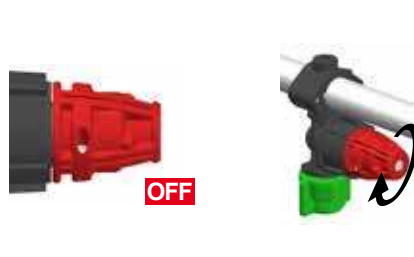
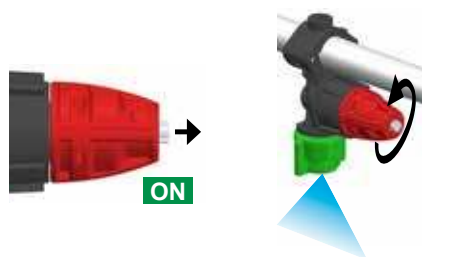

MOUNTING

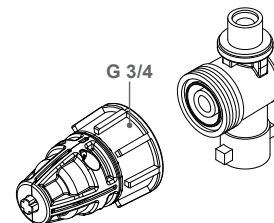

AACV - Valvola antigoccia ad aria
Valvola antigoccia con rubinetto di chiusura pneumatico. Permette di chiudere ogni singolo portaugello.

AACV - Air assisted check valve
Pneumatic ON-OFF Check Valve.
Enables the user to close each single nozzle individually

AACV - обратный клапан пневматический
Обратный мембранный клапан с пневматическим запорным краном. Позволяет закрывать каждый отдельный форсункодержатель.



Part No.	F	F1	Max liquid line bar	Air consumption CF/cycle	Min. opening air pressure bar	Type	Pack
8257005	G 1/4	G 3/4	8	0,015	3,8	EPDM	25
8257008	G 1/8	G 3/4	8	0,015	3,8	EPDM	
8257009	G 1/4	G 3/4	8	0,015	3,8	VITON®	
8257010	G 1/8	G 3/4	8	0,015	3,8	VITON®	

MOUNTING

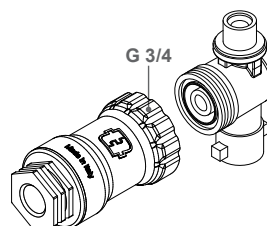

SACV - Valvola antigoccia a solenoide
Valvola antigoccia con rubinetto di chiusura elettrico. Permette di chiudere ogni singolo portaugello.

SACV - Solenoid assisted check valve
Electrical ON-OFF Check Valve.
Enables the user to close each single nozzle individually.

SACV - обратный клапан соленоидный
Обратный клапан с электрическим запорным краном. Позволяет закрывать каждый отдельный форсункодержатель.



Part No.	F	Max liquid line bar	V	Type	Pack
8257007	G 3/4	8	12	VITON®	25

Other voltages and connectors on demand

MOUNTING

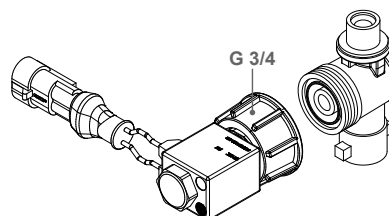

Portaugello con antigoccia a membrana. O-ring di tenuta e testina filettata colore rosso.

Nozzle holders with diaphragm check-valve, sealing O-ring and red coloured threaded cap.

Форсункодержатель с мембранным обратным клапаном, с уплотнительным кольцом и резьбовой головкой красного цвета.



DIMENSIONS

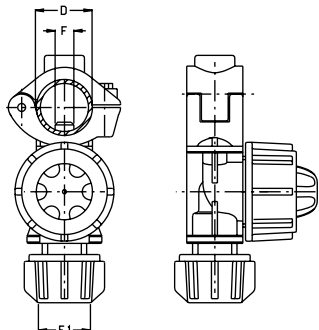

OPERATION

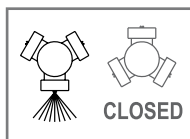

EPDM		VITON®				
Part No.	Part No.	F1	F mm	D	bar	Pack
8234000	8234016		7	20 mm		
8234002	8234018		10	20 mm		
8234004	8234020		7	1/2"		
8234006	8234022	G 3/8 M	10	1/2"	20	25
8234047	8234048		10	25 mm		
8234008	8234024		10	3/4"		
8234050	-		10	1"		

SPARE PARTS

Part No.	Diaphragm Material	Pack
M0010000	EPDM	50
M0010001	VITON®	

Part No.	F mm	Pack
G00001006	7	50
G00001008	10	

OPTIONALS

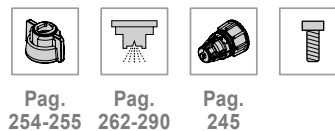

Part No.	Type	Pack
V00007005	PH	25
V00007000	TORX 10x75	

Vite di fissaggio.
Screw.
Крепежный винт.

Portaugello con antigoccia a membrana e O-ring di tenuta.
Attacco rapido (testina non inclusa).

Nozzle holders with diaphragm check-valve and O-ring seal.
Quick fitting (cap not included).

Форсункодержатель с мембранным обратным клапаном и уплотнительным кольцом. Фитинг быстрого подключения (без головок).

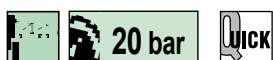

DIMENSIONS

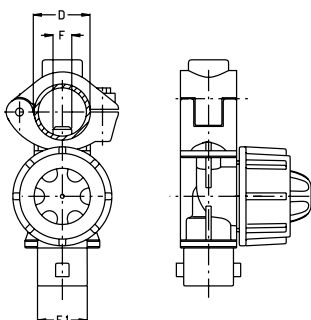

OPERATION

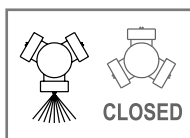

EPDM		VITON®				
Part No.	Part No.	F1	F mm	D	bar	Pack
8234001	8234017		7	20 mm		
8234003	8234019		10	20 mm		
8234005	8234021		7	1/2"		
8234007	8234023	QUICK	10	1/2"	20	25
8234026	8234027		10	25 mm		
8234009	8234025		10	3/4"		
8234051	-		10	1"		

SPARE PARTS

Part No.	Diaphragm Material	Pack
M0010000	EPDM	50
M0010001	VITON®	

Part No.	F mm	Pack
G00001006	7	50
G00001008	10	

OPTIONALS

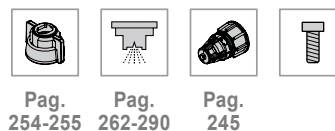

Part No.	Type	Pack
V00007005	PH	25
V00007000	TORX 10x75	

Vite di fissaggio.
Screw.
Крепежный винт.

Portaugello con antigoccia a membrana e testina filettata colore rosso.

Nozzle holders with diaphragm check-valve and red coloured threaded cap.

Форсункодержатель с мембранным обратным клапаном и резьбовым красным колпачком.



DIMENSIONS

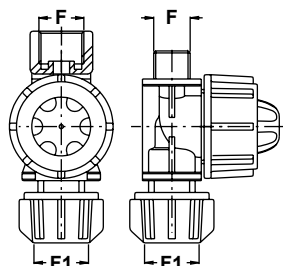

OPTIONALS



Pag. 254-255



Pag. 262-290



Pag. 245

EPDM

VITON®



Part No.	Part No.	F1	F	bar	Pack
8234012	8234028		G 1/4 M		
8234014	8234030	G 3/8 M	G 3/8 F	20	25
8234032	8234036		G 11/16 F		
8234010	8234034		G 1/4 F		

SPARE PARTS



Part No.	Diaphragm Material	Pack
M00100000	EPDM	50
M00100001	VITON®	

Portaugello con antigoccia a membrana. Attacco rapido (testina non inclusa).

Nozzle holders with diaphragm check-valve. Quick fitting (cap not included).

Форсункодержатель с мембранным обратным клапаном. Фитинг быстрого подключения (без головок).

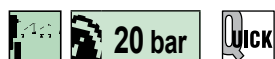

DIMENSIONS

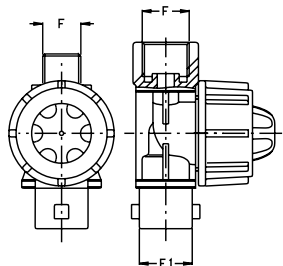

OPTIONALS



Pag. 254-255



Pag. 262-290



Pag. 245

EPDM

VITON®



Part No.	Part No.	F1	F	bar	Pack
8234013	8234029		G 1/4 M		
8234011	8234043		1/4 NPT M		
8234015	8234031	QUICK	G 3/8 F	20	25
8234035	8234041		11/16 F		
8234037	8234045		1/4 NPT F		
8234033	8234039		G 1/4 F		

SPARE PARTS



Part No.	Diaphragm Material	Pack
M00100000	EPDM	50
M00100001	VITON®	

Portaugello con antigoccia a membrana.

Nozzle holders with diaphragm check-valve

Форсункодержатель с мембранным обратным клапаном.



DIMENSIONS

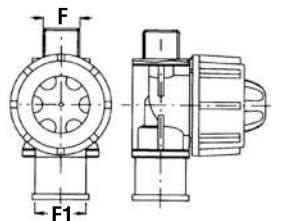

OPTIONALS



Pag. 254-255



Pag. 262-290



Pag. 245

EPDM

VITON®



Part No.	Part No.	F1	F mm	bar	Pack
8234040	8234044	1/4 NPT F	1/4 NPT M	20	25

SPARE PARTS



Part No.	Diaphragm Material	Pack
M00100000	EPDM	50
M00100001	VITON®	

Portaugello completo di O-ring di tenuta e testina filettata colore rosso.

Nozzle holder with O-ring seal and red coloured threaded cap.

Форсункодержатель с кольцевым уплотнением и резьбовым красным колпачком.



DIMENSIONS

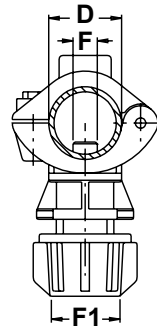

Part No.	F1	F mm	D	bar	Pack
8230000		7	20 mm		
8230002		10	20 mm		
8230004	G 3/8 M	7	1/2"	20	25
8230006		10	1/2"		
8230008		10	3/4"		
8230010		10	1"		

SPARE PARTS

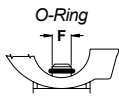

Part No.	F mm	Pack
G00001006	7	50
G00001008	10	

OPTIONALS



Pag. 254-255



Pag. 262-290



Part No.	Type	Pack
V00007005	PH	25
V00007000	TORX 10x75	

Vite di fissaggio.
Screw.
Крепежный винт.

Portaugello completo di O-ring di tenuta. Attacco rapido (testina non inclusa).

Nozzle holder with O-ring seal. Quick fitting (cap not included).

Форсункодержатель с кольцевым уплотнением. Фитинг быстрого подключения (без головок).

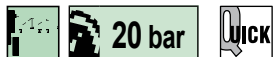

DIMENSIONS

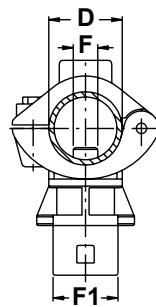

Part No.	F1	F mm	D	bar	Pack
8230001		7	20 mm		
8230003		10	20 mm		
8230005	QUICK	7	1/2"	20	25
8230007		10	1/2"		
8230009		10	3/4"		
8230011		10	1"		

SPARE PARTS

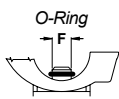

Part No.	F mm	Pack
G00001006	7	50
G00001008	10	

OPTIONALS



Pag. 254-255



Pag. 262-290



Part No.	Type	Pack
V00007005	PH	25
V00007000	TORX 10x75	

Vite di fissaggio.
Screw.
Крепежный винт.

Portaugello completo di O-ring di tenuta e testina filettata colore rosso.

Nozzle holder with O-ring seal and red coloured threaded cap.

Форсункодержатель с уплотнительным кольцом и резьбовым красным колпачком.



DIMENSIONS

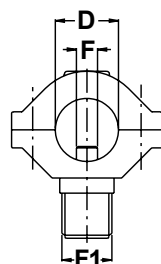

Part No.	F1	F mm	D	bar	Pack
8230012	G 3/8 M	7	1/2"	20	25

SPARE PARTS

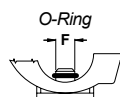

Part No.	F mm	Pack
G00001006	7	50

OPTIONALS



Pag. 254-255



Pag. 262-290



Part No.	Pack
K00001000	10

Kit vite di fissaggio.
Screw kit.
Комплект крепежного винта.

Portaugello completo di O-ring di tenuta. Attacco rapido (testina non inclusa).

Nozzle holder with O-ring seal. Quick fitting (cap not included).

Форсункодержатель с уплотнительным кольцом. Фитинг быстрого подключения (без головки).

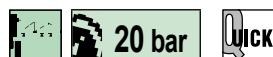

DIMENSIONS

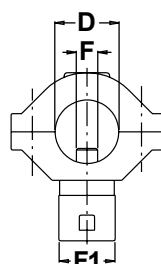

Part No.	F1	F mm	D mm	bar	Pack
8230013	QUICK	7	1/2"	20	25

SPARE PARTS

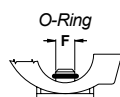

Part No.	F mm	Pack
G00001006	7	50

OPTIONALS



Pag. 254-255



Pag. 262-290



Part No.	Pack
K00001000	10

Kit vite di fissaggio.
Screw kit.
Комплект крепежного винта.

Morsetto con battuta piana

Flat seat clamp

Зажим с плоской посадочной поверхностью



DIMENSIONS

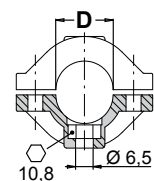

Part No.	D	Pack
8294013	1/2"	
8294027	3/4"	25
8294026	1"	

OPTIONALS



Part No.	Pack
K00001000	10

Kit vite di fissaggio.
Screw kit.
Комплект крепежного винта.

Portaugelli regolabili per barre diserbo.
Completi di testina filettata colore rosso.

Nozzle holders for dry booms.
Complete with red coloured threaded cap.

Регулируемые форсункодержатели для штанг опрыскивателей. С резьбовым красным колпачком.



Part No.	Ø mm	Pack
8231000	10 (3/8")	
8231002	13 (1/2")	25
8231004	19 (3/4")	

Part No.	Ø mm	Pack
8231006	10 (3/8")	
8231008	13 (1/2")	25
8231010	19 (3/4")	

Part No.	Ø mm	Pack
8231012	10 (3/8")	
8231014	13 (1/2")	25
8231016	19 (3/4")	

Dry Boom Fixing



OPTIONALS



Pag. 254-255

Pag. 262-290

Pag. 252

Portaugelli regolabili per barre diserbo.
Attacco rapido (testina non inclusa).

Nozzle holders for dry booms.
Quick fitting (cap not included).

Регулируемые форсункодержатели для штанг опрыскивателей. Фитинг быстрого подключения (без головки).

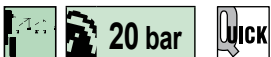

Part No.	Ø mm	Pack
8231001	10 (3/8")	
8231003	13 (1/2")	25
8231005	19 (3/4")	

Part No.	Ø mm	Pack
8231007	10 (3/8")	
8231009	13 (1/2")	25
8231011	19 (3/4")	

Part No.	Ø mm	Pack
8231013	10 (3/8")	
8231015	13 (1/2")	25
8231017	19 (3/4")	

Dry Boom Fixing



OPTIONALS



Pag. 254-255

Pag. 262-290

Pag. 252

Portaugelli regolabili per barre diserbo, con antigoccia a membrana (EPDM). Attacco rapido (testina non inclusa).

Nozzle holders for dry booms, with diaphragm check-valve (EPDM). Quick fitting (cap not included).

Регулируемые форсункодержатели для штанг опрыскивателей, с мембранным обратным клапаном (EPDM). Фитинг быстрого подключения (без головки).

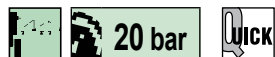

Part No.	Ø mm	Pack
8235001	10 (3/8")	
8235003	13 (1/2")	25
8235005	19 (3/4")	

Part No.	Ø mm	Pack
8235007	10 (3/8")	
8235009	13 (1/2")	25
8235011	19 (3/4")	

Part No.	Ø mm	Pack
8235013	10 (3/8")	
8235015	13 (1/2")	25
8235017	19 (3/4")	

Part No.	Ø mm	Pack
8235019	10 (3/8")	
8235021	13 (1/2")	25
8235023	19 (3/4")	

Part No.	Ø mm	Pack
8235025	10 (3/8")	
8235027	13 (1/2")	25
8235029	19 (3/4")	

Dry Boom Fixing



SPARE PARTS

Part No.	Diaphragm Material	Pack
M00100000	EPDM	50
M00100001	VITON®	

OPTIONALS



Pag. 254-255



Pag. 262-290



Pag. 252



Pag. 245

Portaugello regolabile per 3 ugelli con antigoccia a membrana (EPDM) per barre da diserbo. Attacco rapido (testine non incluse).

Adjustable triple nozzle holders with diaphragm (EPDM) check-valve for dry booms. Quick fitting (caps not included).

Регулируемые форсункодержатели на 3 форсунки, с мембранным обратным клапаном (EPDM) для штанг опрыскивателей (фитинг быстрого подключения (без головок)).

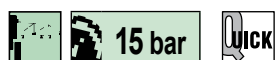

Part No.	Ø mm	Pack
8240001	13 (1/2")	25
8240003	19 (3/4")	

Part No.	Ø mm	Pack
8240005	13 (1/2")	25
8240007	19 (3/4")	

Part No.	Ø mm	Pack
8240009	13 (1/2")	25
8240011	19 (3/4")	

Dry Boom Fixing



SPARE PARTS

Part No.	Diaphragm Material	Pack
M00100000	EPDM	50
M00100001	VITON®	

OPTIONALS



Pag. 254-255



Pag. 262-290



Pag. 252



Pag. 245

Portaugelli registrabili con antigoccia a membrana (EPDM) per barre diserbo 13 mm.
Attacco rapido (testine non incluse).

Nozzle holders with diaphragm (EPDM) check-valve for dry booms 13 mm.
Quick fitting (caps not included).

Регулируемые форсункодержатели, с мембранным обратным клапаном (EPDM) для штанг опрыскивателей 13 мм. Фитинг быстрого подключения (без головок).

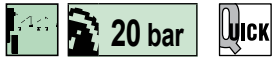

SINGLE LEFT



DOUBLE



SINGLE RIGHT

Part No.	Ø mm	Pack
8235035	13 (1/2")	25

Part No.	Ø mm	Pack
8235033	13 (1/2")	25

Part No.	Ø mm	Pack
8235031	13 (1/2")	25

SPARE PARTS

Part No.	Diaphragm Material	Pack
M00100000	EPDM	50
M00100001	VITON®	

OPTIONALS



Pag. 254-255



Pag. 262-290



Pag. 252



Pag. 245

Supporto portagomma registrabile con attacco filettato 1/4" NPT per barre diserbo.

Adjustable hosetail with threaded fitting 1/4" NPT for dry booms.

Регулируемый суппорт штуцера с резьбовым фитингом 1/4" F NPT для штанг опрыскивателей.



Part No.	Ø mm	Pack
8231018	10 (3/8")	
8231020	13 (1/2")	25
8231022	19 (3/4")	

Part No.	Ø mm	Pack
8231024	10 (3/8")	
8231026	13 (1/2")	25
8231028	19 (3/4")	

Part No.	Ø mm	Pack
8231030	10 (3/8")	
8231032	13 (1/2")	25
8231034	19 (3/4")	

Dry Boom Fixing



OPTIONALS



Pag. 252



CLAMPS

Fascette di montaggio per portaugelli regolabili.

Mounting clamps for nozzle holders.

Монтажные зажимы для регулируемых форсункодержателей.



Part No.	Ø mm	Pack
8235036	26,4 (3/4")	
8235038	33,3 (1")	25
8235040	42 (1"1/4")	



Part No.	Ø mm	Pack
8235037	19 (3/4")	
8235039	25 (1")	25
8235041	31,8 (1"1/4")	
8235043	38 (1"1/2")	

Derivazione a 45° con attacco rapido.

45° Quick coupling.

Соединение 45°, с фитингом быстрого подключения.



Part No.	F	Pack
8230018	QUICK	25



Attacco rapido per testina a 90°.

90° Quick coupling for cap.

Фитинг быстрого подключения для головки 90°.



Part No.	F	Pack
8230022	QUICK	25



Terminale barra filetto - attacco rapido a 45°.

Threaded spraying boom terminal – quick coupling elbow (45°).

Резьбовой терминал штанги – фитинг быстрого подключения 45°.



Part No.	F	Pack
8230016	G 1/2"	25
8230014	G 3/4"	25



Adattatori attacco rapido

Quick-fitting adapters

Адаптеры быстрого подключения



Part No.	F	Pack
8230015	G 1/4" BSP	25
8230017	1/4" NPT	



Part No.	F	Pack
8230019	G 1/4" BSP	25
8230021	1/4" NPT	

Manicotto attacco rapido per lavaggio barra

Boom flushing quick-fitting adapter

Муфта быстрого подключения для мойки штанги



Part No.	Pack
8253040	25

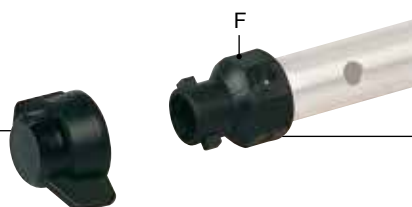

Part No.	F	Pack
8294020	G 3/8" BSP	25
8294021	G 1/2" BSP	
8294022	G 3/4" BSP	

Raccordo portagomma per portaugelli regolabili

Hose fitting for adjustable nozzle holders

Соединение штуцера для регулируемых форсункодержателей



DIMENSIONS

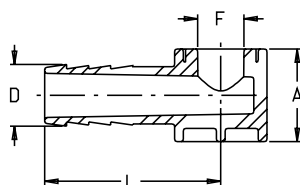

Part No.	A	D mm	F mm	L mm	Pack
8294014	1/2"	13	10,5	40	25
8294015	3/4"	20	10,5	40	
8294016	3/4"	26	10,5	40	
8294023	1/2"	13	7,5	40	
8294028	1"	19	10,5	40	
8294029	1"	25	10,5	40	





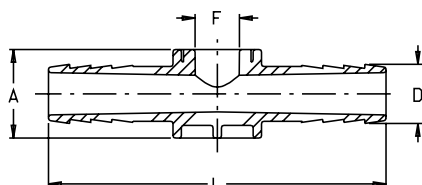





DIMENSIONS











Part No.	A	D mm	F mm	L mm	Pack
8294017	1/2"	13	10,5	80	25
8294018	3/4"	20	10,5	80	
8294019	3/4"	26	10,5	80	
8294024	1/2"	13	7,5	80	
8294030	1"	19	10,5	80	
8294031	1"	25	10,5	80	



QUICK CAPS

	P/N	Colour	P/N	Colour	Pack	Suitable for	Spare parts
	8253000	red	8253042	orange	25	GEOLINE®: BD, ADGA, RS, EZK, EZK-TWIN, AD, PB, AZ, KR5 ASJ®: SF, SFA, WR, WRC, LD, LDC, EF, TLT, AFC, CFA, CFA-U, OC Albuz®: API, ADI, AXI80, AXI110, OCI, CVI110 Lechler®: IDK, IDKN, IDKT, LU, AD, AD90, ST, IDKS, ES, OC(small size)	G00002020
	8253001	yellow	8253043	brown			
	8253002	green	8253048	black			
	8253003	blue	8253118	grey			
	8253041	white	8253119	violet			
	8253004	red	8253046	white	25	ASJ®: TFS, TFLD, PSP, BX, TFA Albuz®: APE, EXA, ESI, AVI110, AVIOC, MVI, AVI80, AVI-TWIN	G00002020
	8253005	yellow	8253044	orange			
	8253006	green	8253045	brown			
	8253007	blue	8253055	black			
	8253008	red	8253057	brown	25	GEOLINE®: EZ Lechler®: serie 652, serie ID	G00002020
	8253009	yellow	8253049	black			
	8253010	green	8253120	grey			
	8253011	blue	8253121	light blue			
	8253056	orange					
	8253012	red	8253059	brown	25	ASJ®: DEF, HC Albuz®: APM TeeJet®: TK FloodJet®, FL FullJet®, TG FullCone, TX, AITXA, ConeJet® Lechler®: TR, ITR	G00002020
	8253013	yellow	8253050	black			
	8253014	green	8253122	light green			
	8253015	blue	8253123	white			
	8253058	orange	8253124	grey			
	8253016	red	8253060	orange	25	DISC AND CORE - AITXA	/
	8253017	yellow	8253061	brown			
	8253018	green	8253062	black			
	8253019	blue					
	8253020	red	8253063	orange	25	ASJ®: HCC, HCI80, HCI60, HCI40, NC DC Albuz®: ATR 80, ATR 60, ATI 60, TVI80, ATR, AMPT	G00002020 + G00001060
	8253021	yellow	8253064	brown			
	8253022	green	8253065	black			
	8253023	blue					
	8253024	red	8253066	orange	25	TeeJet® Flat Spray tips (larger capacities) Standard: -10 -20 XR -10 -15	G00002020 + G00001060
	8253025	yellow	8253067	brown			
	8253026	green	8253068	black			
	8253027	blue	8253125	white			
	8253028	red	8253070	brown	25	GEOLINE®: AD/D, AD-IA, ST-IA, ST, TM-IA, PB-IA, AS-IA, AD/IA-D, AD/T TJ TwinJet®: No. TJ60 Spray Tip TeeJet®: TTI, SJ3, DGTJ60, AI, AIUB, No. AI spray Nozzle	G00002020
	8253029	yellow	8253071	black			
	8253030	green	8253126	white			
	8253031	blue	8253127	light blue			
	8253069	orange	8253128	violet			
	8253032	red	8253072	orange	25	ASJ®: DEF140, TK-VS FloodJet®, Turbo FloodJet™	G00002020
	8253033	yellow	8253073	brown			
	8253034	green	8253051	black			
	8253035	blue	8253129	white			

	P/N	Colour	P/N	Colour	Pack	Suitable for	Spare parts	
	8253036	red	8253074	orange	25	Hardi: flat fan nozzles	G00002020	
	8253037	yellow	8253075	brown				
	8253038	green	8253052	black				
	8253039	blue						
	8253086	red	8253090	orange	25	GEOLINE®: MAG, MAG-CH	G00002020	
	8253087	yellow	8253091	brown				
	8253088	green	8253092	black				
	8253089	blue						
	8253093	red	8253097	orange	25	GEOLINE®: MGA	G00002020	
	8253094	yellow	8253098	grey				
	8253095	green	8253099	black				
	8253096	violet						
	8253100	red	8253104	orange	25	GEOLINE®: CV-IA	G00002020	
	8253101	yellow	8253105	violet				
	8253102	green	8253106	black				
	8253103	blue					GEOLINE®: MCP*	*G00002020 + G00001060
	8253107	red			25	GEOLINE®: X	G00002020	
	8253108	blue						
	8253109	white						
	8253110	orange						
	8253111	red	8253116	brown	25	GEOLINE®: TKP	G00002020	
	8253113	green	8253117	black				
	8253114	blue	8253112	yellow				
	8253115	orange						
	8253040	black			25	CLOSED: PROVIDES SHUTOFF NOZZLE FOR QUICK SPACING CHANGE	G00002020	
	8253047	black			25	THREADED CAP 1/4" NPT	G00002020	
	8253130	black				THREADED CAP 1/8" NPT		



THREADED CAPS

Part No.	Colour	Type	Pack
8040102	red		25
8040103	yellow		
8040104	green		
8040105	blue		

Girelli G 3/8 serraugelli.
 3/8 BSP nozzle fitting fly nuts.
 Барашковые гайки G 3/8 для форсунок.

6 UGELLI E PORTAUGELLI

NOZZLES AND NOZZLE HOLDERS / ФОРСУНКИ И ФОРСУНКОДЕРЖАТЕЛИ



Kit testina attacco rapido universale.

- Consente di poter alloggiare tutti i tipi di ugello con Ø8 e Ø10 mm.
- Completa di guarnizione.

Kit for head with universal quick-release coupling.
- Used to fit all types of nozzle with Ø8 and Ø10 mm.
- Complete with gasket.

Комплект головки с универсальным фитингом быстрого подключения.
- Позволяет установить все форсунки Ø8 и Ø10 мм.
- В комплектации с прокладкой.

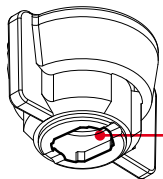
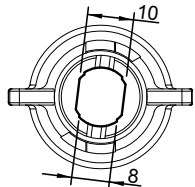

Part No.	color	For nozzles	Type	
			Ø8mm	Ø10mm
8253085	grey			
8253084	violet			
8253083	brown			
8253082	orange	Lechler®, Albus®, TeeJet®, Geoline®, Lurmark®, Tecnomat®		TR, ITR
8253081	white	Arag®, John Deere®	IDK, IDKN, IDKT, IDKS,	TK FloodJet®
8253080	black	Hypro®, Vicon®, Douven®, Dubex®, CHD Eefting®, Rau® (from 2000), Inuma®, Dammann®, Jacoby®	AD, LU, ST, ES, OC, ADI, API, APS, ADX	TXA ConeJet®, FL FullJet®, TG Fullcone®
8253079	blue			AI TeeJet®
8253078	green			TKFloodjet®
8253077	yellow			VS Floodjet®
8253076	red			
8253131	lilac			

Sede ugello con doppio centraggio
Nozzle seat with double centring
Гнездо форсунки с двойным центрированием

Espositori ugelli Geoline

- completi di ganci;
- materiale: cartone automontante.

Geoline nozzles exhibitors

- complete with hooks;
- material: cardboard.

Стойки для форсунок Geoline

- в комплекте с крючками;
- материал: самосборный картон.

Disponibile in due versioni: da banco e appeso

Available in two versions: desk and wall versions.

Доступны в двух вариантах: настольный и настенный

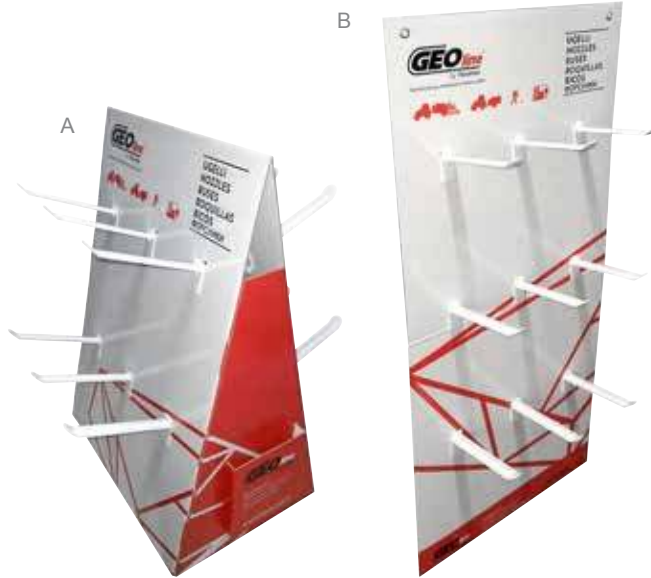

	Part No.	Number of hooks	Number of blister	Pack
A	K99904000	12	60	1
B	K99904001	9	45	1

Vaso misuratore

Measuring jug

Измерительная емкость



Part No.	l	Pack
8257000	2	3

UGELLI

■ Geoline è lieta di presentare la nuova gamma di ugelli per il trattamento alle colture denominata Geoline Tips, realizzata sia in ceramica che in resina acetale, in collaborazione con una importante storica azienda Brasiliana.

■ La gamma realizzata da Geoline copre le più disparate necessità nei trattamenti agricoli offrendo una elevata qualità durata e affidabilità frutto della conoscenza specifica del settore.

■ La nostra gamma di ugelli è prodotta nei colori e nelle portate indicati dalla normativa ISO 10625.

■ Gli ugelli vengono prodotti con diversi materiali adatti alle svariate esigenze utilizzando le migliori resine acetali che, Delrin®, e utilizziamo la ceramica Allumina al 99% di purezza

NOZZLES

■ Geoline is pleased to present its new range of nozzles for treating crops, Geoline Tips, made both in ceramic and acetal resin in collaboration with an important long-standing Brazilian company.

■ Geoline's range covers the most diversified needs in agricultural treatment, offering high quality, long life and reliability thanks to its specific know how in this sector.

■ Our range of nozzles is produced in the colours and with the flow rates indicated in the ISO 10625 standard.

■ The nozzles are made with materials suited to many different requirements, using the best acetal resins, Delrin® and 99% pure alumina ceramic.

ФОРСУНКИ

■ Geoline представляет новую серию форсунок для обработки культур Geoline Tips, изготовленную как из керамики, так и из ацетальной смолы, в сотрудничестве с крупной бразильской компанией.

■ Гамма продукции, изготовленная Geoline, отвечает самым различным требованиям сельскохозяйственной обработки, обеспечивая высокое качество, долговечность и надежность, что является результатом превосходного знания данной области.

■ Наша гамма форсунок произведена в цветах и с расходами, указанными в стандарте ISO 10625.

■ Форсунки изготовлены из различных материалов, пригодных для самых различных сфер применения, при использовании лучших ацетальных смол, Delrin® и керамики Алюмина на 99%.

VMD Classi di grandezza delle gocce / Drop size classes / Классы величины капли

MF	F	M	G	MG	EG
MOLTO FINE VERY SMALL ОЧЕНЬ МАЛАЯ	FINE SMALL МАЛАЯ	MEDIA MEDIUM СРЕДНЯЯ	GROSSA BIG БОЛЬШАЯ	MOLTO GROSSA VERY BIG ОЧЕНЬ БОЛЬШАЯ	ESTREM. GROSSA EXTREMELY BIG МАКС.БОЛЬШАЯ
< 150 Microns	150 ÷ 250 Microns	250 ÷ 350 Microns	350 ÷ 450 Microns	450 ÷ 550 Microns	> 550 Microns

TABELLA APPLICATIVA

Secondo i test eseguiti dal Dr. Matthew Novak ed altri ricercatori dell'Università dell'Oregon, negli Stati Uniti, la durata di un ugello in ceramica può superare le 1000 ore di lavoro, a seconda dei fattori indicati di seguito:

* **Pressione:** Maggiore è la pressione, tanto più rapido sarà il processo di usura.

* **Tipo di prodotto:** Quanto più è abrasivo, maggiore sarà il grado di usura.

* **Qualità dell'acqua:** Quante più impurità saranno presenti, tanto più rapido sarà il processo di usura.

* **Pulizia:** Non utilizzare mai oggetti metallici o appuntiti. In caso di intasamenti, usare getti d'aria, acqua pulita o una spazzola con setole di nylon per non danneggiare gli ugelli.

APPLICATION TABLE

According to the tests conducted by Mr. Matthew Novak and other researchers of the Oregon University in the United States, the life of a ceramic nozzle can exceed 1,000 hours of use, depending on the following factors:

* **Pressure:** The nozzle will wear quicker with a higher pressure.

* **Type of product:** The nozzle will wear quicker the more abrasive the product is.

* **Quality of the water:** The more impurities there are in the water the quicker the nozzle will wear.

* **Cleaning:** Never use metal or pointed objects. In the case of clogging, use jets of air, clean water or a nylon bristle brush so as not to damage the nozzles.

ТАБЛИЦА ПРИМЕНЕНИЯ































На основе результатов испытаний, проведенных Мэтью Новак и других исследователей университета Орегона США, срок службы керамической форсунки может превышать 1000 часов, в зависимости от указанных далее факторов:

* **Давление :** чем больше давление, тем быстрее будет процесс изнашивания.



































* **Тип продукта :** большие абразивные характеристики обуславливают большую степень изнашивания.

* **Качество воды:** большее количество загрязнений в воде обуславливает более быстрый процесс изнашивания.

* **Очистка :** никогда не использовать металлические или острые предметы. В случае засорений, следует использовать струи воздуха, чистую воду или щетку с нейлоновой щетиной для предупреждения повреждения форсунок

Choose your nozzle	LOW CROPS										
	CERAMIC FLAT NOZZLES										
TYPE OF NOZZLES	BD LOWRED DRIFT FLAT SPRAY	AS-IA TWIN AIR INDUCTION FLAT SPRAY	AD DRIFT REDUCTION FLAT SPRAY	ADGA WIDE ANGLE DRIFT REDUCTION FLAT SPRAY	AD-IA ANTI DRIFT AIR INDUCTION FLAT SPRAY	AD-IA/D TWIN AIR INDUCTION FLAT SPRAY	AD/D TWIN FLAT SPRAY	AD/T TRIPLE FLAT SPRAY	ST-IA AIR INDUCTION SUPER TURBO FLAT SPRAY	ST SUPER TURBO FLAT SPRAY	
											
SPRAY PATTERNATION											
DROPLETS SIZE CHARACTERISTICS											
DRIFT HAZARDS	Medium	Very Low	Medium	Medium	Very Low	Very Low	Medium	Medium	Very Low	Low	
RECOMMENDED PRESSURES	1 - 4 bar	2 - 7,6 bar	2 - 4 bar	2 - 4 bar	2 - 7.5 bar	2 - 7.5 bar	2 - 4 bar	2,8 - 9 bar	2 - 6,5 bar	1,5 - 6 bar	
HERBICIDES	Incorporated treatment	Excellent	Excellent	Excellent	Excellent	Excellent	Excellent	Excellent	Excellent	Excellent	
	Pre emergent	Excellent	Excellent	Excellent	Excellent	Excellent	Excellent	Excellent	Excellent	Excellent	
	Post emergent	Contact	Good	Good*	Good	Good	Good*	Good*	Excellent	Excellent	Good*
		Systemic	Excellent	Excellent	Excellent	Excellent	Excellent	Excellent	Excellent	Excellent	Excellent
FUNGICIDES	Contact	Good	Good*	Good	Good		Good*	Excellent	Excellent	Good*	
	Systemic	Excellent	Excellent	Excellent	Excellent	Good*	Excellent	Excellent	Excellent	Excellent	
INSECTICIDES	Contact	Good	Good*	Good	Good		Good*	Excellent	Excellent	Good*	
	Systemic	Excellent	Excellent	Excellent	Excellent	Good*	Excellent	Excellent	Excellent	Excellent	

 * for a low pressure

		ORCHARD-VINEYARD: FULL CONE, HOLLOW CONE & FLAT NOZZLES					OTHERS APPLICATIONS						
	PLASTIC	CERAMIC					CERAMIC					PLASTIC	
	AZ	MAG	MGA	MAG-CH	CV-IA	X	TM-IA	PB	PB-IA	MX	DEFLECTOR (TKP)	MCP	
	LOWERED DRIFT POLYACETAL FLAT SPRAY	HOLLOW CONE CERAMIC	HOLLOW CONE ATOMIZED DROPLETS	FULL CONE CERAMIC 80°	AIR INDUCTION HOLLOW CONE	FOGGING HOLLOW CONE	DEFLECTOR TURBO	OFF-CENTER FLAT SPRAY	AIR INDUCTION OFF-CENTER FLAT SPRAY	JET BOOMLESS FLAT	DEFLECTOR POLYACETAL	HOLLOW CONE POLYACETAL	
													
													
													
	Medium	High	High	High	Medium	High	Very Low	Medium	Very Low	Low	Medium	High	
	3 - 4 bar	4 - 20 bar	4,5 - 20 bar	3,5 - 10 bar	3 - 10 bar	5,5 - 13,8 bar	2 - 6 bar	2 - 4 bar	2 - 7,5 bar	2 - 5 bar	1 - 3 bar	2 - 6 bar	
	Excellent						Excellent	Excellent	Excellent	Excellent	Excellent		
	Excellent						Excellent	Excellent	Excellent	Excellent	Excellent		
	Good*							Good			Good		
	Excellent						Excellent	Excellent	Excellent	Excellent	Excellent		
	Good*	Excellent	Excellent	Excellent	Good	Excellent		Good			Good	Excellent	
	Excellent	Excellent	Excellent	Excellent	Excellent	Excellent		Excellent	Good	Good	Good	Excellent	
	Good*	Excellent	Excellent	Excellent	Good	Excellent		Good			Good	Excellent	
	Excellent	Excellent	Excellent	Excellent	Excellent	Excellent		Excellent	Good	Good	Good	Excellent	

Dati importanti sulla tecnologia di atomizzazione

Atomizzazione

Il processo di atomizzazione scompone i liquidi in goccioline. La maggior parte degli ugelli usati in agricoltura sfrutta l'atomizzazione idraulica ottenuta dalla con l'effetto legato alla conformazione della bocca della testina dell'ugello. Questi due fattori aumentano la velocità di efflusso del liquido da atomizzare, convertendo l'energia potenziale in energia cinetica (= velocità). Per effetto dello scarico di tensione subito dal liquido quando esce dall'ugello, si produce una lamella di liquido inizialmente piatta, che man mano diviene ondulata perdendo la sua stabilità. Si creano così strisce di liquido che si disintegrano in goccioline di varie dimensioni.

Specifiche tecniche

I dati prestazionali degli ugelli per agricoltura Geoline sono riportati secondo le indicazioni previste dagli standard internazionali e includono le seguenti informazioni:

- tipo di ugello
- angolo di spruzzo
- dimensioni della testina

Gli ugelli Geoline sono provvisti di codici colore ISO: a ogni colore corrisponde una portata specifica.

Copertura

La copertura teorica di un dato ugello è determinata fondamentalmente dall'angolo e dall'altezza di spruzzo, vale a dire, dalla distanza tra l'ugello e la superficie target da trattare.

In base all'altezza dell'ugello e alle sue dimensioni, l'angolo di spruzzo e l'accuratezza di distribuzione possono dipendere in certa misura dalla pressione di spruzzo. La pressione di spruzzo consigliata sulla testina dell'ugello e l'altezza di spruzzo minima per una distanza specifica tra gli ugelli, sono quindi due requisiti che consentono di ottenere una distribuzione uniforme di liquido secondo la configurazione dello spruzzo prevista.

Si applicano in linea generale le seguenti leggi fisiche di regolarità (i dati nella tabella sono relativi all'acqua):

- Liquidi di spruzzo con viscosità superiori a quella dell'acqua hanno angoli di spruzzo più ridotti.
- Liquidi di spruzzo con minore tensione superficiale di quella dell'acqua hanno angoli di spruzzo più ampi.
- La densità del liquido di spruzzo ha un effetto limitato sull'angolo di spruzzo.

A seguito dell'effetto di caduta del getto di spruzzo, che dal punto di vista fisico è inevitabile, la copertura effettiva può risultare inferiore rispetto alla copertura teorica indicata nella tabella, soprattutto in casi legati a pressione di spruzzo bassa e altezza di spruzzo consistente.

Due to the physically unavoidable effect of spray-jet droop, the effective coverage may fall short of the theoretical coverage listed in the above table, especially in cases involving low spray pressure and substantial spray height.

Под эффектом падения струи, что с физической точки зрения является неизбежным явлением, эффективное покрытие может быть меньшим по сравнению с теоретическим покрытием, указанным в таблице, в большей степени, в случаях, связанных с низким давлением распыления и значительной высотой распыления.

Principal Facts of Spray Nozzle Technology

Atomization

The atomization process breaks liquids down into droplets. Most of the nozzles used in agriculture rely on hydraulic atomization resulting from fluid pressure in combination with the orifice effect of the nozzle tip. Those two factors accelerate the flow velocity of the medium to be atomized. This converts potential energy into kinetic energy (= speed). The release of tension experienced by the liquid as it emerges from the nozzle tip produces an initially flat lamella of liquid that soon loses its stability and becomes wavy. That gives rise to strings of liquid that disintegrate into droplets of various size.

Specification

The performance data of Geoline agricultural spray nozzles are stated in accordance with international standards and include the following information:

- type of nozzle
- spray angle
- tip size

Geoline nozzles are ISO color-coded, with each different color corresponding to a defined flow rate.

Coverage

The theoretical coverage of a given nozzle is chiefly determined by the spray angle and the spray height, i.e., the distance between the nozzle and the target surface. Depending on the height of the nozzle and its size, the spray angle and accuracy of distribution can depend to a certain extent on the spray pressure. Hence, the recommended spray pressure at the nozzle tip and the minimum spray height for a specific nozzle spacing are two prerequisites for the uniform distribution of liquid within the spray pattern.

The following laws of physical regularity apply in principle

(data in table based on water):

- Spray media with viscosities higher than that of water have narrower spray angles.
- Spray media with less surface tension than that of water have broader spray angles.
- The density of the spray medium has little effect on the spray angle.

Важные данные в отношении технологии распыления

Распыление

Процесс распыления обеспечивает разделение жидкостей в капли. Большая часть форсунок, используемых в сельском хозяйстве, использует гидравлическое распыление, достигаемое на основе эффекта, связанного с образованием отверстия на головке форсунки. Эти два фактора увеличивают скорость обратного потока распыляемой жидкости, преобразуя потенциальную энергию в кинетическую (= скорость). Под воздействием снятия напряжения жидкости, при выходе из форсунки, производится пластинка жидкости, изначально плоская, которая постепенно становится волнистой, утрачивая стабильность. Таким образом создаются жидкостные полоски, распадающиеся в капли разных размеров.

Технические характеристики

Эксплуатационные характеристики форсунок для сельского хозяйства Geoline приведены в соответствии с указаниями, предусмотренными международными стандартами, и включают следующие сведения:

- тип форсунки
- угол распыления
- размеры головки

Форсунки Geoline оснащены цветной кодировкой ISO: каждому цвету соответствует определенный расход.

Покрывание

Теоретическое покрытие параметра форсунки определяется, главным образом, углом и высотой распыления, то есть расстоянием между форсункой и обрабатываемой поверхностью.

В зависимости от высоты форсунки и ее размеров, угол распыления и точность распределения могут зависеть определенным образом от давления распыления. Рекомендованное давление распыления на головке форсунки и минимальная высота распыления для определенного расстояния между форсунками, представляют собой два требования, обеспечивающие равномерное распределение жидкости в соответствии с предусмотренной конфигурацией.

Применяются следующие физические законы (данные таблицы соответствуют воде):

- Распыляемые жидкости с вязкостью, превышающей вязкость воды, имеют меньшие углы распыления.
- Распыляемые жидкости с меньшим поверхностным напряжением по сравнению с напряжением воды, имеют более широкие углы распыления.
- Плотность распыляемой жидкости имеет ограниченное воздействие на угол распыления.

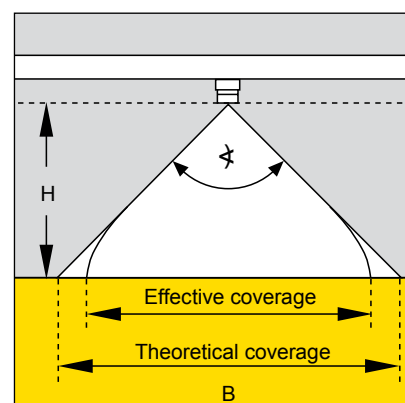

Copertura : Copertura teorica rapportata all'altezza dello spruzzo e all'angolo di spruzzo

Coverage : Theoretical coverage as a function of spray height and spray angle

Покрытие : Теоретическое покрытие соответствует высоте распыления и углу распыления

Spray angle	Theoretical coverage B for different spray heights H (cm)											
	10	15	20	25	30	40	50	60	70	80	100	120
20°	3.5	5.3	7.1	8.8	10.6	14.1	7.6	1.2	24.7	28.2	35.3	42.0
30°	5.4	8.0	10.7	13.4	16.1	21.4	26.8	32.2	37.5	42.9	53.6	64.0
45°	8.3	12.4	16.6	20.7	24.9	33.1	41.4	49.7	58.0	66.3	82.8	99.0
60°	11.6	17.3	23.1	28.9	34.6	46.2	57.7	69.3	80.8	92.4	115.0	(138.0*)
90°	20.0	30.0	40.0	50.0	60.0	80.0	100.0	120.0	140.0	160.0	200.0	(240.0*)
120°	34.6	52.0	69.3	86.6	104.0	139.0	173.0	208.0	242.0	277.0	(346.0*)	(416.0*)
140°	55.0	82.4	110.0	137.0	165.0	220.0	275.0	(330.0*)	(385.0*)	(440.0*)	(550.0*)	(660.0*)

* Dati tra parentesi: maggior differenza tra l'area di copertura effettiva e teorica.

* Parenthesized data: major difference between effective and theoretical coverage.

* Данные в скобках: наибольшая разница между эффективной и теоретической площадью покрытия

Parametri di applicazione

I dati applicativi nelle tabelle del presente catalogo sono stati calcolati per sistemi di polverizzazione diffusa con irroratrici a barre e un interasse tra gli ugelli pari a A = 50 cm. Le formule riportate a fianco si possono usare per calcolare le portate per altri intervalli tra gli ugelli.

Di regola, tre dei quattro parametri di applicazione – velocità di trattamento [km/h], dosaggio litri per ettaro [l/ha], portata [l/min], ed interasse tra gli ugelli [cm] – sono noti. I parametri che solitamente sono sconosciuti [l/min; l/ha] si calcolano con le formule riportate a fianco.

Il dosaggio effettivo per coltivazioni a filare, è in funzione del rapporto tra l'intera area realmente trattata, e l'area totale coperta. Il dosaggio reale applicato alla coltivazione, ammonta quindi ad una percentuale (per es. 40%) dell'intero dosaggio distribuito sull'area totale.

Application parameters

The application data in the tables of this catalogue were calculated for broadcast boom sprayers with a lateral nozzle spacing of A = 50 cm. The formulae at right can be used for calculating flow rates for other nozzle spacings.

As a rule, three of the four application parameters – sprayer speed [km/h], liter per hectare rate [l/ha], flow rate [l/min], and nozzle spacing [cm] – are known. The most frequently unknown parameters [l/min; l/ha] are also calculated according to the formulae shown at right.

The actual dosage for banding/row spraying is a function of the ratio between the treated (sprayed) area and the total gross covered area. The specific reduced dosage (liter per gross covered hectare), therefore amounts to a percentage (e.g., 40%) of the full rate per hectare for broadcast spraying.

Параметры применения

Данные таблиц настоящего каталога были рассчитаны для систем распыления при использовании штанг с межосевым расстоянием между форсунками A = 50 см. Приведенные с боковой стороны формулы могут использоваться для расчета расходов для других интервалов между форсунками. Как правило, три из четырех параметров – скорость обработки [км/ч], дозировка литров на гектар [л/га], расход [л/мин], и расстояние между форсунками [см] – известны. Параметры, которые, как правило, неизвестны [л/мин; л/га] рассчитываются с приведенными с боковой стороны формулами.

Эффективная дозировка для культиваций в рядах, зависит от соотношения фактически обработанной площади и общей площади. Фактическая дозировка культивации обусловлена процентом (например, 40%) всей дозировки общей площади.

Liter per hectare rate, M (l/ha) $M = \frac{600 \times \dot{V}}{A \times v_F}$	Sample for calculation of flow rate per nozzle: A = 1 m, v _F = 6km/h, M = 400l/ha
Flow rate / nozzle, \dot{V} (l/min) $\dot{V} = \frac{1}{600} \times M \times A \times v_F$	$\dot{V} = \frac{400 \times 1 \times 6}{600} = 4l/min$
Lateral nozzle spacing, A (m) Sprayer speed, v _F (km/h)	
Band width B [m] Lateral nozzle spacing or row spacing A [m]	
$\frac{B}{A} \times 100 = \text{treated (sprayed) area as a percentage of total gross covered area}$	
Example: $\frac{0,2}{0,5} \times 100 = 40\%$	

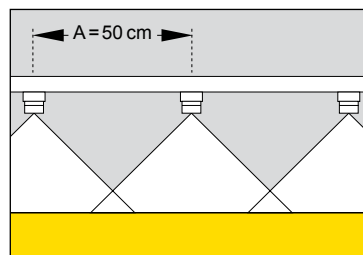

Materiali degli ugelli

La maggior parte degli ugelli per agricoltura è realizzata in plastica (POM), acciaio inossidabile, ceramica e, in alcuni casi, ottone.

Tutti questi materiali sono resistenti ai prodotti chimici noti per la protezione delle piante e tutti, ad eccezione dell'ottone, sono resistenti ai fertilizzanti liquidi.

■ La plastica si distingue per l'elevata precisione, la resistenza all'usura e gli ottimi rapporti prestazioni-prezzo.

■ L'acciaio inossidabile è il materiale ideale per carichi meccanici elevati.

■ Gli ugelli in ceramica sono i più resistenti in assoluto all'usura e quindi sono consigliati per la loro durata di vita estremamente lunga e per le elevate prestazioni specifiche sull'area.

Spray tip materials

Most agricultural spray nozzles are made of plastic (POM), stainless steel, ceramic and, in some cases, brass.

All these materials are resistant to known plant protection chemicals, and all with the exception of brass are resistant to liquid fertilizers.

■ Plastic is conspicuous for high precision, resistance to wear and very good price-performance ratios.

■ Stainless steel is the material of choice for high mechanical loads.

■ Ceramic nozzles are the most wear-resistant of all and therefore recommended for their extremely long service lives and high area specific performance.

Материалы форсунок

Большая часть форсунок для сельского хозяйства выполнена из пластика (POM), нержавеющей стали, керамики и латуни.

Все эти материалы устойчивы к воздействию химических средств для защиты растений, и все, за исключением латуни, устойчивы к воздействию жидких удобрений.

■ Пластик характеризуется высокой точностью, износостойкостью и превосходным соотношением параметров-цены.

■ Нержавеющая сталь представляет собой идеальный материал для высоких механических нагрузок.

■ Керамические форсунки являются наиболее устойчивыми в отношении изнашивания, поэтому рекомендуются.



CERAMIC



1÷4 bar

BD



SERIE BD "BASSA DERIVA"

Ugelli per uso a pieno campo senza induzione d'aria

Caratteristiche

- Realizzati in ceramica, con un contenuto di Allumina del 99%;
- Pressione consigliata da 1 a 4 bar
- Angolo di 80° o 110°;
- Indicato per erbicidi, insetticidi e fungicidi.

BD SERIES "LOW DRIFT"

Nozzles for full-field use without air induction

Features

- Made in ceramic with a 99% alumina content;
- Pressure recommended ranges from 1 to 4 bar;
- 80° or 110° angle;
- Suitable for herbicides, insecticides and fungicides.

СЕРИЯ BD « МАЛЫЙ СНОС »

Форсунки для полевых опрыскивателей без подачи воздуха

Характеристики

- Из керамики, с содержанием алюминия 99%.
- Рекомендуемое давление от 1 до 4 бар.
- Угол от 80° до 110°.
- Рекомендуется для гербицидов, инсектицидов и фунгицидов.

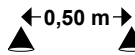
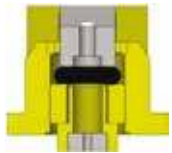

NOZZLE SPACING 0,50 m - Spraying Volume (L/Ha)

Part No.	Type	bar	psi	VMD	l/min	NOZZLE SPACING 0,50 m - Spraying Volume (L/Ha)												
						4	5	6	7	8	9	10	12	14	16	18	20	25
8259475 8259360	BD 80 - 01	1	15	F	0,22	66	53	44	38	33	29	26	22	19	17	15	13	11
		2	30	F	0,32	96	77	64	55	48	43	38	32	27	24	21	19	15
	BD 110 - 01	3	45	F	0,41	123	98	82	70	62	55	49	41	35	31	27	25	20
		4	60	F	0,46	138	110	92	79	69	61	55	46	39	35	31	28	22
8259476 8259361	BD 80 - 015	1	15	M	0,36	108	86	72	62	54	48	43	36	31	27	24	22	17
		2	30	F	0,50	150	120	100	86	75	67	60	50	43	38	33	30	24
	BD 110 - 015	3	45	F	0,61	183	146	122	105	92	81	73	61	52	46	41	37	29
		4	60	F	0,70	210	168	140	120	105	93	84	70	60	53	47	42	34
8259477 8259362	BD 80 - 02	1	15	M	0,48	144	115	96	82	72	64	58	48	41	36	32	29	23
		2	30	F	0,66	198	158	132	113	99	88	79	66	57	50	44	40	32
	BD 110 - 02	3	45	F	0,82	246	197	164	141	123	109	98	82	70	62	55	49	39
		4	60	F	0,95	285	228	190	163	143	127	114	95	81	71	63	57	46
8259478 8259363	BD 80 - 03	1	15	M	0,72	216	173	144	123	108	96	86	72	62	54	48	43	35
		2	30	M	1,00	300	240	200	171	150	133	120	100	86	75	67	60	48
	BD 110 - 03	3	45	F	1,25	375	300	250	214	188	167	150	125	107	94	83	75	60
		4	60	F	1,43	429	343	286	245	215	191	172	143	123	107	95	86	69
8259479 8259364	BD 80 - 04	1	15	M	0,96	288	230	192	165	144	128	115	96	82	72	64	58	46
		2	30	M	1,32	396	317	264	226	198	176	158	132	113	99	88	79	63
	BD 110 - 04	3	45	F	1,62	486	389	324	278	243	216	194	162	139	122	108	97	78
		4	60	F	1,89	567	454	378	324	284	252	227	189	162	142	126	113	91
8259480 8259365	BD 80 - 05	1	15	G	1,20	360	288	240	206	180	160	144	120	103	90	80	72	58
		2	30	M	1,67	501	401	334	286	251	223	200	167	143	125	111	100	80
	BD 110 - 05	3	45	F	2,07	621	497	414	355	311	276	248	207	177	155	138	124	99
		4	60	F	2,39	717	574	478	410	359	319	287	239	205	179	159	143	115
8259481 8259366	BD 80 - 06	1	15	G	1,44	432	346	288	247	216	192	173	144	123	108	96	86	69
		2	30	M	2,02	606	485	404	346	303	269	242	202	173	152	135	121	97
	BD 110 - 06	3	45	F	2,49	747	598	498	427	374	332	299	249	213	187	166	149	120
		4	60	F	2,86	858	686	572	490	429	381	343	286	245	215	191	172	137
8259482 8259367	BD 80 - 08	1	15	G	1,88	564	451	376	322	282	251	226	188	161	141	125	113	90
		2	30	M	2,77	831	665	554	475	416	369	332	277	237	208	185	166	133
	BD 110 - 08	3	45	F	3,37	1011	809	674	578	506	449	404	337	289	253	225	202	162
		4	60	F	3,86	1158	926	772	662	579	515	463	386	331	290	257	232	185
8259483 8259368	BD 80 - 80005	1	15	F	0,14	42	34	28	24	21	19	17	14	12	11	9	8	7
		2	30	F	0,18	54	43	36	31	27	24	22	18	15	14	12	11	9
	BD 110 - 50005	3	45	F	0,21	63	50	42	36	32	28	25	21	18	16	14	13	10
		4	60	F	0,23	69	55	46	39	35	31	28	23	20	17	15	14	11

OPTIONALS



Pag. 293



Pag. 254-255

8253000	red
8253001	yellow
8253002	green
8253003	blue
8253041	white
8253042	orange
8253043	brown
8253048	black
8253118	grey
8253119	violet

AD



CERAMIC



2÷4 bar



Generalitat de Catalunya
Departament d'Agricultura
Alimentació i Acció Rural



SERIE AD "ANTI DERIVA"

Ugelli per uso a pieno campo senza induzione d'aria

Caratteristiche

- Realizzati in ceramica, con un contenuto di Allumina del 99%;
- Pressione consigliata da 2 a 4 bar;
- Angolo di 110°;
- Indicato per erbicidi, insetticidi e fungicidi;
- La grandezza delle gocce riduce in parte la deriva.

AD SERIES "ANTI-DRIFT"

Nozzles for full-field use without air induction

Features

- Made in ceramic with a 99% alumina content;
- Pressure recommended ranges from 2 to 4 bar;
- 110° angle;
- Suitable for herbicides, insecticides and fungicides;
- The size of the drops partly reduces drift.

СЕРИЯ АД « С ЗАЩИТОЙ ОТ СНОСА »

Форсунки для полевых опрыскивателей без подачи воздуха

Характеристики

- Из керамики, с содержанием алюминия 99%.
- Рекомендуемое давление от 2 до 4 бар.
- Угол 110°
- Рекомендуется для гербицидов, инсектицидов и фунгицидов;
- Величина капель частично снижает снос;

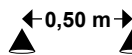

NOZZLE SPACING 0,50 m - SPRAYING VOLUME (l/ha)

Part No.	Type	bar	psi	VMD	l/min	NOZZLE SPACING 0,50 m - SPRAYING VOLUME (l/ha)												
						4 Km/h	5 Km/h	6 Km/h	7 Km/h	8 Km/h	9 Km/h	10 Km/h	12 Km/h	14 Km/h	16 Km/h	18 Km/h	20 Km/h	25 Km/h
8259354	AD 01	2	30	M	0,32	96	77	64	55	48	43	38	32	27	24	21	19	15
		3,1	45	F	0,41	123	98	82	70	62	55	49	41	35	31	27	25	20
		4,1	60	F	0,46	138	110	92	79	69	61	55	46	39	35	31	28	22
8259355	AD 015	2	30	M	0,50	150	120	100	86	75	67	60	50	43	38	33	30	24
		3,1	45	F	0,61	183	146	122	105	92	81	73	61	52	46	41	37	29
		4,1	60	F	0,70	210	168	140	120	105	93	84	70	60	53	47	42	34
8259356	AD 02	2	30	M	0,66	198	158	132	113	99	88	79	66	57	50	44	40	32
		3,1	45	M	0,82	246	197	164	141	123	109	98	82	70	62	55	49	39
		4,1	60	F	0,92	276	221	184	158	138	123	110	92	79	69	61	55	44
8259357	AD 03	2	30	M	1,00	300	240	200	171	150	133	120	100	86	75	67	60	48
		3,1	45	M	1,25	375	300	250	214	188	167	150	125	107	94	83	75	60
		4,1	60	M	1,43	429	343	286	245	215	191	172	143	123	107	95	86	69
8259358	AD 04	2	30	M	1,32	396	317	264	226	198	176	158	132	113	99	88	79	63
		3,1	45	M	1,62	486	389	324	278	243	216	194	162	139	122	108	97	78
		4,1	60	M	1,89	567	454	378	324	284	252	227	189	162	142	126	113	91
8259359	AD 05	2	30	G	1,67	501	401	334	286	251	223	200	167	143	125	111	100	80
		3,1	45	M	2,07	621	497	414	355	311	276	248	207	177	155	138	124	99
		4,1	60	M	2,39	717	574	478	410	359	319	287	239	205	179	159	143	115

OPTIONALS



Pag. 293

Pag. 254-255

8253000	red
8253001	yellow
8253002	green
8253003	blue
8253041	white
8253042	orange
8253043	brown
8253048	black
8253118	grey
8253119	violet

AZ



PLASTIC (POM)



SERIE AZ "ANTI DERIVA" - Ugelli per uso a pieno campo senza induzione d'aria

Caratteristiche

- Realizzati in resina acetlica;
- Pressione consigliata da 2 a 4 bar;
- Angolo di 80°-110°;
- È possibile lavorare con la barra del nebulizzatore più vicina al punto da irrorare;
- Indicato per erbicidi, insetticidi e fungicidi;
- La grandezza delle gocce ne riduce in parte la deriva.

AZ SERIES "ANTI-DRIFT" - Nozzles for full-field use without air induction

Features

- Made in acetal resin;
- Pressure recommended ranges from 2 to 4 bar;
- 80° - 110° angle;
- It is possible to work with the mist blower boom closer to the point to spray;
- Suitable for herbicides, insecticides and fungicides;
- The size of the drops partly reduces its drift.

СЕРИЯ AZ « С ЗАЩИТОЙ ОТ СНОСА »
Форсунки для полевых опрыскивателей без подачи воздуха

Характеристики

- Из ацетальной смолы.
- Рекомендуемое давление от 2 до 4 бар.
- Угол от 80° до 110°.
- Можно работать с штангой распылителя, ближайшей к точке орошения;
- Рекомендуется для гербицидов, инсектицидов и фунгицидов;
- Величина капель частично снижает снос

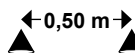

SPRAYING VOLUME (l/ha)

Part No.	Part No.	Type	SPRAYING VOLUME (l/ha)																	
			bar	psi	l/min	4 Km/h	5 Km/h	6 Km/h	7 Km/h	8 Km/h	9 Km/h	10 Km/h	12 Km/h	14 Km/h	16 Km/h	18 Km/h	20 Km/h	25 Km/h		
8261041 8261042	8259534 8259541	AZ 110-01 AZ 80-01	2	30	0,32	96	76,8	64	54,9	48	38,4	32	24	21,3	19,2	15,4	12,8	11		
			3	43	0,39	117	93,6	78	66,9	58,5	46,8	39	29,3	26	23,4	18,7	15,6	13,4		
			3,5	5,1	0,42	126	101	84	72	63	50,4	42	31,5	28	25,2	20,2	16,8	14,4		
			4	58	0,45	135	108	90	77,1	67,5	54	45	33,8	30	27	21,6	18	15,4		
8261043 8261044	8259535 8259542	AZ 110-015 AZ 80-015	2,5	36	0,54	162	130	108	92,6	81	64,8	54	40,5	36	32,4	25,9	21,6	18,5		
			3	43	0,59	177	142	118	101	88,5	70,8	59	44,3	39,3	35,4	28,3	23,6	20,2		
			3,5	5,1	0,64	192	154	128	110	96	76,8	64	48	42,7	38,4	30,7	25,6	21,9		
			4	58	0,68	204	163	136	117	102	81,6	68	51	45,3	40,8	32,6	27,2	23,3		
8261045 8261046	8259536 8259543	AZ 110-02 AZ 80-02	2	30	0,65	195	156	130	111	97,5	78	65	48,8	43,3	39	31,2	26	22,3		
			2,5	36	0,72	216	173	144	123	108	86,4	72	54	48	43,2	34,6	28,8	24,7		
			3	43	0,79	237	190	158	135	119	94,8	79	59,3	52,7	47,4	37,9	31,6	27,1		
			3,5	5,1	0,85	255	204	170	146	128	102	85	63,8	56,7	51	40,8	34	29,1		
8261047 8261048	8259537 8259544	AZ 110-03 AZ 80-03	4	58	0,91	273	218	182	156	137	109	91	68,3	60,7	54,6	43,7	36,4	31,2		
			2	30	0,96	288	230	192	165	144	115	96	72	64	57,6	46,1	38,4	32,9		
			2,5	36	1,08	324	259	216	185	162	130	108	81	72	64,8	51,8	43,2	37		
			3	43	1,18	354	283	236	202	177	142	118	88,5	78,7	70,8	56,6	47,2	40,5		
8261049 8261050	8259538 8259545	AZ 110-04 AZ 80-04	3,5	5,1	1,27	381	305	254	218	191	152	127	95,3	84,7	76,2	61	50,8	43,5		
			4	58	1,36	408	326	272	233	204	163	136	102	90,7	81,6	65,3	54,4	46,6		
			2	30	1,29	387	310	258	221	194	155	129	96,8	86	77,4	61,9	51,6	44,2		
			2,5	36	1,44	432	346	288	247	216	173	144	108	96	86,4	69,1	57,6	49,4		
8261051 8261052	8259539 8259546	AZ 110-05 AZ 80-05	3	43	1,58	474	379	316	271	237	190	158	119	105	94,8	75,8	63,2	54,2		
			3,5	5,1	1,71	513	410	342	293	257	205	171	128	114	103	82,1	68,4	58,6		
			4	58	1,82	546	437	364	312	273	218	182	137	121	109	87,4	72,8	62,4		
			2	30	1,61	483	386	322	276	242	193	161	121	107	96,6	77,3	64,4	55,2		
8261053 8261054	8259540 8259547	AZ 110-06 AZ 80-06	2,5	36	1,8	540	432	360	309	270	216	180	135	120	108	86,4	72	61,7		
			3	43	1,97	591	473	394	338	296	236	197	148	131	118	94,6	78,8	67,5		
			3,5	5,1	2,13	639	511	426	365	320	256	213	160	142	128	102	85,2	73		
			4	58	2,27	681	545	454	389	341	272	227	170	151	136	109	90,8	77,8		
8253000	red	8261053 8261054	8259540 8259547	AZ 110-06 AZ 80-06	2	30	1,94	582	466	388	333	291	233	194	146	129	116	93,1	77,6	66,5
					2,5	36	2,16	648	518	432	370	324	259	216	162	144	130	104	86,4	74,1
					3	43	2,37	711	569	474	406	356	284	237	178	158	142	114	94,8	81,3
					3,5	5,1	2,56	768	614	512	439	384	307	256	192	171	154	123	102	87,8
8253001	yellow	8261053 8261054	8259540 8259547	AZ 110-06 AZ 80-06	4	58	2,74	822	658	548	470	411	329	274	206	183	164	132	110	93,9

OPTIONALS



Pag. 293



Pag. 254-255

8253000	red
8253001	yellow
8253002	green
8253003	blue
8253041	white
8253042	orange
8253043	brown
8253048	black
8253118	grey
8253119	violet

ADGA



CERAMIC



2÷4 bar

SERIE ADGA "ANTI DERIVA" AD ANGOLO GRANDE - Ugelli per uso a pieno campo senza induzione d'aria

Caratteristiche

- Realizzati in ceramica, con un contenuto di Allumina del 99%;
- Pressione consigliata da 2 a 4 bar;
- Angolo di 120°;
- È possibile lavorare con la barra del nebulizzatore più vicina al punto da irrorare;
- Indicato per erbicidi, insetticidi e fungicidi;
- La grandezza delle gocce ne riduce in parte la deriva.

ADGA SERIES WIDE ANGLE "ANTI-DRIFT" - Nozzles for full-field use without air induction

Features

- Made in ceramic with a 99% alumina content;
- Pressure recommended ranges from 2 to 4 bar;
- 120° angle;
- It is possible to work with the mist blower boom closer to the point to spray;
- Suitable for herbicides, insecticides and fungicides;
- The size of the drops partly reduces its drift.

СЕРИЯ ADGA « С ЗАЩИТОЙ ОТ СНОСА» С ШИРОКИМ УГЛОМ - Форсунки для полевых опрыскивателей без подачи воздуха

Характеристики

- Из керамики с содержанием алюминия 99%.
- Рекомендуемое давление от 2 до 4 бар.
- Угол 120°.
- Можно работать с штангой распылителя, ближайшей к точке орошения.
- Рекомендуется для гербицидов, инсектицидов и фунгицидов.
- Величина капель частично снижает снос.

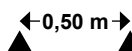

NOZZLE SPACING 0,50 m - SPRAYING VOLUME (l/ha)

Part No.	Type	bar	psi	VMD	l/min	NOZZLE SPACING 0,50 m												
						4 Km/h	5 Km/h	6 Km/h	7 Km/h	8 Km/h	9 Km/h	10 Km/h	12 Km/h	14 Km/h	16 Km/h	18 Km/h	20 Km/h	25 Km/h
8259435	ADGA 01	1	15	M	0,22	66	53	44	38	33	29	26	22	19	17	15	13	11
		2	30	F	0,32	96	77	64	55	48	43	38	32	27	24	21	19	15
		3,1	45	F	0,41	123	98	82	70	62	55	49	41	35	31	27	25	20
		4,1	60	F	0,46	138	110	92	79	69	61	55	46	39	35	31	28	22
8259436	ADGA 015	1	15	M	0,36	108	86	72	62	54	48	43	36	31	27	24	22	17
		2	30	F	0,50	150	120	100	86	75	67	60	50	43	38	33	30	24
		3,1	45	F	0,61	183	146	122	105	92	81	73	61	52	46	41	37	29
8259437	ADGA 02	1	15	M	0,48	144	115	96	82	72	64	58	48	41	36	32	29	23
		2	30	M	0,66	198	158	132	113	99	88	79	66	57	50	44	40	32
		3,1	45	F	0,82	246	197	164	141	123	109	98	82	70	62	55	49	39
8259438	ADGA 03	1	15	M	0,72	216	173	144	123	108	96	86	72	62	54	48	43	35
		2	30	M	1,00	300	240	200	171	150	133	120	100	86	75	67	60	48
		3,1	45	M	1,25	375	300	250	214	188	167	150	125	107	94	83	75	60
8259439	ADGA 04	1	15	M	0,96	288	230	192	165	144	128	115	96	82	72	64	58	46
		2	30	M	1,32	396	317	264	226	198	176	158	132	113	99	88	79	63
		3,1	45	M	1,62	486	389	324	278	243	216	194	162	139	122	108	97	78
		4,1	60	M	1,89	567	454	378	324	284	252	227	189	162	142	126	113	91

OPTIONALS



Pag. 293

Pag. 254-255

8253000	red
8253001	yellow
8253002	green
8253003	blue
8253041	white
8253042	orange
8253043	brown
8253048	black
8253118	grey
8253119	violet



CERAMIC



AD-IA



SERIE AD-IA "ANTI DERIVA" A INDUZIONE D'ARIA
Ugelli per uso a pieno campo a induzione d'aria

Caratteristiche

- Realizzati in ceramica, con un contenuto di Allumina del 99%;
- Pressione consigliata da 2 a 7.5 bar;
- Angolo di 80° - 110°;
- Dispone di un sistema Venturi a induzione d'aria nelle gocce, che consente a queste ultime di raggiungere grandi dimensioni, anche alle pressioni più elevate;
- Permette di lavorare con venti che raggiungono i 20 km/h.

AD-IA SERIES "AIR INDUCTION "ANTI-DRIFT"
Air induction nozzles for full-field use

Features

- Made in ceramic with a 99% alumina content;
- Pressure recommended ranges from 2 to 7.5 bar;
- 80° - 110° angle;
- It has a Venturi air induction system for the drops so they can become very big even at high pressures;
- It can be used even with 20 km/h winds.

СЕРИЯ AD-IA С ЗАЩИТОЙ ОТ СНОСА С ПОДАЧЕЙ ВОЗДУХА - Форсунки для полевых опрыскивателей с подачей воздуха

Характеристики

- Из керамики с содержанием алюминия 99%.
- Рекомендуемое давление от 2 до 7,5 бар.
- Угол от 80° до 110°.
- Располагает системой Вентури с подачей воздуха в каплях, что позволяет им достигать больших размеров, даже при высоком давлении.
- Возможность работы при ветре до 20 км/ч.



Part No.	Type	bar	psi	VMD	l/min	NOZZLE SPACING 0,50 m - SPRAYING VOLUME (l/ha)															
						4 Km/h	5 Km/h	6 Km/h	7 Km/h	8 Km/h	9 Km/h	10 Km/h	12 Km/h	14 Km/h	16 Km/h	18 Km/h	20 Km/h	25 Km/h			
8259471 8259346	AD-IA 80 - 01 AD-IA 110 - 01	2	30	EG	0,38	114	91	76	65	57	51	46	38	33	29	25	23	18			
		3,4	50	MG	0,43	129	103	86	74	65	57	52	43	37	32	29	26	21			
		4,8	70	MG	0,50	150	120	100	86	75	67	60	50	43	38	33	30	24			
		6,2	90	G	0,56	168	134	112	96	84	75	67	56	48	42	37	34	27			
		7,6	110	G	0,62	186	149	124	106	93	83	74	62	53	47	41	37	30			
8259472 8259347	AD-IA 80 - 015 AD-IA 110 - 015	2	30	EG	0,48	144	115	96	82	72	64	58	48	41	36	32	29	23			
		3,4	50	MG	0,65	195	156	130	111	98	87	78	65	56	49	43	39	31			
		4,8	70	MG	0,77	231	185	154	132	116	103	92	77	66	58	51	46	37			
		6,2	90	MG	0,86	258	206	172	147	129	115	103	86	74	65	57	52	41			
		7,6	110	G	0,95	285	228	190	163	143	127	114	95	81	71	63	57	46			
8259473 8259348	AD-IA 80 - 02 AD-IA 110 - 02	2	30	EG	0,67	201	161	134	115	101	89	80	67	57	50	45	40	32			
		3,4	50	EG	0,89	267	214	178	153	134	119	107	89	76	67	59	53	43			
		4,8	70	MG	1,04	312	250	208	178	156	139	125	104	89	78	69	62	50			
		6,2	90	MG	1,18	354	283	236	202	177	157	142	118	101	89	79	71	57			
		7,6	110	G	1,29	387	310	258	221	194	172	155	129	111	97	86	77	62			
8259474 8259349	AD-IA 80 - 025 AD-IA 110 - 025	2	30	EG	0,83	249	199	166	142	125	111	100	83	71	62	55	50	40			
		3,4	50	EG	1,09	327	262	218	187	164	145	131	109	93	82	73	65	52			
		4,8	70	MG	1,29	387	310	258	221	194	172	155	129	111	97	86	77	62			
		6,2	90	MG	1,46	438	350	292	250	219	195	175	146	125	110	97	88	70			
		7,6	110	G	1,61	483	386	322	276	242	215	193	161	138	121	107	97	77			
8259350	AD-IA 110 - 03	2	30	EG	1,01	303	242	202	173	152	135	121	101	87	76	67	61	48			
		3,4	50	EG	1,33	399	319	266	228	200	177	160	133	114	100	89	80	64			
		4,8	70	MG	1,58	474	379	316	271	237	211	190	158	135	119	105	95	76			
		6,2	90	MG	1,80	540	432	360	309	270	240	216	180	154	135	120	108	86			
		7,6	110	MG	1,97	591	473	394	338	296	263	236	197	169	148	131	118	95			
8259351	AD-IA 110 - 04	2	30	EG	1,33	399	319	266	228	200	177	160	133	114	100	89	80	64			
		3,4	50	EG	1,73	519	415	346	297	260	231	208	173	148	130	115	104	83			
		4,8	70	MG	2,06	618	494	412	353	309	275	247	206	177	155	137	124	99			
		6,2	90	MG	2,32	696	557	464	398	348	309	278	232	199	174	155	139	111			
		7,6	110	MG	2,57	771	617	514	441	386	343	308	257	220	193	171	154	123			
8259352	AD-IA 110 - 05	2	30	EG	1,64	492	394	328	281	246	219	197	164	141	123	109	98	79			
		3,4	50	EG	2,14	642	514	428	367	321	285	257	214	183	161	143	128	103			
		4,8	70	EG	2,56	768	614	512	439	384	341	307	256	219	192	171	154	123			
		6,2	90	MG	2,87	861	689	574	492	431	383	344	287	246	215	191	172	138			
		7,6	110	MG	3,17	951	761	634	543	476	423	380	317	272	238	211	190	152			
8259353	AD-IA 110 - 06	2	30	EG	2,00	600	480	400	343	300	267	240	200	171	150	133	120	96			
		3,4	50	EG	2,57	771	617	514	441	386	343	308	257	220	193	171	154	123			
		4,8	70	EG	3,03	909	727	606	519	455	404	364	303	260	227	202	182	145			
		6,2	90	MG	3,53	1059	847	706	605	530	471	424	353	303	265	235	212	169			
		7,6	110	MG	3,85	1155	924	770	660	578	513	462	385	330	289	257	231	185			

OPTIONALS



Pag. 293



Pag. 254-255

8253028	red
8253029	yellow
8253030	green
8253031	blue
8253069	orange
8253070	brown
8253071	black
8253126	white
8253127	light blue
8253128	violet

AD-IA/D



CERAMIC



2÷7,5 bar

SERIE AD-IA/D "ANTI DERIVA" A INDUZIONE D'ARIA - DOPPIO - Ugelli per uso a pieno campo a induzione d'aria

Caratteristiche

- Realizzati in ceramica, con un contenuto di Allumina del 99%;
- Pressione consigliata da 2 a 7.5 bar;
- Consente una migliore penetrazione nel punto da irrorare;
- Angolo di 110° di apertura e 40° tra i ventagli;
- Permette di lavorare con venti che raggiungono i 20 km/h.

AD-IA/D SERIES DOUBLE "AIR INDUCTION "ANTI-DRIFT" - Air induction nozzles for full-field use

Features

- Made in ceramic with a 99% alumina content;
- Pressure recommended ranges from 2 to 7.5 bar;
- It gives a better coverage in the point to spray;
- 110° opening angle and 40° between fans;
- It can be used even with 20 km/h winds.

СЕРИЯ AD-IA/D « С ЗАЩИТОЙ ОТ СНОСА » С ПОДАЧЕЙ ВОЗДУХА - ДВОЙНАЯ - Форсунки для полевых опрыскивателей с подачей воздуха

Характеристики

- Из керамики с содержанием алюминия 99%.
- Рекомендуемое давление от 2 до 7,5 бар.
- Обеспечивает лучшее проникновение в точку орошения.
- Угол 110° открытия и 40° междулопастями.
- Возможность работы при ветре до 20 км/ч.

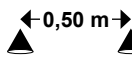

NOZZLE SPACING 0,50 m - SPRAYING VOLUME (l/ha)

Part No.	Type	bar		VMD	l/min	NOZZLE SPACING 0,50 m - SPRAYING VOLUME (l/ha)														
		psi	EG			4 Km/h	5 Km/h	6 Km/h	7 Km/h	8 Km/h	9 Km/h	10 Km/h	12 Km/h	14 Km/h	16 Km/h	18 Km/h	20 Km/h	25 Km/h		
8259410	AD-IA 01.D	2	30	EG	0,38	114	91	76	65	57	51	46	38	33	29	25	23	18		
		3,4	50	MG	0,43	129	103	86	74	65	57	52	43	37	32	29	26	21		
		4,8	70	MG	0,50	150	120	100	86	75	67	60	50	43	38	33	30	24		
		6,2	90	G	0,56	168	134	112	96	84	75	67	56	48	42	37	34	27		
8259411	AD-IA 015.D	2	30	EG	0,48	144	115	96	82	72	64	58	48	41	36	32	29	23		
		3,4	50	MG	0,65	195	156	130	111	98	87	78	65	56	49	43	39	31		
		4,8	70	G	0,77	231	185	154	132	116	103	92	77	66	58	51	46	37		
		6,2	90	G	0,86	258	206	172	147	129	115	103	86	74	65	57	52	41		
8259412	AD-IA 02.D	2	30	EG	0,67	201	161	134	115	101	89	80	67	57	50	45	40	32		
		3,4	50	MG	0,89	267	214	178	153	134	119	107	89	76	67	59	53	43		
		4,8	70	G	1,04	312	250	208	178	156	139	125	104	89	78	69	62	50		
		6,2	90	G	1,18	354	283	236	202	177	157	142	118	101	89	79	71	57		
8259413	AD-IA 025.D	2	30	EG	0,83	249	199	166	142	125	111	100	83	71	62	55	50	40		
		3,4	50	MG	1,09	327	262	218	187	164	145	131	109	93	82	73	65	52		
		4,8	70	G	1,29	387	310	258	221	194	172	155	129	111	97	86	77	62		
		6,2	90	G	1,46	438	350	292	250	219	195	175	146	125	110	97	88	70		
8259414	AD-IA 03.D	2	30	EG	1,01	303	242	202	173	152	135	121	101	87	76	67	61	48		
		3,4	50	MG	1,33	399	319	266	228	200	177	160	133	114	100	89	80	64		
		4,8	70	G	1,58	474	379	316	271	237	211	190	158	135	119	105	95	76		
		6,2	90	G	1,80	540	432	360	309	270	240	216	180	154	135	120	108	86		
8259415	AD-IA 04.D	2	30	EG	1,33	399	319	266	228	200	177	160	133	114	100	89	80	64		
		3,4	50	MG	1,73	519	415	346	297	260	231	208	173	148	130	115	104	83		
		4,8	70	MG	2,06	618	494	412	353	309	275	247	206	177	155	137	124	99		
		6,2	90	G	2,32	696	557	464	398	348	309	278	232	199	174	155	139	111		
8259416	AD-IA 05.D	2	30	EG	1,64	492	394	328	281	246	219	197	164	141	123	109	98	79		
		3,4	50	MG	2,14	642	514	428	367	321	285	257	214	183	161	143	128	103		
		4,8	70	MG	2,56	768	614	512	439	384	341	307	256	219	192	171	154	123		
		6,2	90	G	2,87	861	689	574	492	431	383	344	287	246	215	191	172	138		
8259417	AD-IA 06.D	2	30	EG	2,04	612	490	408	350	306	272	245	204	175	153	136	122	98		
		3,4	50	MG	2,60	780	624	520	446	390	347	312	260	223	195	173	156	125		
		4,8	70	MG	3,08	924	739	616	528	462	411	370	308	264	231	205	185	148		
		6,2	90	MG	3,44	1032	826	688	590	516	459	413	344	295	258	229	206	165		

OPTIONALS



Pag. 293



Pag. 254-255

8253028	red
8253029	yellow
8253030	green
8253031	blue
8253069	orange
8253070	brown
8253071	black
8253126	white
8253127	light blue
8253128	violet

AS-IA



CERAMIC



2÷7,6 bar

UGELLO "VENTURI" AS-IA A VENTAGLIO -
DOPPIO ASIMMETRICO
Ugelli a induzione d'aria

Caratteristiche

- Tutti i modelli sono realizzati in ceramica con un contenuto di allumina del 99%, corpo in Resina acetaleica.
- Pressione di lavoro consigliata: da 40 a 110 psi (da 2 a 7,6 bar)
- Due getti a ventaglio con angoli da 110°.
- Orientamento asimmetrico dei due spruzzi, appositamente progettato per velocità di applicazione più elevate, garantendo una migliore copertura e penetrazione nel punto da irrorare
- Spruzzo inclinato in avanti con angolo di 30° per una migliore penetrazione in colture con grande massa fogliare e spruzzo inclinato indietro con angolo di 70° che garantisce la massima copertura delle coltivazioni
- Foro di uscita più ampio che ne evita l'intasamento;
- Ugello a induzione d'aria (sistema Venturi): produzione di gocce di grandi dimensioni piene d'aria. Questo sistema permette di ridurre la deriva e migliorare la copertura.
- Pre-orifizio estraibile per una pulizia più semplice e veloce

AS-IA ASYMMETRIC DOUBLE FLAT SPRAY
VENTURI NOZZLE
Air induction nozzles

Features

- Made in ceramic with a 99% Alumina cinted, body in Acetal resin;
- Recommended working pressure: 40 to 110 psi (2 to 7.6 bar)
- Two flat fan patterns with 110° angles.
- Asymmetric orientation of the two spray patterns, especially designed for higher application speeds, providing better coverage and penetration to target
- 30° forward tilted spray which provides better penetration in crops with dense foliage, while the backward tilted 70° spray ensures maximum crop coverage
- Large orifice minimizes clogging;
- Air induction spray nozzle (ventury system): sprays large droplets filled with air. This system reduces the drift and improves coverage.
- Removable pre-orifice for fast and easy cleaning

ФОРСУНКА « ВЕНТУРИ» AS-IA С ДВОЙНОЙ АСИММЕТРИЧНОЙ ПЛОСКОЙ СТРУЕЙ

Форсунки с подачей воздуха

Хактеристики

- Все модели из керамики с содержанием алюминия 99%, корпус из ацетальной смолы.
- Рекомендуемое рабочее давление: от 40 до 110 фунт.кв.дюйм (от 2 до 7,6 бар)
- Две плоские струи с углами 110°.
- Асимметричная ориентировка двух струй, специально разработанная для высоких скоростей применения, гарантируя лучшее покрытие и проникновение в точке для орошения.
- Наклоненная вперед струя на 30° для лучшего проникновения в культуры с большой массой листьев и наклоненная назад струя под углом 70°, обеспечивающая максимальное покрытие.
- Большое выходное отверстие, предупреждающее засорение.
- Форсунка с подачей воздуха (система Вентури): производство капель больших размеров, наполненных воздухом. Эта система позволяет уменьшить снос и улучшить покрытие.
- Извлекаемое сопло для удобной и быстрой очистки.



←0,50 m→
NOZZLE SPACING 0,50 m - SPRAYING VOLUME (l/ha)

Part No.	Type	bar	psi	l/min	12 Km/h	14 Km/h	16 Km/h	18 Km/h	20 Km/h	25 Km/h
8259528	AS-IA 110-01	2	30	0,39	39	33	29	26	23	19
		3,4	50	0,44	44	38	33	29	26	21
		4,8	70	0,51	51	44	38	34	31	24
		6,2	90	0,58	58	50	44	39	35	28
		7,6	110	0,64	64	55	48	43	38	31
8259529	AS-IA 110-015	2	30	0,51	51	44	38	34	31	24
		3,4	50	0,65	65	56	49	43	39	31
		4,8	70	0,76	76	65	57	51	46	36
		6,2	90	0,87	87	75	65	58	52	42
8259530	AS-IA 110-02	2	30	0,66	66	57	50	44	40	32
		3,4	50	0,86	86	74	65	57	52	41
		4,8	70	1,00	100	86	75	67	60	48
		6,2	90	1,15	115	99	86	77	69	55
8259531	AS-IA 110-025	2	30	0,85	85	73	64	57	51	41
		3,4	50	1,07	107	92	80	71	64	51
		4,8	70	1,25	125	107	94	83	75	60
		6,2	90	1,45	145	124	109	97	87	70
8259532	AS-IA 110-03	2	30	1,01	101	87	76	67	61	48
		3,4	50	1,30	130	111	98	87	78	62
		4,8	70	1,53	153	131	115	102	92	73
		6,2	90	1,70	170	146	128	113	102	82
8259533	AS-IA 110-04	2	30	1,35	135	116	101	90	81	65
		3,4	50	1,75	175	150	131	117	105	84
		4,8	70	2,07	207	177	155	138	124	99
		6,2	90	2,35	235	201	176	157	141	113
		7,6	110	2,55	255	219	191	170	153	122

OPTIONALS



Pag. 293



Pag. 254-255

8253028	red
8253029	yellow
8253030	green
8253031	blue
8253069	orange
8253070	brown
8253071	black
8253126	white
8253127	light blue
8253128	violet

AD/T



CERAMIC



2,7-8,9 bar

SERIE AD/T "ANTI DERIVA" - TRIPLO - Ugelli per uso a pieno campo senza induzione d'aria

Caratteristiche

- Inserto in ceramica con un contenuto di Allumina del 99%.
- L'azione a tre getti piatti offre migliore copertura e penetrazione, anche in caso di densa massa fogliare.
- Indicato per tutti i trattamenti applicati con barra da diserbo: erbicidi, fungicidi e insetticidi.
- Tre getti piatti a ventaglio con angolo di 110°. L'angolazione tra i tre getti è di 40° in avanti, indietro e al centro.
- Pressione consigliata: da 2,8 a 9 bar.

AD/T SERIES TRIPLE "ANTI-DRIFT" - Nozzles for full-field use without air induction

Features

- Ceramic insert with an alumina content of 99%
- Triple spray action provides better coverage and penetration even in dense foliage
- Recommended for all types of treatments with boom sprayers: herbicides, fungicides and insecticides
- Three 110° angle flat fan spray patterns. Angle between each spray pattern is 40° forward, back and in the center
- Wider options of recommended working pressures: from 40 to 130 psi

СЕРИЯ AD/T « С ЗАЩИТОЙ ОТ СНОСА » - ТРОЙНАЯ - Форсунки для полевых опрыскивателей без подачи воздуха

Характеристики

- Вставка из керамики с содержанием алюминия 99%.
- Действие тремя плоскими струями обеспечивает лучшее покрытие и проникновение, даже при большом количестве листьев.
- Предусмотрена для всех видов обработки с штангами опрыскивателя: гербицидов, фунгицидов и инсектицидов.
- Три плоских струи под углом 110°. Угол между струями 40° впереди, сзади и по центру.
- Рабочее давление: от 2,8 до 9 бар.

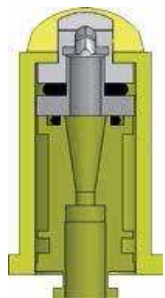

← 0,50 m →
NOZZLE SPACING 0,50 m - SPRAYING VOLUME (l/ha)

Part No.	Type	bar		psi		VMD		Kmh/h																
		2.8	4.1	4.1	6.0	l/min	4	5	6	7	8	9	10	12	15	18	20	22	25					
8259559	AD/T 110-02	2.8	40	F	0.76	228	182	152	130	114	101	91	76	61	51	46	41	36						
		3.4	50	F	0.85	255	204	170	146	128	113	102	85	68	57	51	46	41						
		4.1	60	F	0.92	276	221	184	158	138	123	110	92	74	61	55	50	44						
		4.8	70	F	1.00	300	240	200	171	150	133	120	100	80	67	60	55	48						
		6.2	90	MF	1.16	348	278	232	199	174	155	139	116	93	77	70	63	56						
		7.6	110	MF	1.22	366	293	244	209	183	163	146	122	98	81	73	67	59						
8259560	AD/T 110-025	2.8	40	F	0.98	294	235	196	168	147	131	118	98	78	65	59	53	47						
		3.4	50	F	1.05	315	252	210	180	158	140	126	105	84	70	63	57	50						
		4.1	60	F	1.14	342	274	228	195	171	152	137	114	91	76	68	62	55						
		4.8	70	F	1.21	363	290	242	207	182	161	145	121	97	81	73	66	58						
		6.2	90	F	1.36	408	326	272	233	204	181	163	136	109	91	82	74	65						
		7.6	110	MF	1.48	444	355	296	254	222	197	178	148	118	99	89	81	71						
8259561	AD/T 110-03	2.8	40	F	1.18	354	283	236	202	177	157	142	118	94	79	71	64	57						
		3.4	50	F	1.3	390	312	260	223	195	173	156	130	104	87	78	71	62						
		4.1	60	F	1.40	420	336	280	240	210	187	168	140	112	93	84	76	67						
		4.8	70	F	1.50	450	360	300	257	225	200	180	150	120	100	90	82	72						
		6.2	90	F	1.64	492	394	328	281	246	219	197	164	131	109	98	89	79						
		7.6	110	MF	1.80	540	432	360	309	270	240	216	180	144	120	108	98	86						
8259562	AD/T 110-04	2.8	40	M	1.58	474	379	316	271	237	211	190	158	126	105	95	86	76						
		3.4	50	F	1.70	510	408	340	291	255	227	204	170	136	113	102	93	82						
		4.1	60	F	1.84	552	442	368	315	276	245	221	184	147	123	110	100	88						
		4.8	70	F	1.98	594	475	396	339	297	264	238	198	158	132	119	108	95						
		6.2	90	F	2.14	642	514	428	367	321	285	257	214	171	143	128	117	103						
		7.6	110	F	2.30	690	552	460	394	345	307	276	230	184	153	138	125	110						
8259563	AD/T 110-05	2.8	40	M	1.97	591	473	394	338	296	263	236	197	158	131	118	107	95						
		3.4	50	F	2.14	642	514	428	367	321	285	257	214	171	143	128	117	103						
		4.1	60	F	2.30	690	552	460	394	345	307	276	230	184	153	138	125	110						
		4.8	70	F	2.45	735	588	490	420	368	327	294	245	196	163	147	134	118						
		6.2	90	F	2.70	810	648	540	463	405	360	324	270	216	180	162	147	130						
		7.6	110	F	2.92	876	701	584	501	438	389	350	292	234	195	175	159	140						
8259564	AD/T 110-06	2.8	40	M	1.98	594	475	396	339	297	264	238	198	158	132	119	108	95						
		3.4	50	M	2.62	786	629	524	449	393	349	314	262	210	175	157	143	126						
		4.1	60	F	2.80	840	672	560	480	420	373	336	280	224	187	168	153	134						
		4.8	70	F	3.00	900	720	600	514	450	400	360	300	240	200	180	164	144						
		6.2	90	F	3.30	990	792	660	566	495	440	396	330	264	220	198	180	158						
		7.6	110	F	3.60	1080	864	720	617	540	480	432	360	288	240	216	196	173						
8259565	AD/T 110-08	2.8	40	M	3.82	1146	917	764	655	573	509	458	382	306	255	229	208	183						
		2.8	40	M	3.10	930	744	620	531	465	413	372	310	248	207	186	169	149						
		3.4	50	M	3.40	1020	816	680	583	510	453	408	340	272	227	204	185	163						
		4.1	60	F	3.65	1095	876	730	626	548	487	438	365	292	243	219	199	175						
		4.8	70	F	3.90	1170	936	780	669	585	520	468	390	312	260	234	213	187						
		6.2	90	F	4.35	1305	1044	870	746	653	580	522	435	348	290	261	237	209						
8259566	AD/T 110-10	2.8	40	M	5.10	1530	1224	1020	874	765	680	612	510	408	340	306	278	245						
		3.4	50	M	3.88	1164	931	776	665	582	517	466	388	310	259	233	212	186						
		3.4	50	M	4.20	1260	1008	840	720	630	560	504	420	336	280	252	229	202						
		4.1	60	M	4.56	1368	1094	912	782	684	608	547	456	365	304	274	249	219						
		4.8	70	F	4.90	1470	1176	980	840	735	653	588	490	392	327	294	267	235						
		6.2	90	F	5.40	1620	1296	1080	926	810	720	648	540	432	360	324	295	259						
8253028	red	7.6	110	F	5.94	1782	1426	1188	1018	891	792	713	594	475	396	356	324	285						
		9	130	F	6.34	1902	1522	1268	1087	951	845	761	634	507	423	380	346	304						
8253126	white	7.6	110	F	5.94	1782	1426	1188	1018	891	792	713	594	475	396	356	324	285						
		9	130	F	6.34	1902	1522	1268	1087	951	845	761	634	507	423	380	346	304						
8253127	light blue	7.6	110	F	5.94	1782	1426	1188	1018	891	792	713	594	475	396	356	324	285						
		9	130	F	6.34	1902	1522	1268	1087	951	845	761	634	507	423	380	346	304						
8253128	violet	7.6	110	F	5.94	1782	1426	1188	1018	891	792	713	594	475	396	356	324	285						
		9	130	F	6.34	1902	1522	1268	1087	951	845	761	634	507	423	380	346	304						

OPTIONALS



Pag. 293



Pag. 254-255

8253028	red
8253029	yellow
8253030	green
8253031	blue
8253069	orange
8253070	brown
8253071	black
8253126	white
8253127	light blue
8253128	violet

AD/D



CERAMIC



2÷4 bar

SERIE AD/D "ANTI DERIVA" - DOPPIO
Ugelli per uso a pieno campo senza induzione d'aria

Caratteristiche

- Realizzati in ceramica, con un contenuto di Allumina del 99%;
- Pressione consigliata da 2 a 4 bar;
- Consente una migliore copertura della superficie fogliare e una migliore penetrazione nel punto da irrorare (o in colture con grande massa fogliare);
- Angolo di 110° di apertura e 40° tra i ventagli;
- Indicato per erbicidi, insetticidi e fungicidi.

AD/D SERIES DOUBLE "ANTI-DRIFT"
Nozzles for full-field use without air induction

Features

- Made in ceramic with a 99% alumina content;
- Pressure recommended ranges from 2 to 4 bar;
- It gives a better coverage of leaf surface and better penetration in the point to spray (or on crops with a mass of leaves);
- 110° opening angle and 40° between fans;
- Suitable for herbicides, insecticides and fungicides.

СЕРИЯ AD/D « С ЗАЩИТОЙ ОТ СНОСА » - ДВОЙНАЯ

Форсунки для полевых опрыскивателей без подачи воздуха

Характеристики

- Из керамики с содержанием алюминия 99%.
- Рекомендуемое давление от 2 до 4 бар.
- Обеспечивает лучшее покрытие поверхности листьев и лучшее проникновение в точку орошения (или в культурах с большой массой листьев).
- Угол 110° открытия и 40° между лопастями
- Предусмотрен для гербицидов, инсектицидов и фунгицидов.



← 0,50 m →
NOZZLE SPACING 0,50 m - SPRAYING VOLUME (l/ha)

Part No.	Type	Pressure		VMD	l/min	Spraying Volume (l/ha)												
		bar	psi			4 Km/h	5 Km/h	6 Km/h	7 Km/h	8 Km/h	9 Km/h	10 Km/h	12 Km/h	14 Km/h	16 Km/h	18 Km/h	20 Km/h	25 Km/h
8259440	AD 01.D	2	30	M	0,32	96	77	64	55	48	43	38	32	27	24	21	19	15
		3,1	45	F	0,41	123	98	82	70	62	55	49	41	35	31	27	25	20
		4,1	60	F	0,46	138	110	92	79	69	61	55	46	39	35	31	28	22
8259441	AD 015.D	2	30	M	0,50	150	120	100	86	75	67	60	50	43	38	33	30	24
		3,1	45	M	0,61	183	146	122	105	92	81	73	61	52	46	41	37	29
		4,1	60	F	0,70	210	168	140	120	105	93	84	70	60	53	47	42	34
8259442	AD 02.D	2	30	M	0,66	198	158	132	113	99	88	79	66	57	50	44	40	32
		3,1	45	M	0,82	246	197	164	141	123	109	98	82	70	62	55	49	39
		4,1	60	F	0,95	285	228	190	163	143	127	114	95	81	71	63	57	46
8259443	AD 025.D	2	30	M	0,83	249	199	166	142	125	111	100	83	71	62	55	50	40
		3,1	45	M	1,04	312	250	208	178	156	139	125	104	89	78	69	62	50
		4,1	60	F	1,20	360	288	240	206	180	160	144	120	103	90	80	72	58
8259444	AD 03.D	2	30	M	1,00	300	240	200	171	150	133	120	100	86	75	67	60	48
		3,1	45	M	1,25	375	300	250	214	188	167	150	125	107	94	83	75	60
		4,1	60	M	1,43	429	343	286	245	215	191	172	143	123	107	95	86	69
8259445	AD 04.D	2	30	G	1,32	396	317	264	226	198	176	158	132	113	99	88	79	63
		3,1	45	M	1,62	486	389	324	278	243	216	194	162	139	122	108	97	78
		4,1	60	M	1,89	567	454	378	324	284	252	227	189	162	142	126	113	91
8259446	AD 05.D	2	30	G	1,67	501	401	334	286	251	223	200	167	143	125	111	100	80
		3,1	45	M	2,07	621	497	414	355	311	276	248	207	177	155	138	124	99
		4,1	60	M	2,39	717	574	478	410	359	319	287	239	205	179	159	143	115
8259447	AD 06.D	2	30	G	2,02	606	485	404	346	303	269	242	202	173	152	135	121	97
		3,1	45	M	2,49	747	598	498	427	374	332	299	249	213	187	166	149	120
		4,1	60	M	2,86	858	686	572	490	429	381	343	286	245	215	191	172	137
8259448	AD 08.D	2	30	G	2,77	831	665	554	475	416	369	332	277	237	208	185	166	133
		3,1	45	G	3,37	1011	809	674	578	506	449	404	337	289	253	225	202	162
		4,1	60	M	3,86	1158	926	772	662	579	515	463	386	331	290	257	232	185

OPTIONALS



Pag. 293



Pag. 254-255

8253028	red
8253029	yellow
8253030	green
8253031	blue
8253069	orange
8253070	brown
8253071	black
8253126	white
8253127	light blue
8253128	violet

ST-IA



CERAMIC



2÷6,5 bar

SERIE ST-IA "SUPER TURBO" A INDUZIONE D'ARIA - Ugelli per uso a pieno campo a induzione d'aria

Caratteristiche

- Realizzati in ceramica, con un contenuto di Allumina del 99%;
- Dotati di un grande angolo di apertura (140°), che permette di lavorare con la barra del nebulizzatore più vicina al punto da irrorare;
- Ventaglio con un'inclinazione di 30° che consente una migliore penetrazione nel punto da irrorare (o in colture con grande massa fogliare);
- Foro di uscita più ampio che ne facilita la pulizia e ne evita l'intasamento;
- Permette di lavorare con venti che raggiungono i 20 km/h;
- Pressione consigliata da 2 a 6.5 bar;
- Dispone di un sistema Venturi a induzione d'aria nelle gocce, che consente a queste ultime di raggiungere grandi dimensioni, anche a pressioni elevate.

ST-IA SERIES AIR INDUCTION "SUPER TURBO"
Air induction nozzles for full-field use

Features

- Made in ceramic with a 99% alumina content;
- These nozzles have a wide opening angle (140°) which means the mist blower boom can be used closer to the point to spray;
- 30° fan angle ensuring better penetration in the point to spray (or on crops with a mass of leaves);
- A bigger outlet hole for easier cleaning and no clogging.
- It can be used even with 20 km/h winds
- Pressure recommended ranges from 2 to 6.5 bar
- It has a Venturi air induction system for the drops so they can become very big even at high pressures.

СЕРИЯ ST-IA « SUPER TURBO » С ПОДАЧЕЙ ВОЗДУХА - Форсунки для полевых опрыскивателей с подачей воздуха

Характеристики

- Из керамики с содержанием алюминия 99%.
- Характеризуются большим углом открытия (140°), что позволяет работать с ближней к точке орошения точке штангой.
- Струя с наклоном 30°, что обеспечивает лучшее проникновение в точку орошения (или в растение со значительной массой листьев).
- Больше выходное отверстие упрощает очистку и предупреждает засорение.
- Позволяет работать при ветре до 20 км/ч.
- Рекомендуемое давление от 2 до 6,5 бар.
- Располагает системой Вентури с подачей воздуха в капли, что позволяет последним достигать больших размеров, даже при высоком давлении.

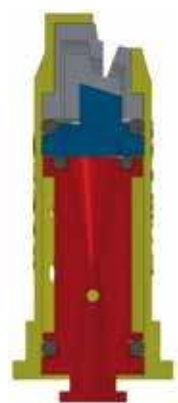

← 0,50 m →
NOZZLE SPACING 0,50 m - SPRAYING VOLUME (l/ha)

Part No.	Type	bar		VMD	l/min	Kmh/h												
		2	3,4			4	5	6	7	8	9	10	12	14	16	18	20	25
8259404	ST-IA 01	2	30	EG	0,38	114	91	76	65	57	51	46	38	33	29	25	23	18
		3,4	50	EG	0,43	129	103	86	74	65	57	52	43	37	32	29	26	21
		4,8	70	MG	0,50	150	120	100	86	75	67	60	50	43	38	33	30	24
		6,2	90	MG	0,56	168	134	112	96	84	75	67	56	48	42	37	34	27
8259405	ST-IA 015	2	30	EG	0,48	144	115	96	82	72	64	58	48	41	36	32	29	23
		3,4	50	EG	0,65	195	156	130	111	98	87	78	65	56	49	43	39	31
		4,8	70	MG	0,77	231	185	154	132	116	103	92	77	66	58	51	46	37
		6,2	90	MG	0,86	258	206	172	147	129	115	103	86	74	65	57	52	41
8259406	ST-IA 02	2	30	EG	0,67	201	161	134	115	101	89	80	67	57	50	45	40	32
		3,4	50	EG	0,89	267	214	178	153	134	119	107	89	76	67	59	53	43
		4,8	70	EG	1,04	312	250	208	178	156	139	125	104	89	78	69	62	50
		6,2	90	EG	1,18	354	283	236	202	177	157	142	118	101	89	79	71	57
8259407	ST-IA 025	2	30	EG	0,83	249	199	166	142	125	111	100	83	71	62	55	50	40
		3,4	50	EG	1,09	327	262	218	187	164	145	131	109	93	82	73	65	52
		4,8	70	EG	1,29	387	310	258	221	194	172	155	129	111	97	86	77	62
		6,2	90	EG	1,46	438	350	292	250	219	195	175	146	125	110	97	88	70
8259408	ST-IA 03	2	30	EG	1,01	303	242	202	173	152	135	121	101	87	76	67	61	48
		3,4	50	EG	1,33	399	319	266	228	200	177	160	133	114	100	89	80	64
		4,8	70	EG	1,58	474	379	316	271	237	211	190	158	135	119	105	95	76
		6,2	90	EG	1,80	540	432	360	309	270	240	216	180	154	135	120	108	86
8259409	ST-IA 04	2	30	EG	1,33	399	319	266	228	200	177	160	133	114	100	89	80	64
		3,4	50	EG	1,73	519	415	346	297	260	231	208	173	148	130	115	104	83
		4,8	70	EG	2,06	618	494	412	353	309	275	247	206	177	155	137	124	99
		6,2	90	EG	2,32	696	557	464	398	348	309	278	232	199	174	155	139	111

OPTIONALS



Pag. 293

Pag. 254-255

8253028	red
8253029	yellow
8253030	green
8253031	blue
8253069	orange
8253070	brown
8253071	black
8253126	white
8253127	light blue
8253128	violet

ST



135°



CERAMIC



SERIE ST "SUPER TURBO" - Ugelli per uso a pieno campo senza induzione d'aria

Caratteristiche

- Realizzati in ceramica, con un contenuto di Allumina del 99%;
- Dotati di un grande angolo di apertura (max 135°), che permette di lavorare con la barra del nebulizzatore più vicina al punto da irrorare;
- Ventaglio con un'inclinazione di 30° in avanti, che fornisce una migliore penetrazione nel punto da irrorare (o in colture con grande massa fogliare);
- Foro di uscita più ampio che ne facilita la pulizia e ne evita l'intasamento;
- Consente una buona copertura del punto da irrorare;
- Pressione consigliata 1,5 a 6 bar.

ST SERIES "SUPER TURBO" - Nozzles for full-field use without air induction

Features

- Made in ceramic with a 99% alumina content;
- These nozzles have a wide opening angle (max 135°) which means the mist blower boom can be used closer to the point to spray;
- 30° forward fan angle ensuring better penetration in the point to spray (or on crops with a mass of leaves);
- A bigger outlet hole for easier cleaning and no clogging;
- It provides good coverage of the point sprayed;
- Pressure recommended ranges from 1,5 to 6 bar.

СЕРИЯ ST « SUPER TURBO » - Форсунки для полевых опрыскивателей без подачи воздуха

Характеристики

- Из керамики с содержанием алюминия 99%.
- Характеризуются большим углом открытия (макс. 135°), что позволяет работать с ближайшей к точке орошения штанге.
- Струя с наклоном 30° вперед, обеспечивающая лучшее проникновение в точку орошения (или в растения с большой массой листьев).
- Большое выходное отверстие упрощает очистку и предупреждает засорение.
- Обеспечивает хорошее покрытие.
- Рекомендуемое давление от 1,5 до 6 бар.

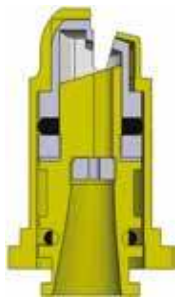

NOZZLE SPACING 0,50 m - SPRAYING VOLUME (l/ha)

Part No.	Type	bar	psi	VMD	l/min	NOZZLE SPACING 0,50 m - SPRAYING VOLUME (l/ha)													
						4 Km/h	5 Km/h	6 Km/h	7 Km/h	8 Km/h	9 Km/h	10 Km/h	12 Km/h	14 Km/h	16 Km/h	18 Km/h	20 Km/h	25 Km/h	
8259449	ST 01	1.4	20	G	0.25	75	60	50	43	38	33	30	25	21	19	17	15	12	
		2	30	G	0.32	96	77	64	55	48	43	38	32	27	24	21	19	15	15
		3.1	45	M	0.41	123	98	82	70	62	55	49	41	35	31	27	25	20	20
		4.1	60	M	0.46	138	110	92	79	69	61	55	46	39	35	31	28	22	22
		5	75	M	0.53	159	127	106	91	80	71	64	53	45	40	35	32	25	25
		6.2	90	M	0.58	174	139	116	99	87	77	70	58	50	44	39	35	28	28
8259450	ST 015	1.4	20	G	0.40	120	96	80	69	60	53	48	40	34	30	27	24	19	
		2	30	G	0.50	150	120	100	86	75	67	60	50	43	38	33	30	24	
		3.1	45	G	0.61	183	146	122	105	92	81	73	61	52	46	41	37	29	
		4.1	60	M	0.70	210	168	140	120	105	93	84	70	60	53	47	42	34	
		5	75	M	0.80	240	192	160	137	120	107	96	80	69	60	53	48	38	
		6.2	90	M	0.87	261	209	174	149	131	116	104	87	75	65	58	52	42	
8259451	ST 02	1.4	20	MG	0.56	168	134	112	96	84	75	67	56	48	42	37	34	27	
		2	30	MG	0.66	198	158	132	113	99	88	79	66	57	50	44	40	32	
		3.1	45	G	0.82	246	197	164	141	123	109	98	82	70	62	55	49	39	
		4.1	60	G	0.95	285	228	190	163	143	127	114	95	81	71	63	57	46	
		5	75	M	1.05	315	252	210	180	158	140	126	105	90	79	70	63	50	
		6.2	90	M	1.14	342	274	228	195	171	152	137	114	98	86	76	68	55	
8259452	ST 025	1.4	20	MG	0.70	210	168	140	120	105	93	84	70	60	53	47	42	34	
		2	30	MG	0.83	249	199	166	142	125	111	100	83	71	62	55	50	40	
		3.1	45	G	1.04	312	250	208	178	156	139	125	104	89	78	69	62	50	
		4.1	60	G	1.20	360	288	240	206	180	160	144	120	103	90	80	72	58	
		5	75	G	1.31	393	314	262	225	197	175	157	131	112	98	87	79	63	
		6.2	90	M	1.43	429	343	286	245	215	191	172	143	123	107	95	86	69	
8259453	ST 03	1.4	20	MG	0.82	246	197	164	141	123	109	98	82	70	62	55	49	39	
		2	30	MG	1.00	300	240	200	171	150	133	120	100	86	75	67	60	48	
		3.1	45	G	1.25	375	300	250	214	188	167	150	125	107	94	83	75	60	
		4.1	60	G	1.43	429	343	286	245	215	191	172	143	123	107	95	86	69	
		5	75	G	1.55	465	372	310	266	233	207	186	155	133	116	103	93	74	
		6.2	90	M	1.70	510	408	340	291	255	227	204	170	146	128	113	102	82	
8259454	ST 04	1.4	20	MG	1.10	330	264	220	189	165	147	132	110	94	83	73	66	53	
		2	30	MG	1.32	396	317	264	226	198	176	158	132	113	99	88	79	63	
		3.1	45	G	1.62	486	389	324	278	243	216	194	162	139	122	108	97	78	
		4.1	60	G	1.89	567	454	378	324	284	252	227	189	162	142	126	113	91	
		5	75	G	2.07	621	497	414	355	311	276	248	207	177	155	138	124	99	
		6.2	90	G	2.27	681	545	454	389	341	303	272	227	195	170	151	136	109	
8259455	ST 05	1.4	20	MG	1.38	414	331	276	237	207	184	166	138	118	104	92	83	66	
		2	30	MG	1.67	501	401	334	286	251	223	200	167	143	125	111	100	80	
		3.1	45	G	2.07	621	497	414	355	311	276	248	207	177	155	138	124	99	
		4.1	60	G	2.39	717	574	478	410	359	319	287	239	205	179	159	143	115	
		5	75	G	2.58	774	619	516	442	387	344	310	258	221	194	172	155	124	
		6.2	90	G	2.83	849	679	566	485	425	377	340	283	243	212	189	170	136	
8259456	ST 06	1.4	20	MG	1.67	501	401	334	286	251	223	200	167	143	125	111	100	80	
		2	30	MG	2.02	606	485	404	346	303	269	242	202	173	152	135	121	97	
		3.1	45	G	2.49	747	598	498	427	374	332	299	249	213	187	166	149	120	
		4.1	60	G	2.86	858	686	572	490	429	381	343	286	245	215	191	172	137	
		5	75	G	3.10	930	744	620	531	465	413	372	310	266	233	207	186	149	
		6.2	90	G	3.39	1017	814	678	581	509	452	407	339	291	254	226	203	163	

OPTIONALS



Pag. 293



Pag. 254-255

8253028	red
8253029	yellow
8253030	green
8253031	blue
8253069	orange
8253070	brown
8253071	black
8253126	white
8253127	light blue
8253128	violet

MGA



CERAMIC



4,8=20,7 bar

SERIE MGA - Ugelli per uso a pieno campo senza induzione d'aria

Caratteristiche

- Realizzati in ceramica, con un contenuto di Allumina del 99%;
- Pressione consigliata 4,8 a 20,7 bar.
- Angolo di 90°;
- Riduce le gocce rendendole estremamente fini e formando una copertura molto uniforme;
- Consente una migliore copertura della superficie fogliare e una migliore penetrazione;
- Indicato per l'applicazione di fungicidi e insetticidi sistemici;

MGA SERIES - Nozzles for full-field use without air induction

Features

- Made in ceramic with a 99% alumina content;
- Pressure recommended ranges from 4.8 to 20.7 bar.
- 80° angle;
- Reduces the drops so they are extremely fine to give a really uniform coverage;
- It gives a better coverage of leaf surface and better penetration;
- Suitable for spraying systemic fungicides and insecticides;

СЕРИЯ MGA - Форсунки для полевых опрыскивателей без подачи воздуха

Характеристики

- Из керамики с содержанием алюминия 99%.
- Рекомендуемое давление от 4,8 до 20,7 бар.
- Угол 80°.
- Уменьшает капли, делая их крайне тонкими, и образует равномерное покрытие
- Обеспечивает лучшее покрытие поверхности листьев и проникновение.
- Предусмотрена для применения с фунгицидами и инсектицидами.

90°

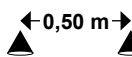

NOZZLE SPACING 0,50 m - SPRAYING VOLUME (l/ha)

Part No.	Type	bar		VMD	l/min	Kmh/h												
		psi	MF			4	5	6	7	8	9	10	12	14	16	18	20	25
8259484	MGA 900067	4,8	70	MF	0,33	99	79	66	57	50	44	40	33	28	25	22	20	16
		6,9	100	MF	0,39	117	94	78	67	59	52	47	39	33	29	26	23	19
		10,4	150	MF	0,46	138	110	92	79	69	61	55	46	39	35	31	28	22
		13,8	200	MF	0,56	168	134	112	96	84	75	67	56	48	42	37	34	27
8259485	MGA 9001	4,8	70	MF	0,50	150	120	100	86	75	67	60	50	43	38	33	30	24
		6,9	100	MF	0,59	177	142	118	101	89	79	71	59	51	44	39	35	28
		10,4	150	MF	0,68	204	163	136	117	102	91	82	68	58	51	45	41	33
		13,8	200	MF	0,82	246	197	164	141	123	109	98	82	70	62	55	49	39
8259486	MGA 90015	4,8	70	MF	0,75	225	180	150	129	113	100	90	75	64	56	50	45	36
		6,9	100	MF	0,90	270	216	180	154	135	120	108	90	77	68	60	54	43
		10,4	150	MF	1,05	315	252	210	180	158	140	126	105	90	79	70	63	50
		13,8	200	MF	1,25	375	300	250	214	188	167	150	125	107	94	83	75	60
8259487	MGA 9002	4,8	70	MF	1,00	300	240	200	171	150	133	120	100	86	75	67	60	48
		6,9	100	MF	1,20	360	288	240	206	180	160	144	120	103	90	80	72	58
		10,4	150	MF	1,42	426	341	284	243	213	189	170	142	122	107	95	85	68
		13,8	200	MF	1,65	495	396	330	283	248	220	198	165	141	124	110	99	79
8259488	MGA 90025	4,8	70	MF	1,25	375	300	250	214	188	167	150	125	107	94	83	75	60
		6,9	100	MF	1,50	450	360	300	257	225	200	180	150	129	113	100	90	72
		10,4	150	MF	1,81	543	434	362	310	272	241	217	181	155	136	121	109	87
		13,8	200	MF	2,07	621	497	414	355	311	276	248	207	177	155	138	124	99
8259489	MGA 9003	4,8	70	MF	1,50	450	360	300	257	225	200	180	150	129	113	100	90	72
		6,9	100	MF	1,80	540	432	360	309	270	240	216	180	154	135	120	108	86
		10,4	150	MF	2,20	660	528	440	377	330	293	264	220	189	165	147	132	106
		13,8	200	MF	2,50	750	600	500	429	375	333	300	250	214	188	167	150	120
8259490	MGA 9004	4,8	70	F	2,10	630	504	420	360	315	280	252	210	180	158	140	126	101
		6,9	100	MF	2,55	765	612	510	437	383	340	306	255	219	191	170	153	122
		10,4	150	MF	3,10	930	744	620	531	465	413	372	310	266	233	207	186	149
		13,8	200	MF	3,50	1050	840	700	600	525	467	420	350	300	263	233	210	168

OPTIONALS



Pag. 293

Pag. 254-255

8253093	red
8253094	yellow
8253095	green
8253096	violet
8253097	orange
8253098	gray
8253099	black

MGA



CERAMIC



2,7÷20,7 bar

SERIE MGA - Ugelli per uso a pieno campo senza induzione d'aria

MGA SERIES - Nozzles for full-field use without air induction

СЕРИЯ MGA - Форсунки для полевых опрыскивателей без подачи воздуха

Caratteristiche

- Realizzati in ceramica, con un contenuto di Allumina del 99%;
- Pressione consigliata 2,7 a 20,7 bar.
- Angolo di 60°;
- Riduce le gocce rendendole estremamente fini e formando una copertura molto uniforme;
- Consente una migliore copertura della superficie fogliare e una migliore penetrazione;
- Indicato per l'applicazione di fungicidi e insetticidi sistemici;

Features

- Made in ceramic with a 99% alumina content;
- Pressure recommended ranges from 2.7 to 20.7 bar.
- 60° angle;
- Reduces the drops so they are extremely fine to give a really uniform coverage;
- It gives a better coverage of leaf surface and better penetration;
- Suitable for spraying systemic fungicides and insecticides;

Характеристики

- Из керамики с содержанием алюминия 99%.
- Рекомендуемое давление от 2,7 до 20,7 бар.
- Угол 60°.
- Уменьшает капли, делая их крайне тонкими, и образует равномерное покрытие
- Обеспечивает лучшее покрытие поверхности листьев и проникновение.
- Предусмотрена для применения с фунгицидами и инсектицидами.



← 0,50 m →
NOZZLE SPACING 0,50 m - SPRAYING VOLUME (l/ha)

Part No.	Type	bar	psi	VMD	l/min	NOZZLE SPACING 0,50 m - SPRAYING VOLUME (l/ha)												
						4 Km/h	5 Km/h	6 Km/h	7 Km/h	8 Km/h	9 Km/h	10 Km/h	12 Km/h	14 Km/h	16 Km/h	18 Km/h	20 Km/h	25 Km/h
8259579	MGA 60-01	2,7	40	MF	0,39	117	94	78	67	59	52	47	39	33	29	26	23	19
		3,8	55	MF	0,45	135	108	90	77	68	60	54	45	39	34	30	27	22
		4,8	70	MF	0,50	150	120	100	86	75	67	60	50	43	38	33	30	24
		6,9	100	MF	0,59	177	142	118	101	89	79	71	59	51	44	39	35	28
		10,4	150	MF	0,68	204	163	136	117	102	91	82	68	58	51	45	41	33
		13,8	200	MF	0,82	246	197	164	141	123	109	98	82	70	62	55	49	39
8259582	MGA 60-015	2,7	40	MF	0,57	171	137	114	98	86	76	68	57	49	43	38	34	27
		3,8	55	MF	0,67	201	161	134	115	101	89	80	67	57	50	45	40	32
		4,8	70	MF	0,75	225	180	150	129	113	100	90	75	64	56	50	45	36
		6,9	100	MF	0,90	270	216	180	154	135	120	108	90	77	68	60	54	43
		10,4	150	MF	1,05	315	252	210	180	158	140	126	105	90	79	70	63	50
		13,8	200	MF	1,25	375	300	250	214	188	167	150	125	107	94	83	75	60
8259583	MGA 60-02	2,7	40	F	0,75	225	180	150	129	113	100	90	75	64	56	50	45	36
		3,8	55	MF	0,87	261	209	174	149	131	116	104	87	75	65	58	52	42
		4,8	70	MF	1,00	300	240	200	171	150	133	120	100	86	75	67	60	48
		6,9	100	MF	1,20	360	288	240	206	180	160	144	120	103	90	80	72	58
		10,4	150	MF	1,42	426	341	284	243	213	189	170	142	122	107	95	85	68
		13,8	200	MF	1,65	495	396	330	283	248	220	198	165	141	124	110	99	79
8259584	MGA 60-025	2,7	40	F	0,95	285	228	190	163	143	127	114	95	81	71	63	57	46
		3,8	55	MF	1,10	330	264	220	189	165	147	132	110	94	83	73	66	53
		4,8	70	MF	1,25	375	300	250	214	188	167	150	125	107	94	83	75	60
		6,9	100	MF	1,50	450	360	300	257	225	200	180	150	129	113	100	90	72
		10,4	150	MF	1,81	543	434	362	310	272	241	217	181	155	136	121	109	87
		13,8	200	MF	2,07	621	497	414	355	311	276	248	207	177	155	138	124	99
8259585	MGA 60-03	2,7	40	F	1,15	345	276	230	197	173	153	138	115	99	86	77	69	55
		3,8	55	F	1,33	399	319	266	228	200	177	160	133	114	100	89	80	64
		4,8	70	MF	1,50	450	360	300	257	225	200	180	150	129	113	100	90	72
		6,9	100	MF	1,80	540	432	360	309	270	240	216	180	154	135	120	108	86
		10,4	150	MF	2,20	660	528	440	377	330	293	264	220	189	165	147	132	106
		13,8	200	MF	2,50	750	600	500	429	375	333	300	250	214	188	167	150	120
8259586	MGA 60-035	2,7	40	F	0,95	285	228	190	163	143	127	114	95	81	71	63	57	46
		3,8	55	F	1,10	330	264	220	189	165	147	132	110	94	83	73	66	53
		4,8	70	MF	1,25	375	300	250	214	188	167	150	125	107	94	83	75	60
		6,9	100	MF	1,50	450	360	300	257	225	200	180	150	129	113	100	90	72
		10,4	150	MF	1,81	543	434	362	310	272	241	217	181	155	136	121	109	87
		13,8	200	MF	2,07	621	497	414	355	311	276	248	207	177	155	138	124	99
8259587	MGA 60-04	2,7	40	F	1,61	483	386	322	276	242	215	193	161	138	121	107	97	77
		3,8	55	F	1,88	564	451	376	322	282	251	226	188	161	141	125	113	90
		4,8	70	F	2,10	630	504	420	360	315	280	252	210	180	158	140	126	101
		6,9	100	MF	2,55	765	612	510	437	383	340	306	255	219	191	170	153	122
		10,4	150	MF	3,10	930	744	620	531	465	413	372	310	266	233	207	186	149
		13,8	200	MF	3,50	1050	840	700	600	525	467	420	350	300	263	233	210	168
8259588	MGA 60-05	2,7	40	F	1,96	588	470	392	336	294	261	235	196	168	147	131	118	94
		3,8	55	F	2,38	714	571	476	408	357	317	286	238	204	179	159	143	114
		4,8	70	F	2,55	765	612	510	437	383	340	306	255	219	191	170	153	122
		6,9	100	F	3,00	900	720	600	514	450	400	360	300	257	225	200	180	144
		10,4	150	MF	3,70	1110	888	740	634	555	493	444	370	317	278	247	222	178
		13,8	200	MF	4,28	1284	1027	856	734	642	571	514	428	367	321	285	257	205
8259589	MGA 60-06	2,7	40	F	2,34	702	562	468	401	351	312	281	234	201	176	156	140	112
		3,8	55	F	2,75	825	660	550	471	413	367	330	275	236	206	183	165	132
		4,8	70	F	2,95	885	708	590	506	443	393	354	295	253	221	197	177	142
		6,9	100	F	3,65	1095	876	730	626	548	487	438	365	313	274	243	219	175
		10,4	150	MF	4,42	1326	1061	884	758	663	589	530	442	379	332	295	265	212
		13,8	200	MF	5,15	1545	1236	1030	883	773	687	618	515	441	386	343	309	247
20,7	300	MF	6,25	1875	1500	1250	1071	938	833	750	625	536	469	417	375	300		

OPTIONALS



Pag. 293

Pag. 254-255

8253093	red
8253094	yellow
8253095	green
8253096	violet
8253097	orange
8253098	gray
8253099	black

MGA



CERAMIC



2,7÷20,7 bar

SERIE MGA - Ugelli per uso a pieno campo senza induzione d'aria

Caratteristiche

- Realizzati in ceramica, con un contenuto di Allumina del 99%;
- Pressione consigliata 2,7 a 20,7 bar.
- Angolo di 40°;
- Riduce le gocce rendendole estremamente fini e formando una copertura molto uniforme;
- Consente una migliore copertura della superficie fogliare e una migliore penetrazione;
- Indicato per l'applicazione di fungicidi e insetticidi sistemici;

MGA SERIES - Nozzles for full-field use without air induction

Features

- Made in ceramic with a 99% alumina content;
- Pressure recommended ranges from 2.7 to 20.7 bar;
- 40° angle;
- Reduces the drops so they are extremely fine to give a really uniform coverage;
- It gives a better coverage of leaf surface and better penetration;
- Suitable for spraying systemic fungicides and insecticides;

СЕРИЯ MGA - Форсунки для полевых опрыскивателей без подачи воздуха

Характеристики

- Из керамики с содержанием алюминия 99%;
- Рекомендуемое давление от 2,7 до 20,7 бар.
- Угол 40°;
- Уменьшает капли, делая их крайне тонкими, и образует равномерное покрытие;
- Обеспечивает лучшее покрытие поверхности листьев и проникновение;
- Предусмотрена для применения с фунгицидами и инсектицидами.



40°

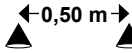

NOZZLE SPACING 0,50 m - SPRAYING VOLUME (l/ha)

Part No.	Type	bar	psi	VMD l/min	NOZZLE SPACING 0,50 m - SPRAYING VOLUME (l/ha)													
					4 Km/h	5 Km/h	6 Km/h	7 Km/h	8 Km/h	9 Km/h	10 Km/h	12 Km/h	14 Km/h	16 Km/h	18 Km/h	20 Km/h	25 Km/h	
8259590	MGA 40-01	2,7	40	MF	0,39	117	94	78	67	59	52	47	39	33	29	26	23	19
		3,8	55	MF	0,45	135	108	90	77	68	60	54	45	39	34	30	27	22
		4,8	70	MF	0,50	150	120	100	86	75	67	60	50	43	38	33	30	24
		6,9	100	MF	0,59	177	142	118	101	89	79	71	59	51	44	39	35	28
		10,4	150	MF	0,68	204	163	136	117	102	91	82	68	58	51	45	41	33
		13,8	200	MF	0,82	246	197	164	141	123	109	98	82	70	62	55	49	39
8259591	MGA 40-015	2,7	40	MF	0,57	171	137	114	98	86	76	68	57	49	43	38	34	27
		3,8	55	MF	0,67	201	161	134	115	101	89	80	67	57	50	45	40	32
		4,8	70	MF	0,75	225	180	150	129	113	100	90	75	64	56	50	45	36
		6,9	100	MF	0,90	270	216	180	154	135	120	108	90	77	68	60	54	43
		10,4	150	MF	1,05	315	252	210	180	158	140	126	105	90	79	70	63	50
		13,8	200	MF	1,25	375	300	250	214	188	167	150	125	107	94	83	75	60
8259592	MGA 40-02	2,7	40	F	0,75	225	180	150	129	113	100	90	75	64	56	50	45	36
		3,8	55	MF	0,87	261	209	174	149	131	116	104	87	75	65	58	52	42
		4,8	70	MF	1,00	300	240	200	171	150	133	120	100	86	75	67	60	48
		6,9	100	MF	1,20	360	288	240	206	180	160	144	120	103	90	80	72	58
		10,4	150	MF	1,42	426	341	284	243	213	189	170	142	122	107	95	85	68
		13,8	200	MF	1,65	495	396	330	283	248	220	198	165	141	124	110	99	79
8259593	MGA 40-025	2,7	40	F	0,95	285	228	190	163	143	127	114	95	81	71	63	57	46
		3,8	55	MF	1,10	330	264	220	189	165	147	132	110	94	83	73	66	53
		4,8	70	MF	1,25	375	300	250	214	188	167	150	125	107	94	83	75	60
		6,9	100	MF	1,50	450	360	300	257	225	200	180	150	129	113	100	90	72
		10,4	150	MF	1,81	543	434	362	310	272	241	217	181	155	136	121	109	87
		13,8	200	MF	2,07	621	497	414	355	311	276	248	207	177	155	138	124	99
8259594	MGA 40-03	2,7	40	F	1,15	345	276	230	197	173	153	138	115	99	86	77	69	55
		3,8	55	F	1,33	399	319	266	228	200	177	160	133	114	100	89	80	64
		4,8	70	MF	1,50	450	360	300	257	225	200	180	150	129	113	100	90	72
		6,9	100	MF	1,80	540	432	360	309	270	240	216	180	154	135	120	108	86
		10,4	150	MF	2,20	660	528	440	377	330	293	264	220	189	165	147	132	106
		13,8	200	MF	2,50	750	600	500	429	375	333	300	250	214	188	167	150	120
8259595	MGA 40-035	2,7	40	F	0,95	285	228	190	163	143	127	114	95	81	71	63	57	46
		3,8	55	F	1,10	330	264	220	189	165	147	132	110	94	83	73	66	53
		4,8	70	MF	1,25	375	300	250	214	188	167	150	125	107	94	83	75	60
		6,9	100	MF	1,50	450	360	300	257	225	200	180	150	129	113	100	90	72
		10,4	150	MF	1,81	543	434	362	310	272	241	217	181	155	136	121	109	87
		13,8	200	MF	2,07	621	497	414	355	311	276	248	207	177	155	138	124	99
8259596	MGA 40-04	2,7	40	F	1,61	483	386	322	276	242	215	193	161	138	121	107	97	77
		3,8	55	F	1,88	564	451	376	322	282	251	226	188	161	141	125	113	90
		4,8	70	F	2,10	630	504	420	360	315	280	252	210	180	158	140	126	101
		6,9	100	MF	2,55	765	612	510	437	383	340	306	255	219	191	170	153	122
		10,4	150	MF	3,10	930	744	620	531	465	413	372	310	266	233	207	186	149
		13,8	200	MF	3,50	1050	840	700	600	525	467	420	350	300	263	233	210	168
8259597	MGA 40-05	2,7	40	F	1,96	588	470	392	336	294	261	235	196	168	147	131	118	94
		3,8	55	F	2,38	714	571	476	408	357	317	286	238	204	179	159	143	114
		4,8	70	F	2,55	765	612	510	437	383	340	306	255	219	191	170	153	122
		6,9	100	F	3,00	900	720	600	514	450	400	360	300	257	225	200	180	144
		10,4	150	MF	3,70	1110	888	740	634	555	493	444	370	317	278	247	222	178
		13,8	200	MF	4,28	1284	1027	856	734	642	571	514	428	367	321	285	257	205

OPTIONALS



Pag. 293

Pag. 254-255

8253093	red
8253094	yellow
8253095	green
8253096	violet
8253097	orange
8253098	gray
8253099	black

MAG-CH



CERAMIC



3,5÷10 bar

SERIE MAG-CH CONO PIENO - Ugelli per uso a pieno campo senza induzione d'aria

Caratteristiche

- Realizzati in ceramica, con un contenuto di Allumina del 99%;
- Cono pieno con angolo di 80°;
- Pressione consigliata da 3,5 a 10 bar;
- Produce gocce da fini a molto fini, in base alla pressione di lavoro;
- Consente una copertura e una penetrazione eccellenti nel punto da irrorare;
- È necessario prestare molta attenzione nel caso si utilizzi questa serie di ugelli in aree ventose, dal momento che la grandezza delle gocce favorisce la deriva.

MAG-CH SERIES SOLID CONE - Nozzles for full-field use without air induction

Features

- Made in ceramic with a 99% alumina content;
- Solid cone with an 80° angle;
- Pressure recommended ranges from 3,5 to 10 bar;
- Produces fine to very fine drops depending on the working pressure;
- Provides excellent coverage and penetration of the point sprayed;
- Maximum attention must be given when using this series of nozzles in windy areas since the size of the drops does favour drift.

СЕРИЯ MAG-CH С ПОЛНЫМ КОНУСОМ - Форсунки для полевых опрыскивателей без подачи воздуха

Характеристики

- Из керамики с содержанием алюминия 99%.
- Полный конус с углом 80°.
- Рекомендуемое давление от 3,5 до 10 бар.
- Производит очень тонкие или тонкие капли, в зависимости от рабочего давления.
- Обеспечивает превосходное покрытие и проникновение в точку орошения.
- Необходимо уделять большое внимание в случае использования этой серии форсунок в зонах с ветром, в связи с тем, что размер капель содействует их сносу ветром.



← 0,50 m →
NOZZLE SPACING 0,50 m - SPRAYING VOLUME (l/ha)

Part No.	Type	bar	psi	VMD	NOZZLE SPACING 0,50 m - SPRAYING VOLUME (l/ha)													
					l/min	4 Km/h	5 Km/h	6 Km/h	7 Km/h	8 Km/h	9 Km/h	10 Km/h	12 Km/h	14 Km/h	16 Km/h	18 Km/h	20 Km/h	25 Km/h
8259376	MAG-CH 0,5	3,4	50	F	0,56	168	134	112	96	84	75	67	56	48	42	37	34	27
		4,8	70	F	0,66	198	158	132	113	99	88	79	66	57	50	44	40	32
		6,2	90	F	0,74	222	178	148	127	111	99	89	74	63	56	49	44	36
		7,6	110	MF	0,82	246	197	164	141	123	109	98	82	70	62	55	49	39
		9	130	MF	0,84	252	202	168	144	126	112	101	84	72	63	56	50	40
8259377	MAG-CH 0,75	3,4	50	F	0,75	225	180	150	129	113	100	90	75	64	56	50	45	36
		4,8	70	F	0,90	270	216	180	154	135	120	108	90	77	68	60	54	43
		6,2	90	F	1,00	300	240	200	171	150	133	120	100	86	75	67	60	48
		7,6	110	F	1,10	330	264	220	189	165	147	132	110	94	83	73	66	53
		9	130	MF	1,20	360	288	240	206	180	160	144	120	103	90	80	72	58
8259378	MAG-CH 1	3,4	50	F	1,00	300	240	200	171	150	133	120	100	86	75	67	60	48
		4,8	70	F	1,20	360	288	240	206	180	160	144	120	103	90	80	72	58
		6,2	90	F	1,33	390	319	266	228	200	177	160	133	114	100	89	80	64
		7,6	110	F	1,47	441	353	294	252	221	196	176	147	126	110	98	88	71
		9	130	MF	1,63	489	391	326	279	245	217	196	163	140	122	109	98	78
8259379	MAG-CH 2	3,4	50	F	1,28	384	307	256	219	192	171	154	128	110	96	85	77	61
		4,8	70	F	1,52	456	365	304	261	228	203	182	152	130	114	101	91	73
		6,2	90	F	1,72	516	413	344	295	258	229	206	172	147	129	115	103	83
		7,6	110	F	1,90	570	456	380	326	285	253	228	190	163	143	127	114	91
		9	130	F	2,05	615	492	410	351	308	273	246	205	176	154	137	123	98
8259380	MAG-CH 3	3,4	50	F	1,50	450	360	300	257	225	200	180	150	129	113	100	90	72
		4,8	70	F	1,75	525	420	350	300	263	233	210	175	150	131	117	105	84
		6,2	90	F	2,00	600	480	400	343	300	267	240	200	171	150	133	120	96
		7,6	110	F	2,20	660	528	440	377	330	293	264	220	189	165	147	132	106
		9	130	F	2,40	720	576	480	411	360	320	288	240	206	180	160	144	115
8259381	MAG-CH 4	3,4	50	M	1,94	582	466	388	333	291	259	233	194	166	146	129	116	93
		4,8	70	F	2,25	675	540	450	386	338	300	270	225	193	169	150	135	108
		6,2	90	F	2,53	759	607	506	434	380	337	304	253	217	190	169	152	121
		7,6	110	F	2,82	846	677	564	483	423	376	338	282	242	212	188	169	135
		9	130	F	3,00	900	720	600	514	450	400	360	300	257	225	200	180	144
8259382	MAG-CH 5	3,4	50	M	2,13	639	511	426	365	320	284	256	213	183	160	142	128	102
		4,8	70	F	2,55	765	612	510	437	383	340	306	255	219	191	170	153	122
		6,2	90	F	2,96	888	710	592	507	444	395	355	296	254	222	197	178	142
		7,6	110	F	3,28	984	787	656	562	492	437	394	328	281	246	219	197	157
		9	130	F	3,50	1050	840	700	600	525	467	420	350	300	263	233	210	168
8259383	MAG-CH 6	3,4	50	M	2,40	720	576	480	411	360	320	288	240	206	180	160	144	115
		4,8	70	F	2,85	855	684	570	489	428	380	342	285	244	214	190	171	137
		6,2	90	F	3,20	960	768	640	549	480	427	384	320	274	240	213	192	154
		7,6	110	F	3,55	1065	852	710	609	533	473	426	355	304	266	237	213	170
		9	130	F	3,86	1158	926	772	662	579	515	463	386	331	290	257	232	185
10,4	150	F	4,08	1224	979	816	699	612	544	490	408	350	306	272	245	196		

OPTIONALS



Pag. 293



Pag. 254-255

8253086	red
8253087	yellow
8253088	green
8253089	blue
8253090	orange
8253091	brown
8253092	black

CV-IA



CERAMIC



SERIE CV-IA CONO VUOTO A INDUZIONE D'ARIA

Ugelli per uso a pieno campo a induzione d'aria

Caratteristiche

- Realizzati in ceramica, con un contenuto di Allumina del 99%;
- Pressione di lavoro da 3 a 10 bar;
- Indicato per l'applicazione di fungicidi e insetticidi sistemici;
- Angolo di apertura di 100°;
- Permette di lavorare con venti fino a 15 km/h.

CV-IA SERIES AIR INDUCTION EMPTY CONE

Air induction nozzles for full-field use

Features

- Made in ceramic with a 99% alumina content;
- Working pressure ranges from 3 to 10 bar;
- Suitable for spraying systemic fungicides and insecticides;
- 100° opening angle;
- It can be used with winds up to 15 km/h.

СЕРИЯ CV-IA С ПУСТЫМ КОНУСОМ ПОДАЧЕЙ ВОЗДУХА

Форсунки для полевых опрыскивателей с подачей воздуха

Характеристики

- Из керамики с содержанием алюминия 99%.
- Рабочее давление от 3 до 10 бар.
- Предназначена для использования с фунгицидами и инсектицидами.
- Угол открытия 100°.
- Позволяет работать при ветре до 15 км/ч.



← 0,50 m →
NOZZLE SPACING 0,50 m - SPRAYING VOLUME (l/ha)

Part No.	Type	bar	psi	VMD	l/min	NOZZLE SPACING 0,50 m - SPRAYING VOLUME (l/ha)																
						4	5	6	7	8	9	10	12	14	16	18	20	25				
8259418	CV-IA 01	3,1	45	EG	0,43	129	103	86	74	65	57	52	43	37	32	29	26	21				
		4,1	60	EG	0,50	150	120	100	86	75	67	60	50	43	38	33	30	24				
		5,5	80	EG	0,57	171	137	114	98	86	76	68	57	49	43	38	34	27				
		6,9	100	MG	0,63	189	151	126	108	95	84	76	63	54	47	42	38	30				
		8,3	120	MG	0,68	204	163	136	117	102	91	82	68	58	51	45	41	33				
8259419	CV-IA 015	3,1	45	EG	0,62	186	149	124	106	93	83	74	62	53	47	41	37	30				
		4,1	60	EG	0,70	210	168	140	120	105	93	84	70	60	53	47	42	34				
		5,5	80	EG	0,82	246	197	164	141	123	109	98	82	70	62	55	49	39				
		6,9	100	MG	0,90	270	216	180	154	135	120	108	90	77	68	60	54	43				
		8,3	120	MG	0,99	297	238	198	170	149	132	119	99	85	74	66	59	48				
8259420	CV-IA 02	3,1	45	EG	0,78	234	187	156	134	117	104	94	78	67	59	52	47	37				
		4,1	60	EG	0,90	270	216	180	154	135	120	108	90	77	68	60	54	43				
		5,5	80	EG	1,02	306	245	204	175	153	136	122	102	87	77	68	61	49				
		6,9	100	MG	1,12	336	269	224	192	168	149	134	112	96	84	75	67	54				
		8,3	120	MG	1,22	366	293	244	209	183	163	146	122	105	92	81	73	59				
8259421	CV-IA 025	3,1	45	EG	1,04	312	250	208	178	156	139	125	104	89	78	69	62	50				
		4,1	60	EG	1,20	360	288	240	206	180	160	144	120	103	90	80	72	58				
		5,5	80	EG	1,38	414	331	276	237	207	184	166	138	118	104	92	83	66				
		6,9	100	MG	1,60	480	384	320	274	240	213	192	160	137	120	107	96	77				
		8,3	120	MG	1,75	525	420	350	300	263	233	210	175	150	131	117	105	84				
8259422	CV-IA 03	3,1	45	EG	1,22	366	293	244	209	183	163	146	122	105	92	81	73	59				
		4,1	60	EG	1,40	420	336	280	240	210	187	168	140	120	105	93	84	67				
		5,5	80	EG	1,64	492	394	328	281	246	219	197	164	141	123	109	98	79				
		6,9	100	MG	1,90	570	456	380	326	285	253	228	190	163	143	127	114	91				
		8,3	120	MG	2,03	609	487	406	348	305	271	244	203	174	152	135	122	97				
8259423	CV-IA 04	3,1	45	EG	1,56	468	374	312	267	234	208	187	156	134	117	104	94	75				
		4,1	60	EG	1,80	540	432	360	309	270	240	216	180	154	135	120	108	86				
		5,5	80	EG	2,07	621	497	414	355	311	276	248	207	177	155	138	124	99				
		6,9	100	MG	2,35	705	564	470	403	353	313	282	235	201	176	157	141	113				
		8,3	120	MG	2,58	774	619	516	442	387	344	310	258	221	194	172	155	124				
8259424	CV-IA 05	3,1	45	EG	2,00	600	480	400	343	300	267	240	200	171	150	133	120	96				
		4,1	60	EG	2,30	690	552	460	394	345	307	276	230	197	173	153	138	110				
		5,5	80	EG	2,65	795	636	530	454	398	353	318	265	227	199	177	159	127				
		6,9	100	EG	3,03	909	727	606	519	455	404	364	303	260	227	202	182	145				
		8,3	120	MG	3,30	990	792	660	566	495	440	396	330	283	248	220	198	158				
		10,4	150	MG	3,66	1098	878	732	627	549	488	439	366	314	275	244	220	176				

OPTIONALS



Pag. 293

Pag. 254-255

8253100	red
8253101	yellow
8253102	green
8253103	blue
8253104	orange
8253105	violet
8253106	black

X



CERAMIC



5,5÷13,8 bar

SERIE X CONO VUOTO

Ugelli per uso a pieno campo senza induzione d'aria

Caratteristiche

- Realizzati in ceramica, con un contenuto di Allumina del 99%;
- Pressione consigliata da 5,5 a 13,8 bar;
- Angolo di 85°;
- Riduce le gocce rendendole estremamente fini formando una copertura molto uniforme;
- Si sconsiglia l'utilizzo di questa serie in luoghi ventosi, poiché a causa della grandezza delle sue gocce si corre il rischio di un forte effetto deriva.

X SERIES EMPTY CONE

Nozzles for full-field use without air induction

Features

- Made in ceramic with a 99% alumina content;
- Pressure recommended ranges from 5,5 to 13,8 bar;
- 85° angle;
- Reduces the drops so they are extremely fine to give a really uniform coverage;
- This series of nozzles should not be used where it is windy because given the size of the drops there is the danger of a strong drift effect.

СЕРИЯ X С ПУСТЫМ КОНУСОМ

Форсунки для полевых опрыскивателей без подачи воздуха

Характеристики

- Из керамики с содержанием алюминия 99%.
- Рекомендуемое давление от 5,5 до 13,8 бар.
- Угол 85°.
- Уменьшает капли, делая их крайне тонкими, и образует однородное покрытие.
- Не рекомендуется использование этой серии в местах с ветром, в связи с тем, что размер капель содействует их сильному сносу ветром.



← 0,50 m →
NOZZLE SPACING 0,50 m - SPRAYING VOLUME (l/ha)

Part No.	Type	bar	psi	VMD	l/min	NOZZLE SPACING 0,50 m - SPRAYING VOLUME (l/ha)					
						3 Km/h	4 Km/h	5 Km/h	6 Km/h	7 Km/h	8 Km/h
8259384	X 0.50	5,5	80	MF	0,05	33	25	20	17	14	13
		6,9	100	MF	0,065	43	33	26	22	19	16
		10,4	150	MF	0,08	53	40	32	27	23	20
		13,8	200	MF	0,90	60	45	36	30	26	23
8259385	X 1	5,5	80	MF	0,13	87	65	52	43	37	33
		6,9	100	MF	0,14	93	70	56	47	40	35
		10,4	150	MF	0,16	107	80	64	53	46	40
		13,8	200	MF	0,19	127	95	76	63	54	48
8259386	X 2	5,5	80	MF	0,17	113	85	68	57	49	43
		6,9	100	MF	0,19	127	95	76	63	54	48
		10,4	150	MF	0,23	153	115	92	77	66	58
		13,8	200	MF	0,27	180	135	108	90	77	68
8259387	X 3	5,5	80	F	0,26	173	130	104	87	74	65
		6,9	100	MF	0,29	193	145	116	97	83	73
		10,4	150	MF	0,35	233	175	140	117	100	88
		13,8	200	MF	0,42	280	210	168	140	120	105

OPTIONALS



Pag. 293



Pag. 254-255

8253107	red
8253108	blue
8253109	white
8253110	orange
8253111	red
8253112	yellow

TM-IA



CERAMIC



2÷6 bar

SERIE TM-IA TURBO A INDUZIONE D'ARIA
Ugelli per uso a pieno campo a induzione d'aria

Caratteristiche

- Realizzati in ceramica, con un contenuto di Allumina del 99%;
- Pressione consigliata da 2 a 6 bar;
- Angolo di 150°;
- Dispone di un sistema Venturi a induzione d'aria nelle gocce, che consente a queste ultime di raggiungere grandi dimensioni, anche alle pressioni più elevate;
- Permette di lavorare con venti che raggiungono i 20 km/h.

TM-IA SERIES AIR INDUCTION TURBO
Air induction nozzles for full-field use

Features

- Made in ceramic with a 99% alumina content;
- Pressure recommended ranges from 2 to 6 bar;
- 150° angle
- It has a Venturi air induction system for the drops so they can become very big even at high pressures.
- It can be used even with 20 km/h winds.

СЕРИЯ TM-IA ТУРБО С ПОДАЧЕЙ ВОЗДУХА
Форсунки для полевых опрыскивателей с подачей воздуха

Характеристики

- Из керамики с содержанием алюминия 99%.
- Рекомендуемое давление от 2 до 6 бар.
- Угол 150°.
- Располагает системой Вентури с подачей воздуха в каплях, что позволяет последним достигать больших размеров, даже при большом давлении.
- Позволяет работать при ветре до 20 км/ч

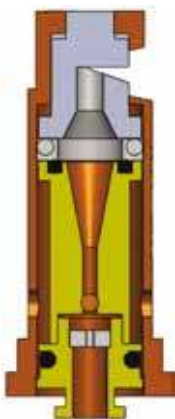

NOZZLE SPACING 1,00 m - SPRAYING VOLUME (l/ha)

Part No.	Type	bar	psi	VMD	l/min	NOZZLE SPACING 1,00 m - SPRAYING VOLUME (l/ha)																
						4 Km/h	5 Km/h	6 Km/h	7 Km/h	8 Km/h	9 Km/h	10 Km/h	12 Km/h	14 Km/h	16 Km/h	18 Km/h	20 Km/h	25 Km/h				
8259425	TM-IA 0,50	2	30	EG	0,50	75	60	50	43	38	33	30	25	21	19	17	15	12				
		3,1	45	EG	0,62	93	74	62	53	47	41	37	31	27	23	21	19	15				
		4,1	60	EG	0,72	108	86	72	62	54	48	43	36	31	27	24	22	17				
		5,2	75	EG	0,80	120	96	80	69	60	53	48	40	34	30	27	24	19				
8259426	TM-IA 0,75	2	30	EG	0,54	81	65	54	46	41	36	32	27	23	20	18	16	13				
		3,1	45	EG	0,66	99	79	66	57	50	44	40	33	28	25	22	20	16				
		4,1	60	EG	0,76	114	91	76	65	57	51	46	38	33	29	25	23	18				
		5,2	75	EG	0,86	129	103	86	74	65	57	52	43	37	32	29	26	21				
8259427	TM-IA 1	2	30	EG	0,67	101	80	67	57	50	45	40	34	29	25	22	20	16				
		3,1	45	EG	0,82	123	98	82	70	62	55	49	41	35	31	27	25	20				
		4,1	60	EG	0,95	143	114	95	81	71	63	57	48	41	36	32	29	23				
		5,2	75	EG	1,06	159	127	106	91	80	71	64	53	45	40	35	32	25				
8259428	TM-IA 1,5	2	30	EG	0,91	137	109	91	78	68	61	55	46	39	34	30	27	22				
		3,1	45	EG	1,12	168	134	112	96	84	75	67	56	48	42	37	34	27				
		4,1	60	EG	1,32	198	158	132	113	99	88	79	66	57	50	44	40	32				
		5,2	75	EG	1,46	219	175	146	125	110	97	88	73	63	55	49	44	35				
8259429	TM-IA 2	2	30	EG	1,25	146	116	96	84	75	67	56	48	42	37	34	27	22				
		3,1	45	EG	1,60	240	192	160	137	120	107	96	80	69	60	53	48	38				
		4,1	60	EG	1,85	278	222	185	159	139	123	111	93	79	69	62	56	44				
		5,2	75	EG	2,07	311	248	207	177	155	138	124	104	89	78	69	62	50				
8259430	TM-IA 2,5	2	30	EG	1,65	248	198	165	141	124	110	99	83	71	62	55	50	40				
		3,1	45	EG	1,98	297	238	198	170	149	132	119	99	85	74	66	59	48				
		4,1	60	EG	2,28	342	274	228	195	171	152	137	114	98	86	76	68	55				
		5,2	75	EG	2,54	381	305	254	218	191	169	152	127	109	95	85	76	61				
8259431	TM-IA 3	2	30	EG	2,00	300	240	200	171	150	133	120	100	86	75	67	60	48				
		3,1	45	EG	2,45	368	294	245	210	184	163	147	123	105	92	82	74	59				
		4,1	60	EG	2,81	422	337	281	241	211	187	169	141	120	105	94	84	67				
		5,2	75	EG	3,15	473	378	315	270	236	210	189	158	135	118	105	95	76				
8259432	TM-IA 4	2	30	EG	2,67	401	320	267	229	200	178	160	134	114	100	89	80	64				
		3,1	45	EG	3,26	489	391	326	279	245	217	196	163	140	122	109	98	78				
		4,1	60	EG	3,77	566	452	377	323	283	251	226	189	162	141	126	112	90				
		5,2	75	EG	4,22	633	506	422	362	317	281	253	211	181	158	141	127	101				
8259433	TM-IA 5	2	30	EG	4,50	675	540	450	386	338	300	270	225	193	169	150	135	108				
		3,1	45	EG	5,40	810	648	540	463	405	360	324	270	231	203	180	162	130				
		4,1	60	EG	6,18	936	756	618	510	437	383	340	306	255	219	191	170	153				
		5,2	75	EG	6,96	1062	858	702	586	500	437	383	340	306	255	219	191	170				
8259434	TM-J 7,5	2	30	EG	5,10	765	612	510	437	383	340	306	255	219	191	170	153	122				
		3,1	45	EG	6,24	936	749	624	535	468	416	374	312	267	234	208	187	150				
		4,1	60	EG	6,85	1028	822	685	587	514	457	411	343	294	257	228	206	164				
		5,2	75	EG	7,45	1118	894	745	639	559	497	447	373	319	279	248	224	179				
		6,2	90	EG	8,00	1200	960	800	686	600	533	480	400	343	300	267	240	192				

OPTIONALS



Pag. 293



Pag. 254-255

8253028	red
8253029	yellow
8253030	green
8253031	blue
8253069	orange
8253070	brown
8253071	black
8253126	white
8253127	light blue
8253128	violet

PB



CERAMIC



2÷4 bar

SERIE PB ECCENTRICO

Ugelli per l'applicazione a banda stretta in punta di barra di barra

Caratteristiche

- Getto piatto, decentrato, usato in punta di barra;
- Angolo di 60°;
- Pressione di lavoro da 2 a 4 bar;
- Usato in applicazioni a banda stretta o altre complementari con barra, quali ad esempio: cordoni, fasce tagliafuoco, pulizia di burroni, bordi di autostrade, fertilizzanti liquidi a banda o orientati.

PB SERIES BOOM TIP

Nozzles for narrow strip application on boom tip

Features

- Flat, offset jet used on the boom tip;
- 60° angle;
- Working pressure ranges from 2 to 4 bar;
- Used for narrow strip applications or other accessories with boom, such as, for example: cordons, firebreak strips, cleaning ravines, motorway edges, liquid fertilisers.

СЕРИЯ РВ ЭКСЦЕНТРИКОВАЯ

Форсунки для использования в узком диапазоне на конце штанги

Характеристики

- Плоская, смещенная струя, используется на конце штанг.
- Угол 60°.
- Рабочее давление от 2 до 4 бар.
- Используется в узком диапазоне или в качестве комплектующей штанги, например, на кордонах, противопожарных ограждениях, для очистки оврагов, обочин автомагистралей, с жидкими удобрениями.



← 0,50 m →
NOZZLE SPACING 0,50 m - SPRAYING VOLUME (l/ha)

Part No.	Type	bar	psi	VMD	l/min	NOZZLE SPACING 0,50 m - SPRAYING VOLUME (l/ha)															
						4 Km/h	5 Km/h	6 Km/h	7 Km/h	8 Km/h	9 Km/h	10 Km/h	12 Km/h	14 Km/h	16 Km/h	18 Km/h	20 Km/h	25 Km/h			
8259457	PB 01	2	30	M	0,32	96	77	64	55	48	43	38	32	27	24	21	19	15			
		3,1	45	F	0,41	123	98	82	70	62	55	49	41	35	31	27	25	20			
		4,1	60	F	0,46	138	110	92	79	69	61	55	46	39	35	31	28	22			
8259458	PB 015	2	30	M	0,50	150	120	100	86	75	67	60	50	43	38	33	30	24			
		3,1	45	F	0,61	183	146	122	105	92	81	73	61	52	46	41	37	29			
8259459	PB 02	2	30	M	0,66	198	158	132	113	99	88	79	66	57	50	44	40	32			
		3,1	45	M	0,82	246	197	164	141	123	109	98	82	70	62	55	49	39			
		4,1	60	F	0,95	285	228	190	163	143	127	114	95	81	71	63	57	46			
8259460	PB 03	2	30	M	1,00	300	240	200	171	150	133	120	100	86	75	67	60	48			
		3,1	45	M	1,25	375	300	250	214	188	167	150	125	107	94	83	75	60			
		4,1	60	M	1,43	429	343	286	245	215	191	172	143	123	107	95	86	69			
8259461	PB 04	2	30	M	1,32	396	317	264	226	198	176	158	132	113	99	88	79	63			
		3,1	45	M	1,62	486	389	324	278	243	216	194	162	139	122	108	97	78			
		4,1	60	M	1,89	567	454	378	324	284	252	227	189	162	142	126	113	91			
8259462	PB 05	2	30	M	1,67	501	401	334	286	251	223	200	167	143	125	111	100	80			
		3,1	45	M	2,07	621	497	414	355	311	276	248	207	177	155	138	124	99			
		4,1	60	F	2,39	717	574	478	410	359	319	287	239	205	179	159	143	115			
8259567	PB 06	2	30	M	2,02	606	485	404	346	303	269	242	202	173	152	135	121	97			
		3,1	45	M	2,49	747	598	498	427	374	332	299	249	213	187	166	149	120			
		4,1	60	F	2,86	858	686	572	490	429	381	343	286	245	215	191	172	137			

OPTIONALS



Pag. 293



Pag. 254-255

8253000	red
8253001	yellow
8253002	green
8253003	blue
8253041	white
8253042	orange
8253043	brown
8253048	black
8253118	grey
8253119	violet

PB-IA



CERAMIC



SERIE PB-IA ECCENTRICO A INDUZIONE D'ARIA - Ugelli per l'applicazione a banda stretta in punta di barra

Caratteristiche

- Getto piatto, decentrato, a induzione d'aria, usato in punta di barra;
- Angolo di 60°;
- Pressione di lavoro da 2 a 7,5 bar;
- Buon controllo di deriva con venti fino a 15 km/h;
- Camera rimovibile per facilitarne la pulizia;
- Usato in applicazioni a banda stretta o altre complementari con barra, quali ad esempio: cordoni, fasce tagliafuoco, pulizia di burroni, bordi di autostrade, fertilizzanti liquidi a banda o orientati.

PB-IA SERIES AIR INDUCTION BOOM TIP
Nozzles for narrow strip application on boom tip

Features

- Flat, offset air induction jet used on the boom tip;
- 60° angle;
- Working pressure ranges from 2 to 7,5 bar;
- Good control of drift with winds up to 15 km/h;
- Removable chamber for easier cleaning;
- Used for narrow strip applications or other accessories with boom, such as, for example: cordons, firebreak strips, cleaning ravines, motorway edges, strip or oriented liquid fertilisers.

СЕРИЯ PB-IA ЭКСЦЕНТРИКОВАЯ С ПОДАЧЕЙ ВОЗДУХА - Форсунки для применения в узком диапазоне на конце штанги

Характеристики

- Плоская смещенная струя с подачей воздуха, используется на конце штанги.
- Угол 60°.
- Рабочее давление от 2 до 7,5 бар.
- Хороший контроль сноса при ветре до 15 км/ч.
- Снимаемая камера для удобства очистки.
- Используется в узком диапазоне или в качестве комплектующей штанги, например, на кордонах, противопожарных ограждениях, для очистки оврагов, обочин автомагистралей, с жидкими удобрениями.



← 0,50 m →
NOZZLE SPACING 0,50 m - SPRAYING VOLUME (l/ha)

Part No.	Type	bar	psi	VMD	l/min	NOZZLE SPACING 0,50 m - SPRAYING VOLUME (l/ha)															
						4 Km/h	5 Km/h	6 Km/h	7 Km/h	8 Km/h	9 Km/h	10 Km/h	12 Km/h	14 Km/h	16 Km/h	18 Km/h	20 Km/h	25 Km/h			
8259463	PB-IA 60-01	2	30	EG	0,38	114	91	76	65	57	51	46	38	33	29	25	23	18			
		3,4	50	MG	0,43	129	103	86	74	65	57	52	43	37	32	29	26	21			
		4,8	70	MG	0,50	150	120	100	86	75	67	60	50	43	38	33	30	24			
		6,2	90	G	0,56	168	134	112	96	84	75	67	56	48	42	37	34	27			
		7,6	110	G	0,62	186	149	124	106	93	83	74	62	53	47	41	37	30			
8259464	PB-IA 60-015	2	30	EG	0,48	144	115	96	82	72	64	58	48	41	36	32	29	23			
		3,4	50	MG	0,65	195	156	130	111	98	87	78	65	56	49	43	39	31			
		4,8	70	MG	0,77	231	185	154	132	116	103	92	77	66	58	51	46	37			
		6,2	90	MG	0,86	258	206	172	147	129	115	103	86	74	65	57	52	41			
		7,6	110	G	0,95	285	228	190	163	143	127	114	95	81	71	63	57	46			
8259465	PB-IA 60-02	2	30	EG	0,67	201	161	134	115	101	89	80	67	57	50	45	40	32			
		3,4	50	EG	0,89	267	214	178	153	134	119	107	89	76	67	59	53	43			
		4,8	70	MG	1,04	312	250	208	178	156	139	125	104	89	78	69	62	50			
		6,2	90	MG	1,18	354	283	236	202	177	157	142	118	101	89	79	71	57			
		7,6	110	G	1,29	387	310	258	221	194	172	155	129	111	97	86	77	62			
8259466	PB-IA 60-025	2	30	EG	0,83	249	199	166	142	125	111	100	83	71	62	55	50	40			
		3,4	50	EG	1,09	327	262	218	187	164	145	131	109	93	82	73	65	52			
		4,8	70	MG	1,29	387	310	258	221	194	172	155	129	111	97	86	77	62			
		6,2	90	MG	1,46	438	350	292	250	219	195	175	146	125	110	97	88	70			
		7,6	110	G	1,61	483	386	322	276	242	215	193	161	138	121	107	97	77			
8259467	PB-IA 60-03	2	30	EG	1,01	303	242	202	173	152	135	121	101	87	76	67	61	48			
		3,4	50	EG	1,33	399	319	266	228	200	177	160	133	114	100	89	80	64			
		4,8	70	MG	1,58	474	379	316	271	237	211	190	158	135	119	105	95	76			
		6,2	90	MG	1,80	540	432	360	309	270	240	216	180	154	135	120	108	86			
		7,6	110	MG	1,97	591	473	394	338	296	263	236	197	169	148	131	118	95			
8259468	PB-IA 60-04	2	30	EG	1,33	399	319	266	228	200	177	160	133	114	100	89	80	64			
		3,4	50	EG	1,73	519	415	346	297	260	231	208	173	148	130	115	104	83			
		4,8	70	MG	2,06	618	494	412	353	309	275	247	206	177	155	137	124	99			
		6,2	90	MG	2,32	696	557	464	398	348	309	278	232	199	174	155	139	111			
		7,6	110	MG	2,57	771	617	514	441	386	343	308	257	220	193	171	154	123			
8259469	PB-IA 60-05	2	30	EG	1,64	492	394	328	281	246	219	197	164	141	123	109	98	79			
		3,4	50	EG	2,14	642	514	428	367	321	285	257	214	183	161	143	128	103			
		4,8	70	EG	2,56	768	614	512	439	384	341	307	256	219	192	171	154	123			
		6,2	90	MG	2,87	861	689	574	492	431	383	344	287	246	215	191	172	138			
		7,6	110	MG	3,17	951	761	634	543	476	423	380	317	272	238	211	190	152			
8259470	PB-IA 60-06	2	30	EG	2,00	600	480	400	343	300	267	240	204	175	153	133	120	98			
		3,4	50	EG	2,57	771	617	514	441	386	343	308	260	223	195	171	154	125			
		4,8	70	EG	3,03	909	727	606	519	455	404	364	308	264	231	202	182	148			
		6,2	90	MG	3,53	1.059	847	706	605	530	471	424	344	295	258	235	212	165			
		7,6	110	MG	3,85	1.155	924	770	660	577	513	462	381	326	285	256	231	183			

OPTIONALS



Pag. 293



Pag. 254-255

8253028	red
8253029	yellow
8253030	green
8253031	blue
8253069	orange
8253070	brown
8253071	black
8253126	white
8253127	light blue
8253128	violet

MX



CERAMIC



2÷5 bar

SERIE MX

Ugelli per uso a pieno campo

Caratteristiche

- Tutti i modelli sono realizzati in ceramica, con un contenuto di allumina del 99%, corpo in Resina acetaleica
- Pressione consigliata da 2 a 6 bar
- L'impiego è consigliato in impianti senza barra.
- Utilizzabile come ugello fine barra per estendere la larghezza del trattamento
- Può raggiungere i 6.5 metri di estensione anche a basse pressioni
- L'impiego è particolarmente consigliato per pascoli, foreste, ferrovie, campi da golf, e impianti ATV su moto quad.

MX SERIES

Nozzles for full-field use

Features

- Made in ceramic with a 99% Alumina content, body in Acetal resin;
- Pressure recommended ranges from 2 to 6 bar;
- Recommended use on systems without bars.
- Can be used as a nozzle at the end of the bar to extend its reach.
- Can reach an extension of up to 6.5 m, even at low pressures.
- Particularly indicated for treating grassland, forests, railroads, golf courses and on All-Terrain Vehicles (quad bikes).

СЕРИЯ MX

Форсунки для полевых опрыскивателей

Характеристики

- Все модели из керамики с содержанием алюминия 99%, корпус из ацетальной смолы
- Рекомендуемое давление от 2 до 6 бар.
- Рекомендуется использование в установках без штанг.
- Может использоваться как форсунка на конце штанги для увеличения площади обработки.
- Может достигать дальности действия 6,5 метров даже при низком давлении.
- Рекомендуется использование на пастбищах, в лесах, на железной дороге, полях для игры в гольф и системах ATV для мотоциклов quad.



Pack Blister 2 PCS



Part No.	Type	SPRAYING VOLUME (l/h)														L m	H m	
		bar		psi		VMD l/min	@ 3,0 bar											
		2	3	4	5		6	8	10	12	14	16	18	20				
8259514	MX 008	2	30	EG	2,65	80	53	40	32	27	23	20	18	16	5,00	1,60		
		3	45	EG	3,30	99	66	50	40	33	28	25	22	20				
		4	60	EG	4,45	134	89	67	53	45	38	33	30	27				
		5	75	EG	4,95	149	99	74	59	50	42	37	33	30				
8259515	MX 010	2	30	EG	3,40	89	60	45	36	30	26	22	20	18	5,70	1,60		
		3	45	EG	4,10	108	72	54	43	36	31	27	24	22				
		4	60	EG	4,85	128	85	64	51	43	36	32	28	26				
8259516	MX 012	2	30	EG	3,80	98	66	49	39	33	28	25	22	20	5,80	1,60		
		3	45	EG	4,65	120	80	60	48	40	34	30	27	24				
		4	60	EG	5,35	138	92	69	55	46	40	35	31	28				
8259517	MX 015	2	30	EG	5,00	129	86	65	52	43	37	32	29	26	5,80	1,60		
		3	45	EG	6,00	155	103	78	62	52	44	39	34	31				
		4	60	EG	7,00	181	121	91	72	60	52	45	40	36				
8259518	MX 020	2	30	EG	6,50	157	105	79	63	52	45	39	35	31	6,20	1,60		
		3	45	EG	7,90	191	127	96	76	64	55	48	42	38				
		4	60	EG	9,60	232	155	116	93	77	66	58	52	46				
8259519	MX 024	2	30	EG	7,70	178	118	89	71	59	51	44	39	36	6,50	1,60		
		3	45	EG	9,60	222	148	111	89	74	63	55	49	44				
		4	60	EG	11,10	256	171	128	102	85	73	64	57	51				
8259520	MX 032	2	30	EG	10,10	233	155	117	93	78	67	58	52	47	6,50	1,60		
		3	45	EG	12,20	282	188	141	113	94	80	70	63	56				
		4	60	EG	13,80	318	212	159	127	106	91	80	71	64				
		5	75	EG	14,80	342	228	171	137	114	98	85	76	68				

Utilizzo / Use / Применение

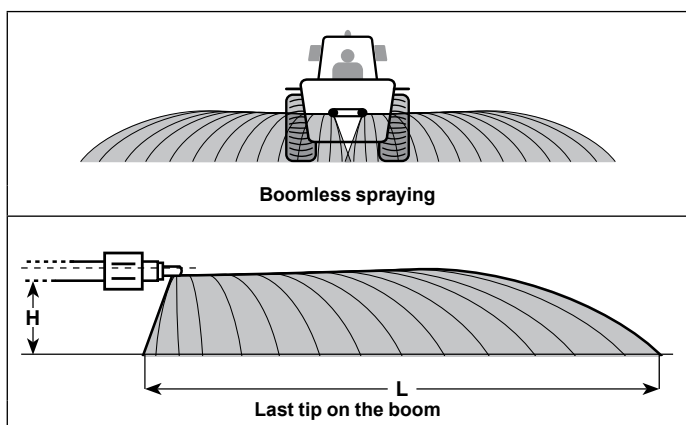

OPTIONALS

Part No.	Type	Pack
1 K00108006	Quick	2
8294020	G 3/8	
2 8294021	G 1/2	25
8294022	G 3/4	

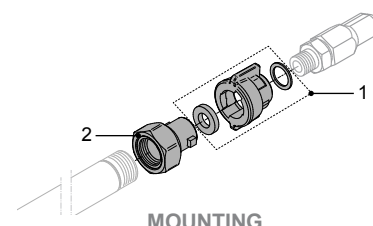

Kit quad per ugelli MX

Quad kit for MX nozzles

Комплект для форсунок MX



Part No.	Pack
K00700013	1

OPTIONALS



Pag. 283

DIMENSIONS

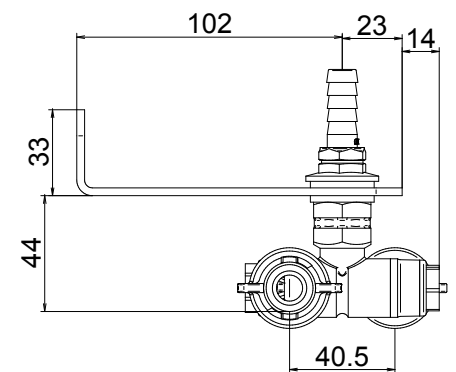

Utilizzo / Use / Применение

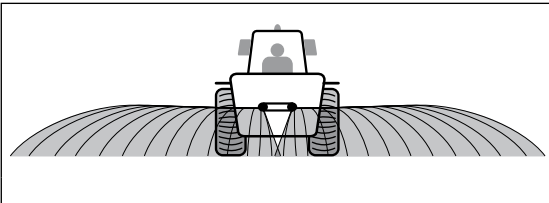

TKP



PLASTIC (POM)



SERIE DEFLETTORE POLIACETALE

Ugelli per uso a pieno campo senza induzione d'aria

Caratteristiche

- Ugello Deflettore resina acetalica;
- Angolo di 130° a 2.5 bar;
- Pressione consigliata da 1 a 3 bar;
- Dispone di un foro grande che ne facilita la pulizia e riduce gli intasamenti;
- Ottima resa nelle applicazioni di erbicidi sulla superficie totale con nebulizzatori costali.

POLYACETAL DEFLECTOR SERIES

Nozzles for full-field use without air induction

Features

- Acetal resin deflector nozzle;
- 130° angle at 2.5 bar;
- Pressure recommended ranges from 1 to 3 bar;
- This series has a big hole which facilitates cleaning and reduces clogging;
- Excellent yield in applying herbicides over the whole surface with nebulisers.

СЕРИЯ ДЕФЛЕКТОРОВ ИЗ ПОЛИАЦЕТАЛИ

Форсунки для полевых опрыскивателей без подачи воздуха

Характеристики

- Дефлектор из ацетальной смолы.
- Угол 130° при 2,5 бар.
- Рекомендуемое давление от 1 до 3 бар.
- Характеризуется большим отверстием, упрощающим очистку и предупреждающим засорение.
- Превосходная эффективность при распылении эрбицидов на всей площади распылителями.



NOZZLE SPACING 1,00 m - SPRAYING VOLUME (l/ha)

Part No.	Type	bar		VMD l/min	NOZZLE SPACING 1,00 m - SPRAYING VOLUME (l/ha)														
		psi	psi		4	5	6	7	8	9	10	12	14	16	18	20	25		
8259395	TKP 0,75	1	15	M	0,34	51	41	34	29	26	23	20	17	15	13	11	10	8	
		2	30	F	0,50	75	60	50	43	38	33	30	25	21	19	17	15	12	
		3,1	45	F	0,62	93	74	62	53	47	41	37	31	27	23	21	19	15	
8259396	TKP 1	1	15	M	0,46	69	55	46	39	35	31	28	23	20	17	15	14	11	
		2	30	F	0,68	102	82	68	58	51	45	41	34	29	26	23	20	16	
		3,1	45	F	0,84	126	101	84	72	63	56	50	42	36	32	28	25	20	
8259397	TKP 1,5	1	15	G	0,70	105	84	70	60	53	47	42	35	30	26	23	21	17	
		2	30	M	1,00	150	120	100	86	75	67	60	50	43	38	33	30	24	
		3,1	45	F	1,24	186	149	124	106	93	83	74	62	53	47	41	37	30	
8259398	TKP 2	1	15	G	1,19	179	143	119	102	89	79	71	60	51	45	40	36	29	
		2	30	M	1,32	198	158	132	113	99	88	79	66	57	50	44	40	32	
		3,1	45	F	1,60	240	192	160	137	120	107	96	80	69	60	53	48	38	
8259399	TKP 2,5	1	15	G	1,20	180	144	120	103	90	80	72	60	51	45	40	36	29	
		2	30	M	1,65	248	198	165	141	124	110	99	83	71	62	55	50	40	
		3,1	45	F	1,98	297	238	198	170	149	132	119	99	85	74	66	59	48	
8259400	TKP 3	1	15	G	1,53	230	184	153	131	115	102	92	77	66	57	51	46	37	
		2	30	M	2,00	300	240	200	171	150	133	120	100	86	75	67	60	48	
		3,1	45	F	2,45	368	294	245	210	184	163	147	123	105	92	82	74	59	
8259401	TKP 4	1	15	G	1,95	293	234	195	167	146	130	117	98	84	73	65	59	47	
		2	30	M	2,67	401	320	267	229	200	178	160	134	114	100	89	80	64	
		3,1	45	M	3,26	489	391	326	279	245	217	196	163	140	122	109	98	78	
8259402	TKP 5	1	15	G	2,35	353	282	235	201	176	157	141	118	101	88	78	71	56	
		2	30	M	3,25	488	390	325	279	244	217	195	163	139	122	108	98	78	
		3,1	45	M	3,97	596	476	397	340	298	265	238	199	170	149	132	119	95	
8259403	TKP 7,5	1	15	G	3,54	531	425	354	303	266	236	212	177	152	133	118	106	85	
		2	30	M	5,10	765	612	510	437	383	340	306	255	219	191	170	153	122	
		3,1	45	M	6,24	936	749	624	535	468	416	374	312	267	234	208	187	150	

OPTIONALS



Pag. 293

Pag. 254-255

8253113	green
8253114	blue
8253115	orange
8253116	brown
8253117	black

MCP



PLASTIC (POM)
CERAMIC



2÷6 bar

SERIE MCP CONO VUOTO – POLIACETALE
Ugelli per uso a pieno campo senza induzione d'aria

Caratteristiche

- Realizzati in resina acetica e camica;
- Pressione consigliata 2 a 6 bar;
- Angolo di 90°;
- Consente una copertura fogliare e una penetrazione eccellenti nel punto da irrorare;
- La serie MCP a CONO VUOTO può essere usata nei nebulizzatori a barre o per atomizzatori.

MCP SERIES EMPTY CONE – POLYACETAL
Nozzles for full-field use without air induction

Features

- Made in acetal resin and cramic;
- Pressure recommended ranges from 2 to 6 bar;
- 90° angle;
- Provides excellent leaf coverage and penetration of the point sprayed;
- The EMPTY CONE MCP series can be used with mist blower booms or for atomisers.

СЕРИЯ MCP С ПУСТЫМ КОНУСОМ - ПОЛИАЦЕТАЛЬ
Форсунки для полевых опрыскивателей без подачи воздуха

Характеристики

- Из ацетальной смолы и керамики
- Рекомендуемое давление от 2 до 6 бар.
- Угол 90°.
- Обеспечивает превосходное покрытие листья и проникновение в точку орошения.
- Серия MCP с ПУСТЫМ КОНУСОМ для штанг. опрыскивателей и распылителей.



← 0,50 m →
NOZZLE SPACING 0,50 m - SPRAYING VOLUME (l/ha)

Part No.	Type	bar		VMD	l/min	NOZZLE SPACING 0,50 m - SPRAYING VOLUME (l/ha)															
		psi	psi			4 Km/h	5 Km/h	6 Km/h	7 Km/h	8 Km/h	9 Km/h	10 Km/h	12 Km/h	14 Km/h	16 Km/h	18 Km/h	20 Km/h	25 Km/h			
8259388	MCP 0,5	2	30	F	0,18	54	43	36	31	27	24	22	18	15	14	12	121	9			
		3,1	45	F	0,22	66	53	44	38	33	29	26	22	19	17	15	147	11			
		4,1	60	F	0,25	75	60	50	43	38	33	30	25	21	19	17	168	12			
		5,2	75	F	0,28	84	67	56	48	42	37	34	28	24	21	19	188	13			
8259389	MCP 1	2	30	F	0,22	66	53	44	38	33	29	26	22	19	17	15	13	11			
		3,1	45	F	0,28	84	67	56	48	42	37	34	28	24	21	19	17	13			
		4,1	60	F	0,32	96	77	64	55	48	43	38	32	27	24	21	19	15			
		5,2	75	F	0,35	105	84	70	60	53	47	42	35	30	26	23	21	17			
8259390	MCP 1,5	2	30	F	0,30	90	72	60	51	45	40	36	30	26	23	20	18	14			
		3,1	45	F	0,37	111	89	74	63	56	49	44	37	32	28	25	22	18			
		4,1	60	F	0,43	129	103	86	74	65	57	52	43	37	32	29	26	21			
		5,2	75	F	0,48	144	115	96	82	72	64	58	48	41	36	32	29	23			
8259391	MCP 2	2	30	F	0,46	138	110	92	79	69	61	55	46	39	35	31	28	22			
		3,1	45	F	0,56	168	134	112	96	84	75	67	56	48	42	37	34	27			
		4,1	60	F	0,64	192	154	128	110	96	85	77	64	55	48	43	38	31			
		5,2	75	F	0,72	216	173	144	123	108	96	86	72	62	54	48	43	35			
8259392	MCP 3	2	30	F	0,64	192	154	128	110	96	85	77	64	55	48	43	38	31			
		3,1	45	F	0,77	231	185	154	132	116	103	92	77	66	58	51	46	37			
		4,1	60	F	0,88	264	211	176	151	132	117	106	88	75	66	59	53	42			
		5,2	75	F	0,99	297	238	198	170	149	132	119	99	85	74	66	59	48			
8259393	MCP 4	2	30	F	0,88	264	211	176	151	132	117	106	88	75	66	59	53	42			
		3,1	45	F	1,08	324	259	216	185	162	144	130	108	93	81	72	65	52			
		4,1	60	F	1,25	375	300	250	214	188	167	150	125	107	94	83	75	60			
		5,2	75	F	1,44	432	346	288	247	216	192	173	144	123	108	96	86	69			
					6,2	90	F	1,56	468	374	312	267	234	208	187	156	134	117	104	94	75

OPTIONALS



Pag. 293



Pag. 254-255

8253100	red
8253101	yellow
8253102	green
8253103	blue
8253104	orange
8253105	violet
8253106	black



PLASTIC (POM)



EZ



SERIE EZ - Ugelli per uso a pieno campo a induzione d'aria

Caratteristiche

- Getto piatto con aspirazione d'aria;
- Angolo di 110°;
- Pressione consigliata 3 a 8 bar;
- Potenziale di deriva estremamente basso persino alle pressioni più alte;
- Applicazione in colture a pieno campo e colture speciali.

EZ SERIES - Air induction nozzles for full-field use

Features

- Air-aspirating flat-spray tip.
- 110° angle
- Pressure recommended ranges from 3 to 8 bar;
- Extremely low drift potential, even for higher pressures;
- Application in field crops and special cultures.

СЕРИЯ EZ - Форсунки для полевых опрыскивателей с подачей воздуха

Характеристики

- Плоская струя с всасыванием воздуха.
- Угол 110°.
- Рекомендуемое давление от 3 до 8 бар.
- Крайне низкая вероятность сноса ветром даже при высоком давлении.
- Применение с полевыми и специальными культурами.



Part No.	Part No.	Type	bar	psi	VMD	NOZZLE SPACING 0,50 m - SPRAYING VOLUME (l/h)									
						l/min	5 Km/h	6 Km/h	7 Km/h	8 Km/h	10 Km/h	12 Km/h	14 Km/h	16 Km/h	18 Km/h
8261000	8259497	EZ 015	3	43,5	MG	0.59	142	118	101	89	71	59	51	44	39
			4	58	G	0.68	163	136	117	102	82	68	58	51	45
			5	72,5	G	0.76	182	152	130	114	91	76	65	57	51
			6	87	M	0.83	199	166	142	125	100	83	71	62	55
			7	101,5	M	0.90	216	180	154	135	108	90	77	68	60
8261001	8259498	EZ 02	3	43,5	MG	0.80	192	160	137	120	96	80	69	60	53
			4	58	G	0.92	221	184	158	138	110	92	79	69	61
			5	72,5	G	1.03	247	206	177	155	124	103	88	77	69
			6	87	G	1.13	271	226	194	170	136	113	97	85	75
			7	101,5	M	1.22	293	244	209	183	146	122	105	92	81
8261002	8259499	EZ 025	2	30	MG	0.81	194	162	139	122	97	81	69	61	54
			3	43,5	MG	0.99	238	198	170	149	119	99	85	74	66
			4	58	MG	1.15	276	230	197	173	138	115	99	86	77
			5	72,5	G	1.28	307	256	219	192	154	128	110	96	85
			6	87	M	1.40	336	280	240	210	168	140	120	105	93
8261003	8259500	EZ 03	2	30	EG	0.97	233	194	166	146	116	97	83	73	65
			3	43,5	EG	1.19	286	238	204	179	143	119	102	89	79
			4	58	G	1.37	329	274	235	206	164	137	117	103	91
			5	72,5	G	1.53	367	306	262	230	184	153	131	115	102
			6	87	G	1.68	403	336	288	252	202	168	144	126	112
8261004	8259501	EZ 04	7	101,5	M	1.81	434	362	310	272	217	181	155	136	121
			8	116	M	1.94	466	388	333	291	233	194	166	146	129
			3	43,5	EG	1.58	379	316	271	237	190	158	135	119	105
			4	58	G	1.82	437	364	312	273	218	182	156	137	121
			5	72,5	G	2.04	490	408	350	306	245	204	175	153	136
8261005	8259502	EZ 05	6	87	G	2.23	535	446	382	335	268	223	191	167	149
			7	101,5	M	2.41	578	482	413	362	289	241	207	181	161
			8	116	M	2.58	619	516	442	387	310	258	221	194	172
			2	30	EG	1.61	386	322	276	242	193	161	138	121	107
			3	43,5	MG	1.97	473	394	338	296	236	197	169	148	131
8261006	8259555	EZ 06	4	58	MG	2.28	547	456	391	342	274	228	195	171	152
			5	72,5	MG	2.55	612	510	437	383	306	255	219	191	170
			6	87	M	2.79	670	558	478	419	335	279	239	209	186
			7	101,5	M	3.01	722	602	516	452	361	301	258	226	201
			8	116	M	3.22	773	644	552	483	386	322	276	242	215
8261007	8259556	EZ 08	2	30	EG	1.93	463	386	331	290	232	193	165	145	129
			3	43,5	EG	2.36	566	472	405	354	283	236	202	177	157
			4	58	MG	2.73	655	546	468	410	328	273	234	205	182
			5	72,5	MG	3.05	732	610	523	458	366	305	261	229	203
			6	87	M	3.34	802	668	573	501	401	334	286	251	223
8261007	8259556	EZ 08	7	101,5	M	3.61	866	722	619	542	433	361	309	271	241
			8	116	M	3.86	926	772	662	579	463	386	331	290	257
			2	30	EG	2.58	619	516	442	387	310	258	221	194	172
			3	43,5	EG	3.16	758	632	542	474	379	316	271	237	211
			4	58	MG	3.65	876	730	626	548	438	365	313	274	243
8261007	8259556	EZ 08	5	72,5	MG	4.08	979	816	699	612	490	408	350	306	272
			6	87	MG	4.47	1073	894	766	671	536	447	383	335	298
			7	101,5	M	4.83	1159	966	828	725	580	483	414	362	322
			8	116	M	5.16	1238	1032	885	774	619	516	442	387	344

OPTIONALS



Pag. 293



Pag. 254-255

8253008	red
8253009	yellow
8253010	green
8253011	blue
8253056	orange
8253057	brown
8253049	black
8253120	grey
8253121	light blue



PLASTIC (POM)



1÷6 bar

EZK



Generalitat de Catalunya
Departament d'Agricultura
Alimentació i Acció Rural



SERIE EZK - Ugelli per uso a pieno campo a induzione d'aria

Caratteristiche

- Ugello a spruzzo piatto ad aspirazione d'aria
- Angolo di spruzzo: 110°
- Pressione consigliata 1 a 6 bar;
- Potenziale di deriva estremamente basso ed effetto di riduzione delle perdite nell'intervallo di pressione fino a 3,0 bar.

EZK SERIES
Air induction nozzles for full-field use

Features

- Air-aspirating flat-spray tip;
- Spray angle: 110°
- Pressure recommended ranges from 1 to 6 bar;
- Extremely low drift potential and loss-reducing effect in pressure range up to 3.0 bar.

СЕРИЯ EZK

Форсунки для полевых опрыскивателей с подачей воздуха

Характеристики

- Форсунки с плоской струей с всасыванием воздуха.
- Угол распыления: 110°.
- Рекомендуемое давление от 1 до 6 бар.
- Крайне низкая вероятность сноса ветром и эффект сниж.потерь при давлении до 3.0 бар

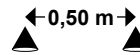

NOZZLE SPACING 0,50 m - SPRAYING VOLUME (l/ha)

Part No.	Part No.	Type	NOZZLE SPACING 0,50 m - SPRAYING VOLUME (l/ha)															
			bar	psi	VMD	l/min	5 Km/h	6 Km/h	7 Km/h	8 Km/h	10 Km/h	12 Km/h	14 Km/h	16 Km/h	18 Km/h			
8261008	8259491	EZK 110/015	1,5	21,8	G	0,42	101	84	72	63	50	42	36	32	28			
			2	30	G	0,48	115	96	82	72	58	48	41	36	32			
			2,5	36,3	M	0,54	130	108	93	81	65	54	46	41	36			
			3	43,5	M	0,59	142	118	101	89	71	59	51	44	39			
			3,5	50,8	M	0,63	151	126	108	95	76	63	54	47	42			
			4	58	M	0,68	163	136	117	102	82	68	58	51	45			
			4,5	65,3	M	0,72	173	144	123	108	86	72	62	54	48			
			5	72,5	M	0,76	182	152	130	114	91	76	65	57	51			
			6	87	M	0,83	199	166	142	125	100	83	71	62	55			
8261009	8259492	EZK 110/02	1,5	21,8	G	0,56	134	112	96	84	67	56	48	42	37			
			2	30	G	0,65	156	130	111	98	78	65	56	49	43			
			2,5	36,3	G	0,73	175	146	125	110	88	73	63	55	49			
			3	43,5	G	0,80	192	160	137	120	96	80	69	60	53			
			3,5	50,8	M	0,86	206	172	147	129	103	86	74	65	57			
			4	58	M	0,92	221	184	158	138	110	92	79	69	61			
			4,5	65,3	M	0,98	235	196	168	147	118	98	84	74	65			
			5	72,5	M	1,03	247	206	177	155	124	103	88	77	69			
			6	87	M	1,13	271	226	194	170	136	113	97	85	75			
8261010	8259493	EZK 110/025	1,5	21,8	MG	0,70	168	140	120	105	84	70	60	53	47			
			2	30	MG	0,81	194	162	139	122	97	81	69	61	54			
			2,5	36,3	G	0,91	218	182	156	137	109	91	78	68	61			
			3	43,5	G	0,99	238	198	170	149	119	99	85	74	66			
			3,5	50,8	G	1,07	257	214	183	161	128	107	92	80	71			
			4	58	G	1,15	276	230	197	173	138	115	99	86	77			
			4,5	65,3	M	1,22	293	244	209	183	146	122	105	92	81			
			5	72,5	M	1,28	307	256	219	192	154	128	110	96	85			
			6	87	M	1,40	336	280	240	210	168	140	120	105	93			
8261011	8259494	EZK 110/03	1,5	21,8	MG	0,84	202	168	144	126	101	84	72	63	56			
			2	30	MG	0,97	233	194	166	146	116	97	83	73	65			
			2,5	36,3	MG	1,08	259	216	185	162	130	108	93	81	72			
			3	43,5	G	1,19	286	238	204	179	143	119	102	89	79			
			3,5	50,8	G	1,28	307	256	219	192	154	128	110	96	85			
			4	58	G	1,37	329	274	235	206	164	137	117	103	91			
			4,5	65,3	G	1,46	350	292	250	219	175	146	125	110	97			
			5	72,5	G	1,53	367	306	262	230	184	153	131	115	102			
			6	87	M	1,68	403	336	288	252	202	168	144	126	112			
8261012	8259495	EZK 110/04	1	14,5	MG	0,91	218	182	156	137	109	91	78	68	61			
			1,5	21,8	MG	1,12	269	224	192	168	134	112	96	84	75			
			2	30	MG	1,29	310	258	221	194	155	129	111	97	86			
			2,5	36,3	MG	1,44	346	288	247	216	173	144	123	108	96			
			3	43,5	MG	1,58	379	316	271	237	190	158	135	119	105			
			3,5	50,8	G	1,71	410	342	293	257	205	171	147	128	114			
			4	58	G	1,82	437	364	312	273	218	182	156	137	121			
			4,5	65,3	G	1,94	466	388	333	291	233	194	166	146	129			
			5	72,5	G	2,04	490	408	350	306	245	204	175	153	136			
8261013	8259496	EZK 110/05	6	87	M	2,23	535	446	382	335	268	223	191	167	149			
			1	14,5	EG	1,14	274	228	195	171	137	114	98	86	76			
			1,5	21,8	EG	1,39	334	278	238	209	167	139	119	104	93			
			2	30	MG	1,61	386	322	276	242	193	161	138	121	107			
			2,5	36,3	MG	1,80	432	360	309	270	216	180	154	135	120			
			3	43,5	MG	1,97	473	394	338	296	236	197	169	148	131			
			3,5	50,8	G	2,13	511	426	365	320	256	213	183	160	142			
			4	58	G	2,28	547	456	391	342	274	228	195	171	152			
			4,5	65,3	G	2,42	581	484	415	363	290	242	207	182	161			
8261014	8259557	EZK 110/06	5	72,5	G	2,55	612	510	437	383	306	255	219	191	170			
			6	87	M	2,79	670	558	478	419	335	279	239	209	186			
			2	30	EG	1,93	463	386	331	290	232	193	165	145	129			
			3	43,5	EG	2,36	566	472	405	354	283	236	202	177	157			
			4	58	MG	2,73	655	546	468	410	328	273	234	205	182			
			5	72,5	MG	3,05	732	610	523	458	366	305	261	229	203			
			6	87	MG	3,34	802	668	573	501	401	334	286	251	223			
			7	101,5	M	3,61	866	722	619	542	433	361	309	271	241			
			8	116	M	3,86	926	772	662	579	463	386	331	290	257			
8261015	8259558	EZK 110/08	2	30	MG	2,58	619	516	442	387	310	258	221	194	172			
			3	43,5	MG	3,16	758	632	542	474	379	316	271	237	211			
			4	58	G	3,65	876	730	626	548	438	365	313	274	243			
			5	72,5	G	4,08	979	816	699	612	490	408	350	306	272			
			6	87	G	4,47	1073	894	766	671	536	447	383	335	298			
			7	101,5	M	4,83	1159	966	828	725	580	483	414	362	322			
			8	116	M	5,16	1238	1032	885	774	619	516	442	387	344			

OPTIONALS



Pag. 293



Pag. 254-255

8253000	red
8253001	yellow
8253002	green
8253003	blue
8253041	white
8253042	orange
8253043	brown
8253048	black
8253118	grey
8253119	violet

EZK TWIN



PLASTIC (POM)



SERIE EZK-TWIN

Ugelli per uso a pieno campo a induzione d'aria

Caratteristiche

- Getto piatto con aspirazione d'aria, decentrato, usato in punta di barra;
- Angolo di spruzzo: 110°
- Pressione consigliata 1 a 6 bar;
- Usato in applicazioni a banda stretta o altre complementari con barra quali ad esempio fertilizzanti liquidi.

EZK-TWIN SERIES

Air induction nozzles for full-field use

Features

- Flat, offset air induction jet used on the boom tip;
- Spray angle: 110°
- Pressure recommended ranges from 1 to 6 bar;
- Used for narrow strip applications or other accessories with boom, such as, for example liquid fertilisers.

СЕРИЯ EZK-TWIN

Форсунки для полевых опрыскивателей с подачей воздуха

Характеристики

- Плоская струя с всасыванием воздуха, смещенная, используется на концах штанг.
- Угол распыления: 110°
- Рекомендуемое давление от 1 до 6 бар.
- Используются в узком диапазоне или в качестве комплектующей штанг, например, с жидкими удобрениями.



Part No.	Part No.	Type	NOZZLE SPACING 0,50 m - SPRAYING VOLUME (l/ha)																		
			bar	psi	l/min	5 Km/h	6 Km/h	7 Km/h	8 Km/h	10 Km/h	12 Km/h	14 Km/h	16 Km/h	18 Km/h							
8261016	8259503	EZK TWIN 110/02	1,5	21,8	0.56	134	112	96	84	67	56	48	42	37							
			2	30	0.65	156	130	111	98	78	65	56	49	43							
			2,5	36,3	0.73	175	146	125	110	88	73	63	55	49							
			3	43,5	0.80	192	160	137	120	96	80	69	60	53							
			3,5	50,8	0.86	206	172	147	129	103	86	74	65	57							
			4	58	0.92	221	184	158	138	110	92	79	69	61							
8261017	8259504	EZK TWIN 110/025	4,5	65,3	0.98	235	196	168	147	118	98	84	74	65							
			5	72,5	1.03	247	206	177	155	124	103	88	77	69							
			6	87	1.13	271	226	194	170	136	113	97	85	75							
			1,5	21,8	0.70	168	140	120	105	84	70	60	53	47							
			2	30	0.81	194	162	139	122	97	81	69	61	54							
			2,5	36,3	0.91	218	182	156	137	109	91	78	68	61							
8261018	8259505	EZK TWIN 110/03	3	43,5	0.99	238	198	170	149	119	99	85	74	66							
			3,5	50,8	1.07	257	214	183	161	128	107	92	80	71							
			4	58	1.15	276	230	197	173	138	115	99	86	77							
			4,5	65,3	1.22	293	244	209	183	146	122	105	92	81							
			5	72,5	1.28	307	256	219	192	154	128	110	96	85							
			6	87	1.40	336	280	240	210	168	140	120	105	93							
8261019	8259506	EZK TWIN 110/04	1,5	21,8	0.84	202	168	144	126	101	84	72	63	56							
			2	30	0.97	233	194	166	146	116	97	83	73	65							
			2,5	36,3	1.08	259	216	185	162	130	108	93	81	72							
			3	43,5	1.19	286	238	204	179	143	119	102	89	79							
			3,5	50,8	1.28	307	256	219	192	154	128	110	96	85							
			4	58	1.37	329	274	235	206	164	137	117	103	91							
8261055	8259580	EZK TWIN 110/05	4,5	65,3	1.46	350	292	250	219	175	146	125	110	97							
			5	72,5	1.53	367	306	262	230	184	153	131	115	102							
			6	87	1.68	403	336	288	252	202	168	144	126	112							
			1	14,5	0.91	218	182	156	137	109	91	78	68	61							
			1,5	21,8	1.12	269	224	192	168	134	112	96	84	75							
			2	30	1.29	310	258	221	194	155	129	111	97	86							
8261056	8259581	EZK TWIN 110/06	2,5	36,3	1.44	346	288	247	216	173	144	123	108	96							
			3	43,5	1.58	379	316	271	237	190	158	135	119	105							
			3,5	50,8	1.71	410	342	293	257	205	171	147	128	114							
			4	58	1.82	437	364	312	273	218	182	156	137	121							
			4,5	65,3	1.94	466	388	333	291	233	194	166	146	129							
			5	72,5	2.04	490	408	350	306	245	204	175	153	136							
8253000	8253001	8253002	8253003	8253004	8253042	8253043	8253048	8253118	8253119	6	87	2.23	535	446	382	335	268	223	191	167	149
										1	14,5	1.14	274	228	195	171	137	114	98	86	76
										1,5	21,8	1.39	334	278	238	209	167	139	119	104	93
										2	30	1.61	386	322	276	242	193	161	138	121	107
										2,5	36,3	1.80	432	360	309	270	216	180	154	135	120
										3	43,5	1.97	473	394	338	296	236	197	169	148	131
8253002	8253003	8253004	8253041	8253042	8253043	8253048	8253118	8253119	3,5	50,8	2.13	511	426	365	320	256	213	183	160	142	
									4	58	2.28	547	456	391	342	274	228	195	171	152	
									4,5	65,3	2.42	581	484	415	363	290	242	207	182	161	
									5	72,5	2.55	612	510	437	383	306	255	219	191	170	
									6	87	2.79	670	558	478	419	335	279	239	209	186	
									2	30	1.93	463	386	331	290	232	193	165	145	129	
3	43,5	2.36	566	472	405	354	283	236	202	177	157										
4	58	2.73	655	546	468	410	328	273	234	205	182										
5	72,5	3.05	732	610	523	458	366	305	261	229	203										
6	87	3.34	802	668	573	501	401	334	286	251	223										
7	101,5	3.61	866	722	619	542	433	361	309	271	241										
8	116	3.86	926	772	662	579	463	386	331	290	257										

OPTIONALS



Pag. 293



Pag. 254-255

8253000	red
8253001	yellow
8253002	green
8253003	blue
8253041	white
8253042	orange
8253043	brown
8253048	black
8253118	grey
8253119	violet

RS



PLASTIC (POM)

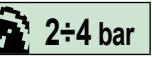

2÷4 bar

SERIE RS - Ugelli per uso a pieno campo senza induzione d'aria

Caratteristiche

- Realizzati in resina acetilica
- Pressione consigliata da 2 a 4 bar
- Angolo di 80° o 110°;
- Indicato per erbicidi, insetticidi e fungicidi.

RS SERIES - Nozzles for full-field use without air induction

Features

- Made in acetal resin;
- Pressure recommended ranges from 2 to 4 bar;
- 80° or 110° angle;
- Suitable for herbicides, insecticides and fungicides.

СЕРИЯ RS - Форсунки для полевых опрыскивателей без подачи воздуха

Характеристики

- Из ацетальной смолы
- Рекомендуемое давление от 2 до 4 бар.
- Угол от 80° до 110°.
- Предусмотрены для гербицидов, инсектицидов и фунгицидов.

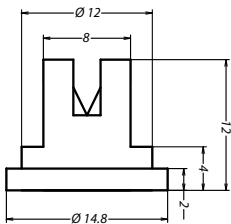

← 0,50 m →
SPRAYING VOLUME (l/ha)

Part No.	Part No.	Type	bar		VMD	SPRAYING VOLUME (l/ha)													
			psi			l/min	4 Km/h	5 Km/h	6 Km/h	7 Km/h	8 Km/h	9 Km/h	10 Km/h	12 Km/h	14 Km/h	16 Km/h	18 Km/h	20 Km/h	25 Km/h
8261020 8261021	8259507 8259521	110-01 80-01	2	30	F	0,32	96	76,8	64	54,9	48	38,4	32	24	21,3	19,2	15,4	12,8	11
			2,5	36	F	0,36	108	86,4	72	61,7	54	43,2	36	27	24	21,6	17,3	14,4	12,3
			3	43	F	0,39	117	93,6	78	66,9	58,5	46,8	39	29,3	26	23,4	18,7	15,6	13,4
			3,5	5,1	F	0,42	126	101	84	72	63	50,4	42	31,5	28	25,2	20,2	16,8	14,4
8261022 8261023	8259508 8259522	110-015 80-015	2	30	F	0,48	144	115	96	82,3	72	57,6	48	36	32	28,8	23	19,2	16,5
			2,5	36	F	0,54	162	130	108	92,6	81	64,8	54	40,5	36	32,4	25,9	21,6	18,5
			3	43	F	0,59	177	142	118	101	88,5	70,8	59	44,3	39,3	35,4	28,3	23,6	20,2
			3,5	5,1	F	0,64	192	154	128	110	96	76,8	64	48	42,7	38,4	30,7	25,6	21,9
8261024 8261025	8259509 8259523	110-02 80-02	2	30	F	0,65	195	156	130	111	97,5	78	65	48,8	43,3	39	31,2	26	22,3
			2,5	36	F	0,72	216	173	144	123	108	86,4	72	54	48	43,2	34,6	28,8	24,7
			3	43	F	0,79	237	190	158	135	119	94,8	79	59,3	52,7	47,4	37,9	31,6	27,1
			3,5	5,1	F	0,85	255	204	170	146	128	102	85	63,8	56,7	51	40,8	34	29,1
8261026 8261027	8259510 8259524	110-03 80-03	2	30	F	0,96	288	230	192	165	144	115	96	72	64	57,6	46,1	38,4	32,9
			2,5	36	F	1,08	324	259	216	185	162	130	108	81	72	64,8	51,8	43,2	37
			3	43	F	1,18	354	283	236	202	177	142	118	88,5	78	70,8	56,6	47,2	40,5
			3,5	5,1	F	1,27	381	305	254	218	191	152	127	95,3	84,7	76,2	61	50,8	43,5
8261028 8261029	8259511 8259525	110-04 80-04	2	30	F	1,29	387	310	258	221	194	155	129	96,8	86	77,4	61,9	51,6	44,2
			2,5	36	F	1,44	432	346	288	247	216	173	144	108	96	86,4	69,1	57,6	49,4
			3	43	F	1,58	474	379	316	271	237	190	158	119	105	94,8	75,8	63,2	54,2
			3,5	5,1	F	1,71	513	410	342	293	257	205	171	128	114	103	82,1	68,4	58,6
8261030 8261031	8259512 8259526	110-05 80-05	2	30	M	1,61	483	386	322	276	242	193	161	121	107	96,6	77,3	64,4	55,2
			2,5	36	M	1,8	540	432	360	309	270	216	180	135	120	108	86,4	72	61,7
			3	43	M	1,97	591	473	394	338	296	236	197	148	131	118	94,6	78,8	67,5
			3,5	5,1	M	2,13	639	511	426	365	320	256	213	160	142	128	102	85,2	73
8261032 8261033	8259513 8259527	110-06 80-06	2	30	M	1,94	582	466	388	333	291	233	194	146	129	116	93,1	77,6	66,5
			2,5	36	M	2,16	648	518	432	370	324	259	216	162	144	130	104	86,4	74,1
			3	43	M	2,37	711	569	474	406	356	284	237	178	158	142	114	94,8	81,3
			3,5	5,1	M	2,56	768	614	512	439	384	307	256	192	171	154	123	102	87,8
8261034 8261035	8259548 8259549	110-08 80-08	2	30	G	2,58	774	619	516	442	387	310	258	194	172	155	124	103	88,5
			2,5	36	G	2,88	864	691	576	494	432	346	288	216	192	173	138	115	98,7
			3	43	G	3,16	948	758	632	542	474	379	316	237	211	190	152	126	108
			3,5	5,1	M	3,41	1023	818	682	585	512	409	341	256	227	205	164	136	117
8261036 8261037	8259550 8259551	110-10 80-10	2	30	G	3,23	969	775	646	554	485	388	323	242	215	194	155	129	111
			3	43	G	3,95	1185	948	790	677	593	474	395	296	263	237	190	158	135
			4	58	G	4,56	1368	1094	912	782	684	547	456	342	304	274	219	182	156
			2	30	G	4,83	1449	1159	966	828	725	580	483	362	322	290	232	193	166
8261038 8261039	8259552 8259553	110-15 80-15	3	43	G	5,92	1776	1421	1184	1015	888	710	592	444	395	355	284	237	203
			4	58	G	6,84	2052	1642	1368	1173	1026	821	684	513	456	410	328	274	235
			2	30	G	6,44	1932	1546	1288	1104	966	773	644	483	429	386	309	258	221
			3	43	G	7,89	2367	1894	1578	1353	1184	947	788	592	526	473	379	316	271
8261040	8259554	110-20	4	58	G	9,11	2733	2186	1822	1562	1367	1093	911	683	607	547	437	364	312

OPTIONALS

Pag. 293

Pag. 254-255

8253000	red
8253001	yellow
8253002	green
8253003	blue
8253041	white
8253042	orange
8253043	brown
8253048	black
8253118	grey
8253119	violet

KR5



PLASTIC (POM)



SERIE KR5

Caratteristiche

- Ugello a spruzzo piatto
 - Angolo di spruzzo: 60°
 - Pressione consigliata 2 a 5 bar
 - Potenziale di deriva estremamente basso ed effetto di riduzione delle perdite nell'intervallo di pressione fino a 3,0 bar.
- I valori specificati in tabella si ritengono validi per una concentrazione di prodotto al 32%.

KR5 SERIES

Features

- Flat-spray tip
 - Spray angle: 60°
 - Pressure recommended ranges from 2 to 5 bar
 - Extremely low drift potential and loss-reducing effect in pressure range up to 3.0 bar.
- The indicated values in chart are valid for a product concentration of 32%.

СЕРИЯ KR5

Характеристики:

- Плоская струя
 - Угол распыления: 60°
 - Рекомендуемое давление от 2 до 5 бар
 - Крайне низкая вероятность сноса ветром и эффект снижения потерь при давлении до 3.0 бар
- Указанные в таблице значения действуют при концентрации средств в 32%.

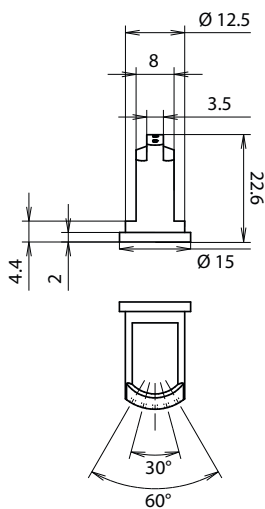

← 0,50 m →
NOZZLE SPACING 0,50 m - SPRAYING VOLUME (l/ha)

Part No.	Type	bar	psi	l/min	6 Km/h	7 Km/h	8 Km/h	10 Km/h
8259572	KR5 60/02	2	30	0.65	113	97	85	68
		3	43,5	0.80	139	119	104	83
		4	58	0.92	160	137	120	96
		5	72,5	1.03	179	153	134	106
8259573	KR5 60/025	2	30	0.81	141	120	106	84
		3	43,5	0.99	172	148	130	103
		4	58	1.15	200	171	150	120
		5	72,5	1.28	222	190	167	134
8259574	KR5 60/03	2	30	0.97	163	144	122	94
		3	43,5	1.19	205	177	153	123
		4	58	1.37	234	204	176	140
		5	72,5	1.53	262	227	197	157
8259575	KR5 60/04	2	30	1.29	221	192	166	132
		3	43,5	1.58	276	235	208	166
		4	58	1.82	307	271	231	184
		5	72,5	2.04	351	304	263	210
8259576	KR5 60/05	2	30	1.61	271	240	206	165
		3	43,5	1.97	339	294	254	203
		4	58	2.28	387	340	291	233
		5	72,5	2.55	438	380	328	262
8259577	KR5 60/06	2	30	1.93	334	289	250	200
		3	43,5	2.36	410	353	308	246
		4	58	2.73	480	409	360	288
		5	72,5	3.05	530	456	398	318
8259578	KR5 60/08	2	30	2.58	449	384	337	269
		3	43,5	3.16	550	471	412	329
		4	58	3.65	635	544	476	381
		5	72,5	4.08	710	608	532	426

OPTIONALS



Pag. 293

Pag. 254-255

8253000	red
8253001	yellow
8253002	green
8253003	blue
8253041	white
8253042	orange
8253043	brown
8253048	black
8253118	grey
8253119	violet



Ugello in ottone a ventaglio 110°

Brass flat nozzles 110°

Веерная латунная форсунка с углом разбрызгивания 110°



Part No.	Ø mm	Portata (l/min) - Flow rate													Pack		
		0,5 bar	0,7 bar	1 bar	1,5 bar	2 bar	3 bar	4 bar	5 bar	6 bar	7 bar	10 bar	15 bar	20 bar		35 bar	
01	8259134	0,66	0,15	0,18	0,23	0,27	0,32	0,39	0,46	0,5	0,55	0,6	0,7	0,9	1	1,3	25
015	8259135	0,79	0,24	0,3	0,34	0,43	0,48	0,59	0,58	0,76	0,83	0,9	1,1	1,3	1,5	2	
02	8259136	0,91	0,31	0,38	0,45	0,55	0,64	0,78	0,9	1	1,1	1,2	1,5	1,8	2	2,7	
03	8259137	1,1	0,48	0,55	0,68	0,85	0,96	1,2	1,36	1,5	1,7	1,8	2,1	2,6	3	4	
04	8259138	1,3	0,64	0,75	0,9	1,1	1,3	1,6	1,8	2	2,2	2,4	2,9	3,5	4	5,3	

Ugello in ottone a ventaglio eccentrico

Off-centre brass flat nozzles

Латунная форсунка с эксц.углом разбрызг.



Nozzle mm	Part No.	bar	l/min'	L (cm)	H = 45 cm			L (cm)	H = 60 cm			Pack
					l/ha in Km / h	5	6		8	l/ha in Km / h	5	
Ø 0,91	8259139	2	0,65	170	45	37	28	190	41	34	25	25
		3	0,79	175	54	45	33	195	49	40	30	
		4	0,91	180	60	50	38	198	55	46	35	
Ø 1,09	8259140	2	0,97	195	59	50	37	205	57	48	36	
		3	1,18	200	70	58	44	210	68	56	42	
		4	1,37	208	79	66	49	215	76	64	48	
Ø 1,32	8259141	2	1,29	230	67	56	42	235	66	55	41	
		3	1,58	235	80	67	50	238	80	66	50	
		4	1,82	238	92	77	57	240	91	76	57	
Ø 1,57	8259142	2	1,93	250	92	77	58	274	85	71	53	
		3	2,37	255	111	93	69	280	102	85	64	
		4	2,74	260	127	106	79	282	117	97	73	
Ø 1,83	8259180	2	2,58	254	122	102	76,2	279	111	92,5	69,4	
		3	3,16	259	146	122	91,5	284	133	111	83,5	
		4	3,65	264	166	138	104	287	153	127	95,4	

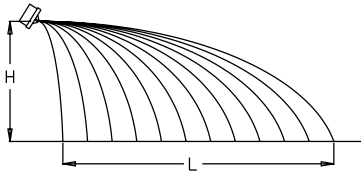

Piastrina in acciaio inox a cono ø 15 mm
Stainless steel disc cone ø 15 mm
Пластина из нерж.стали с конусом ø 15 мм



Part No.	Ø mm	Pack
8259143	1	100
8259144	1,2	
8259145	1,5	
8259146	1,8	
8259147	2	

Convogliatore in acciaio inox ø 15 mm
Stainless steel core ø 15 mm
Направляющее устройство из нерж.стали ø 15 мм



Part No.	Ø mm	Pack
8259148	blank	100
8259237	1,2	
8259337	1,5	
8259338	1,8	

Guarnizione per piastrina inox ø 15 mm
Gasket for s/s core ø 15 mm
Прокладка для пластинки из нерж.стали ø 15 мм



Part No.	Pack
G00002032	100

Piastrina in ceramica ø 15 mm
Ceramic disc ø 15 mm
Керамическая пластинка ø 15 мм



Part No.	Ø mm	Pack
8259167	0,8	100
8259168	1,0	
8259169	1,2	
8259170	1,5	
8259171	1,8	
8259172	2,0	



FILTERS

Filtri per ugelli

Nozzle filters

Фильтры для форсунок

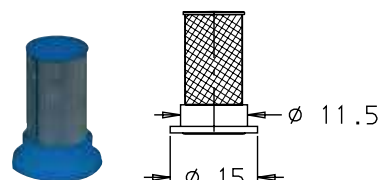
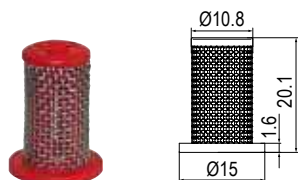

Part No.	Screen MESH	Pack
8139017	30 MESH	10
8139018	50 MESH	
8139019	80 MESH	
8139020	100 MESH	
8139021	120 MESH	

PACK



Clamshell
PCS 10

Part No.	Screen MESH	Pack
8139002	50 MESH	50
8139003	100 MESH	

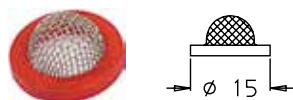

Part No.	Screen MESH	Pack
8139000	32 MESH	50
8139001	50 MESH	
8139016	100 MESH	

Part No.	Screen MESH	Pack
8139022	25 MESH	50
8139023	50 MESH	50
8139024	80 MESH	50

Filtri per ugelli con antigoccia a sfera

Nozzle filters with ball check-valve

Фильтры для форсунок с шар.обр.клапаном

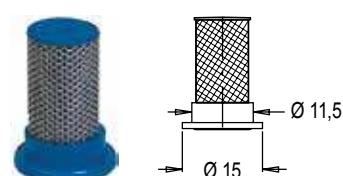
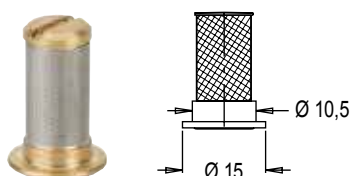

Part No.	Screen MESH	Pack
8139009	50 MESH	50
8139010	100 MESH	

Part No.	Screen MESH	Pack
8139004	50 MESH	50
8139005	100 MESH	
8139013	200 MESH	

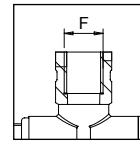
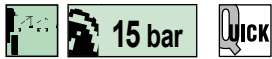

Part No.	F	Pack
8247011	G 1/4" F	
8247012	NPT 1/4" F	25
8247013	G 3/8" F	

Portaugello snodato femmina - attacco rapido.
 Swivel female nozzle holder - quick-fitting.
 Шарнирный форсункодержатель с внутренней резьбой - с фитингом быстрого подключения.

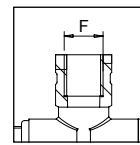

Part No.	F	Pack
8247017	G 1/4" F	
8247018	NPT 1/4" F	25
8247019	G 3/8" F	

Portaugello snodato femmina - girello G 3/8".
 Swivel female nozzle holder - BSP 3/8" fly nut.
 Шарнирный форсункодержатель с внутренней резьбой - барашковая гайка G 3/8".

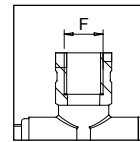

Part No.	F	Pack
8247014	G 1/4" F	
8247015	NPT 1/4" F	25
8247016	G 3/8" F	

Portaugello snodato doppio femmina - attacco rapido.
 Double swivel female nozzle holder - quick-fitting.
 Двойной шарнирный форсункодержатель с внутренней резьбой - с фитингом быстрого подключения.

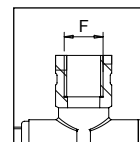

Part No.	F	Pack
8247020	G 1/4" F	
8247021	NPT 1/4" F	25
8247022	G 3/8" F	

Portaugello snodato doppio femmina - girello G 3/8".
 Double swivel female nozzle holder - BSP 3/8" fly nut.
 Двойной шарнирный форсункодержатель с внутренней резьбой - барашковая гайка G 3/8".

Portaugelli snodati in ottone nichelato per barre interfilari e per uso industriale. Tenute in NBR. Ugelli non compresi.

Brass galvanised swivel nozzle holders for interline booms and industrial applications. NBR gaskets. Nozzles not included.

Шарнирные форсункодержатели из никелированной латуни для межрядовых штанг. Уплотнения из NBR. Форсунки не включены в комплектацию.



Portaugello snodato maschio con girello G3/8".
Swivel male nozzle holder with 3/8" fly nut.
Шарнирный форсункодержатель с наружной резьбой с барашковой гайкой G 3/8".



Part No.	F2	Pack
8247003	G 1/4" M	10



Portaugello snodato femmina con girello 3/8".
Swivel female nozzle holder with BSP 3/8" fly nut.
Шарнирный форсункодержатель с внутренней резьбой с барашковой гайкой G 3/8".



Part No.	F	Pack
8247004	G 1/4" F	
8247005	NPT 1/4" F	10
8247006	Ø12x19 F	



Portaugello snodato doppio maschio con girelli G3/8".
Double swivel male nozzle holders with fly nuts BSP 3/8".
Двойной шарнирный форсункодержатель с наружной резьбой с барашковыми гайками G 3/8".



Part No.	F	Pack
8247007	G 1/4" M	10



Portaugello doppio femmina con girelli G3/8".
Double swivel female nozzle holder with fly nuts BSP 3/8".
Двойной форсункодержатель с внутренней резьбой с барашковыми гайками G 3/8".



Part No.	F	Pack
8247008	G 1/4" F	
8247009	NPT 1/4" F	10
8247010	Ø12x19 F	

SPARE PARTS



Part No.	for NOZZLE	Pack
8304026	ATR/TR	10

OPTIONALS



Pag. 262-290

Portaugello fisso completo di o-ring di tenuta e girello 3/8". Per tubi Ø 20mm (1/2").

Fixed nozzle holder with o-ring gasket and 3/8" fly nut. For rods of Ø 20mm (1/2").

Фиксированный форсункодержатель с уплотнительным кольцом и барашковой гайкой 3/8". Для труб Ø 20мм (1/2").



Part No.	F mm	D mm	Pack
8272004	7	20 (1/2")	25

DIMENSIONS

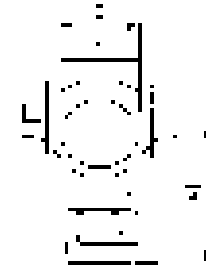

SPARE PARTS



Part No.	for NOZZLE	Pack
8304026	ATR/TR	10

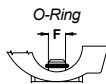

Part No.	F mm	Pack
G00001006	7	50

OPTIONALS



Pag. 262-290

Portaugello fisso con cavallotto filettato, o-ring di tenuta e girello 3/8". Per tubi Ø 20 mm (1/2").

Fixed nozzle holder with o-ring gasket and 3/8" fly nut. Mounting hole of M8. For rods of Ø 20mm (1/2").

Фикс.форсункодержатель с резьб.хомутом, кольц.уплотнением и барашковой гайкой 3/8". Для труб Ø 20 мм (1/2").



Part No.	F mm	F1	D mm	Pack
8272005	7	M8	20 (1/2")	25

DIMENSIONS

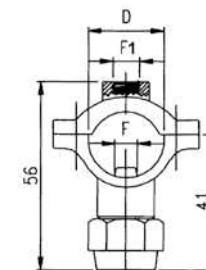

SPARE PARTS



Part No.	for NOZZLE	Pack
8304026	ATR/TR	10



Part No.	F mm	Pack
G00001006	7	50

OPTIONALS



Pag. 262-290

Portaugello fisso.

Fixed nozzle holder.

Фиксированный форсункодержатель



Part No.	F	Pack
8249000	1/8" M	25



Part No.	F	Pack
8249001	1/4" M	25

SPARE PARTS



Part No.	for NOZZLE	Pack
8304026	ATR/TR	10

OPTIONALS



Pag. 262-290

Tubi di calata.

Hose drips.

Трубки.

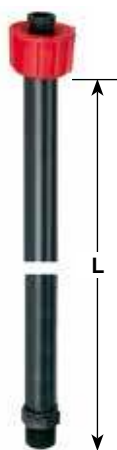

Part No.	L mm	Type	Pack
8251000	380	QUICK	10
8251001	380	G 3/8"	
8251002	610	QUICK	
8251003	610	G 3/8"	

LEGENDA

Campo di impiego / Use / Применение



Per macchine a basso volume
For low-volume spraying machines
Для малообъемных опрыскивателей



Per atomizzatori
For orchard sprayers
Для опрыскивателей



Per macchine da diserbo
For crop sprayers
Для штанговых опрыскивателей

Accessori opzionali *Optionals* Дополнительные аксессуары



Protezione per barre interfilari
Shield for interline booms
Кожух для междювых штанг



Protezione antideriva
Drift Protection
Защита от сноса



Terminale per barre interfilari
Boom end nozzle protectors
Терминальный элемент для междювых штанг

BARRE INTERFILARI

VINEYARD SPRAY BOOMS/ МЕЖРЯДОВЫЕ ШТАНГИ

6A

Barre interfilari

Struttura metallica zincata, aste portaugello in acciaio inox, cofani di protezione in PLT, getti snodati in ottone, ugelli in resina acetaleica, pistoni idraulici senza tubi di collegamento.

Vineyard spray booms

Galvanized structure, rods in stainless steel, protective cases in PLT, brass swivel nozzle bodies, acetalic resin nozzles, hydraulic pistons without connection pipes.

Межрядовые штанги

Металлическая оцинкованная структура, штанги форсункодержателей из нержавеющей стали, защитные корпуса из PLT, шарнирные форсунки из латуни, форсунки из ацетальной смолы, гидравлические поршни без соединительных труб.

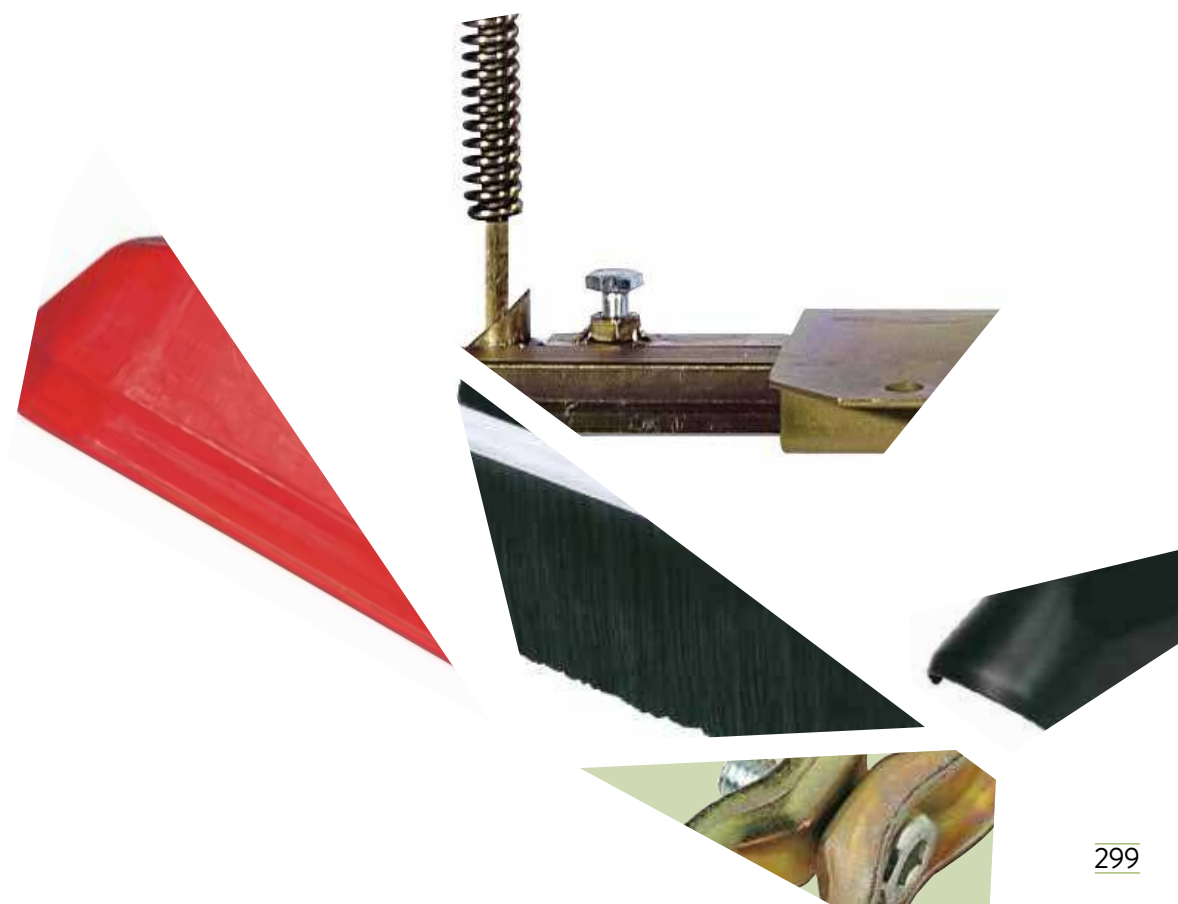

Il nuovo sistema ad innesto rapido permette di assemblare una barra da diserbo senza filettature sul tubo.

Riduce fortemente i tempi di montaggio ed offre molti vantaggi:

- Non necessita di filetti per il fissaggio;
- Disponibile per tubi da 1/2";
- Corpo in polipropilene con fibra vetro;
- O'Ring interni in EPDM.

The new quick coupling system allows assembling a spraying boom without threads on the tube.

Reduced installation time and many other advantages:

- No need for fixing threads
- Available for 1/2» tubes
- Polypropylene body with fiberglass
- Interior EPDM O'Rings

Новая система фитинга быстрого соединения позволяет устанавливать межрядовые штанги без нарезания резьбы.

Значительно сокращает время монтажа и дает следующие преимущества:

- Не нужно нарезать резьбу для крепления;
- Предназначена для труб диам.1/2";
- Фитинг выполнен из полипропилена со стекловолокном;
- Внутреннее уплотнительное кольцо выполнено из EPDM.



Raccordo ingresso a "T"

Entrance tee

Фитинг с Т-образным входом

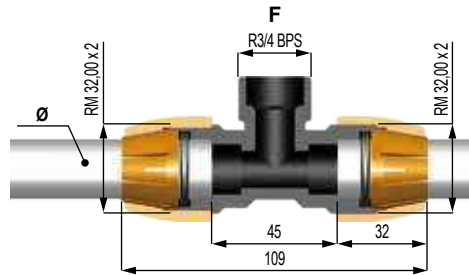

Part No.	Ø	F	Pack
8294036	1/2"	R 3/4 BPS	10
8294044	3/4"	R 3/4 BPS	10

Terminale chiuso per tubi

Closed hose terminal

Торцевая заглушка для труб

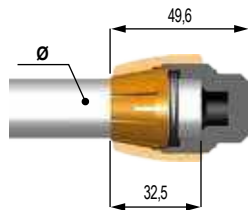

Part No.	Ø	Pack
8294037	1/2"	10

Terminale G 1/2 per tubi

G1/2 hose terminal

Торцевой наконечник G 1/2 для труб

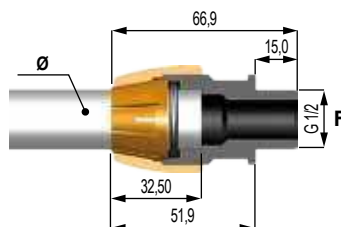

Part No.	Ø	F	Pack
8294038	1/2"	G 1/2	10
8294046	3/4"	G 1/2	10

Terminale ATRAP per tubi
Quick coupling hose terminal
Торцевой наконечник ATRAP для труб

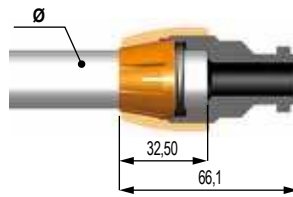

Part No.	Ø	Pack
8294039	1/2"	10

Terminale ATRAP C A/G per tubi
Quick coupling hose terminal with check-valve
Торцевой наконечник ATRAP C с клапаном A/G для труб

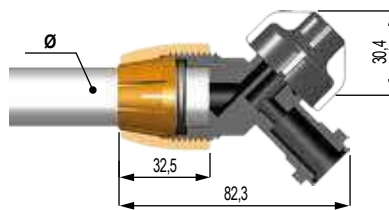

Part No.	Ø	Pack
8294040	1/2"	10

Terminale 90° G 3/4
G 3/4 90° hose terminal
Торцевой уголок 90° G 3/4

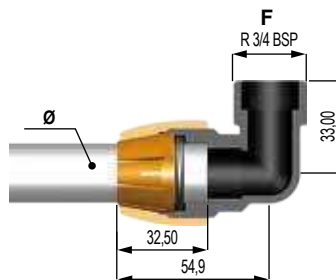

Part No.	Ø	F	Pack
8294041	1/2"	R 3/4 BPS	10

Terminale portagomma 90°
90° hoesetail terminal
Торцевой уголок 90° со штуцером

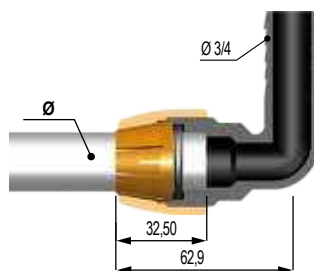

Part No.	Ø	Pack
8294042	1/2"	10

Terminale portagomma
Hoesetail terminal
Торцевой наконечник со штуцером

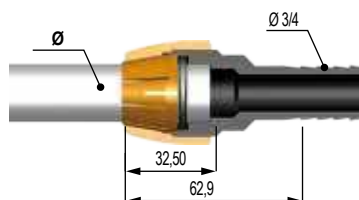

Part No.	Ø	Pack
8294043	1/2"	10
8294045	3/4"	10

Morsetto supporto barra da diserbo completo di vite e dado *Boom clamps with screw and nut*

Опорный зажим штанги опрыскивателя с винтом и гайкой

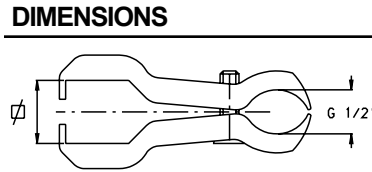

Part No.	Ø	Ø cm	Material	Pack
8294000		25	Steel	
8294001	1/2"	30	Steel	20
8294010		20	Steel	

Aste inox AISI 304 Ø 1/2" foratura 50 cm per barre da diserbo.

AISI 304 stainless steel rods, Ø 1/2" drilled at 50 cm (20 inches) for spray booms .

Стержни из нержавеющей стали AISI 304 Ø 1/2" с отверстием 50 см для штанг опрыскивателей.



DIMENSIONS

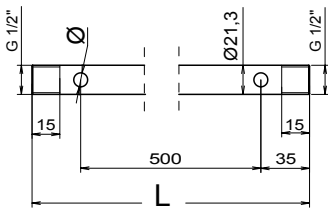

Part No.	L mm	Number of holes	Ø mm	Pack
8292103	370	1		
8292000	570	2		
8292001	1070	3		
8292002	1570	4	7	10
8292003	2070	5		
8292007	2570	6		
8292104	3070	7		
8292105	3570	8		
8292017	1070	3		
8292018	2070	5		
8292019	2570	6		
8292013	1570	4	10	10
8292169	4070	9		
8292184	3070	7		
8292278	3570	8		

Aste inox AISI 304 Ø 1/2", per barre da irrorazione.

AISI 304 stainless steel rods, Ø 1/2" for spraying booms .

Стержни из нержавеющей стали AISI 304 Ø 1/2" для штанг опрыскивателей.



DIMENSIONS

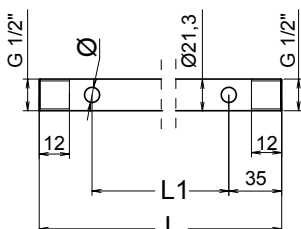

Part No.	L mm	Number of holes	L1 mm	Ø mm	Pack
8292023	800	3	360		
8292022	1000	4	310		
8292024	1000	5	230	7	10
8292025	1200	5	280		
8292026	1400	5	330		
8292027	1600	5	380		

Aste PVC Ø 1/2" foratura 50 cm per barre da diserbo.

PVC rods, Ø 1/2" drilled at 50 cm (20 inches) for spray booms.

Стержни из ПВХ Ø 1/2" с отверстием 50 см для штанг опрыскивателей.

PVC 

Part No.	L mm	Number of holes	L1 mm	Ø mm	Pack
8292324	570	2			
8292325	1070	3	500	7	10
8292326	1570	4			
8292327	2070	5			



DIMENSIONS

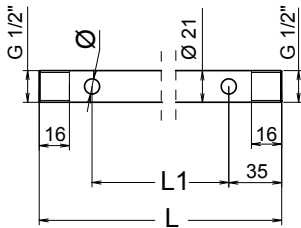

Aste curve inox AISI 304 Ø 20x1mm per gruppi ventola.
Si realizzano versioni su disegno per ogni tipo di ventola.

AISI 304 stainless steel curved rods 20x1mm for ventilating fan units.
Customized production available on request.

Изогнутые стержни из нержавеющей стали AISI 304 диам. 20x1 мм для вентиляционных блоков.

По заявке могут изготавливаться по чертежу для любых видов вентиляторов.



Part No.	ØV mm	R1 mm	Number of holes	Ø mm	Pack
8290011	600	345	6		
8290012	700	395	7		
8290013	800	445	7	7	10
8290014	900	495	7		
8290015	1000	545	7		



DIMENSIONS

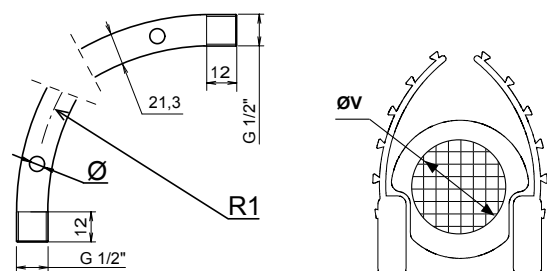

LED

Luce a doppio LED per illuminazione portageggi su barre da diserbo.

Fornita in matasse da 100 pz

LED

Dual LED Light for lighting sections.

Supplied in rolls of 100 pcs/each

СВЕТодиОД

Двойная светодиодная подсветка для освещения форсункодержателей на штангах опрыскивателей

Поставляется в мотках 100 единиц

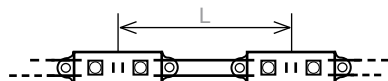

Part No.	L cm	Pack
L00500000	50	100

Reti di protezione zincate per atomizzatori

Zinc-plated protectic grid for orchard sprayers

Защитные оцинкованные сетки для распылителей

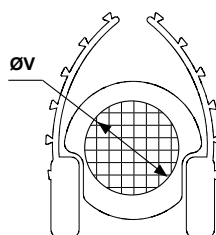
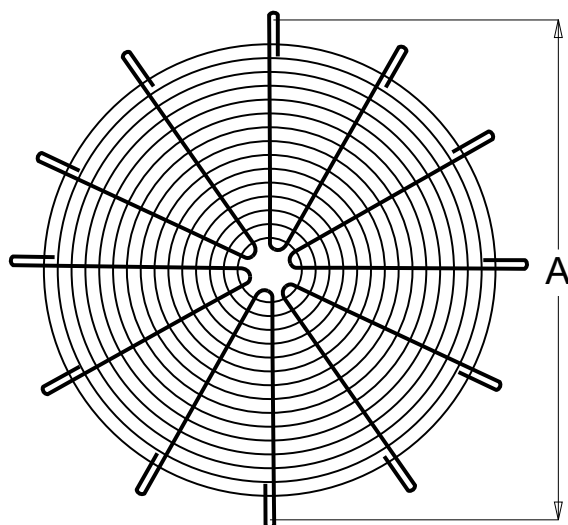

Part No.	A mm	Ø V mm	Number of hooks	Pack
8196001	780	705	12	
8196004	880	805	12	
8196007	980	905	12	
8196010	780	705	6	1
8196013	880	805	6	
8196016	980	905	6	
8196019	584	500	6	
8196022	680	600	6	

Campo di impiego / Use / Применение

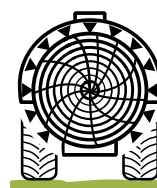

Barre interfilari meccaniche

- snodo orientabile;
- lunghezza regolabile.

Mechanical Spraying booms

- Swivel joint;
- Adjustable length.

Механические межрядовые штанги

- Поворачиваемое соединение;
- Регулируемая длина.



Part No.	Width		using cover type	Pack
	MIN	MAX		
8292251	140	180	LONG	1
	115	165	SHORT	
	95	145	MINI	

OPTIONALS

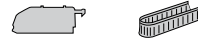

Pag. 290 Pag. 290

Barre interfilari meccaniche scoperte

- snodo orientabile
- lunghezza regolabile

Exposed mechanical Spraying booms

- Swivel joint.
- Adjustable length.

Открытые механические межрядовые штанги

- Поворачиваемое соединение.
- Регулируемая длина.

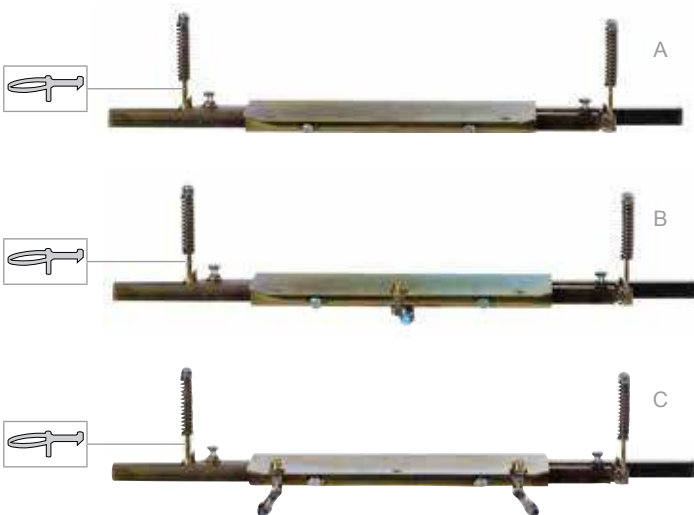

Part No.	Nozzles	Width		Pack
		MIN	MAX	
A 8292257	/	120	250	1
B 8292258	1	120	250	1
C 8292259	1 + 1	120	250	1

OPTIONALS



Pag. 290

Protezione per barre interfilari.

Shield for interline booms.

Кожух для межрядовых штанг.



Part No.	Type	L cm	W cm	H cm	Pack
C01000000	LONG	60	18,5	12,5	10

Part No.	Type	L cm	Pack
C01000001	LONG	65	1
C01000002	SHORT	48	1
C01000003	MINI	25	1



SHIELD FOR SPRAYING BOOMS

Protezione per barre interfilari
Ugelli e struttura metallica inclusi.

Shield for interline booms
Including nozzles and metal structure.

Кожух для междрядовых штанг
Форсунки и металлическая структура
включены в комплектацию.



A



B



C



Part No.	Type	L cm	Nozzles	Pack
A 8292272	LONG	65	2 x	2
B 8292273	SHORT	48	2 x	2
C 8292274	MINI	25	1 x	2

Assembly

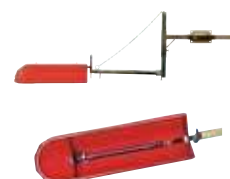

DRIFT FOR SPRAYING BOOMS

Protezione antideriva

Drift Protection

Защита от сноса



A



B



C



Part No.	Type	L cm	Pack
A P00600010	LONG	65	2
B P00600011	SHORT	48	2
C P00600012	MINI	25	2

Assembly



END FOR SPRAYING BOOMS

Terminale per barre interfilari
Ugelli inclusi.

Boom end nozzle protectors
Including nozzles.

Терминальный элемент междрядовых
штанг
Форсунки включены в комплектацию.



A



B

Part No.	Swivel nozzles	Pack
A 8292275	1 x	2
B 8292276	2 x	2

Assembly



w w w . g e o l i n e . i t



LEGENDA

Campo di impiego / Use / Применение



Per macchine a basso volume
For low-volume spraying machines
Для малообъемных опрыскивателей



Per atomizzatori
For orchard sprayers
Для опрыскивателей



Per macchine da diserbo
For crop sprayers
Для штанговых опрыскивателей

Caratteristiche / Features / Характеристики



Portata della pompa
Pump flow rate
Производительность насоса



Portata
Flow rate
Расход



Pressione d'esercizio
Operating pressure
Рабочее давление



Temperatura max
Max temperature
Максимальная температура



Peso
Weight
Вес

FEATURES



Prodotti non per uso alimentare
Products not for food use
Не годится для пищевых продуктов



Temperatura massima
Max temperature
Максимальная температура

Accessori opzionali

Optionals

Дополнительные аксессуары



Ugelli
Nozzles
Форсунки

ACCESSORI PER IRRORAZIONE 7

SPRAYER ACCESSORIES / КОМПЛЕКТУЮЩИЕ ДЛЯ РАСПЫЛИТЕЛЕЙ

Accessori per irrorazione

Gli accessori per irrorazione GEOLINE sono realizzati nei migliori materiali plastici, mentre i particolari metallici sono in acciaio inox AISI 304 o in ottone per garantire la massima affidabilità e durata.

Sprayer accessories

GEOLINE spraying accessories are made of the best quality plastic materials while the internal metal components are in stainless steel AISI 304 or brass to ensure the utmost reliability and long life.

Комплектующие для распылителей

Комплектующие для распылителей GEOLINE произведены из высококачественных пластиковых материалов, в то время как металлические детали из нержавеющей стали AISI 304 или из латуни в целях гарантии максимальной надежности и длительного срока службы.



AL 55



Pistola con lancia a getto regolabile

Gun lances with variable spray

Пистолет с регулируемой струей



Part No.	Rated Pressure bar	Permissible Pressure bar	Rated Flow l/min	IN	OUTLET	L mm	kg	Pack
4022409000	220	250	45	G 3/8 F	M15x1 F	749	1,6	5

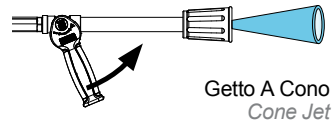
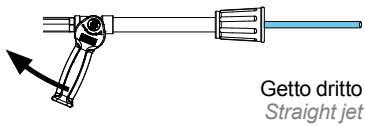

Ordinare ugello separatamente
 Nozzle to be ordered separately
 Форсунку заказывать отдельно



Pag. 313

LCX 2015



Lancia irrorazione

- costruita in ottone con tubo in acciaio inox.
- ugello standard in ceramica Ø2,3 mm.
- lunghezza totale 600 mm.
- adatta per trattamenti antiparassitari.

Spray gun

- made of brass with stainless steel tube.
- standard ceramic nozzle Ø2,3 mm.
- total length 600 mm.
- suitable for antiparasite treatments.

Пистолет-распылитель

- из латуни с трубкой из нержавеющей стали.
- стандартная керамическая форсунка Ø2,3 мм.
- общая длина 600 мм
- пригоден для антипаразитарной обработки.

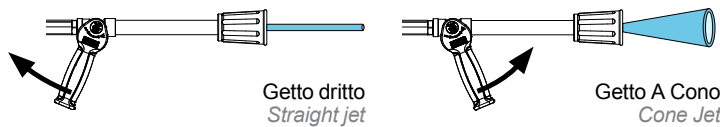

Part No.	bar		kg	Pack
8282017	50	G 1/2 M	1,6	5

SPARE PARTS

Description
Nozzle Pag. 313

LXC 2002



Lancia irrorazione

- costruita in ottone con tubo in acciaio inox.
- ugello standard in ceramica Ø2,3 mm.
- lunghezza totale 600 mm.

Spray gun

- made of brass with stainless steel tube.
- standard ceramic nozzle Ø2,3 mm.
- total length 600 mm.

Пистолет-распылитель

- из латуни с трубкой из нержавеющей стали.
- стандартная керамическая форсунка Ø2,3 мм.
- общая длина 600 мм



Part No.	bar		kg	Pack
8282012	50	G 1/2 M	1,6	5

OPTIONALS

Part No.	Description	F	Pack
8288007	Raccordo girevole 50 bar. Swivel connection 50 bar. Поворотное соединение 50 бар.	G 1/2 M - G 1/2 F	1



SPARE PARTS

Description
Nozzle Pag. 313



SLAM 907



Pistola irrorazione regolabile

- Impugnatura ergonomica in nylon® rinforzato con fibra di vetro.
- Bilanciamento dello sforzo di azionamento.
- Completa di diffusore per miscelazione d'aria regolabile. Consente una perfetta micronebulizzazione del liquido irrorato ed un basso impatto sulla coltura trattata.
- Blocco di chiusura di facile azionamento e conforme ad UNI EN 907.
- Parti interne in acciaio inox, ottone e ceramica.
- Canna in acciaio inox.
- Ugello standard in ceramica Ø1,5 mm.

- Possibilità di regolare l'ampiezza del cono di spruzzo. Reversibile anche per mancini.
- Protezione della mano inclusa.

Adjustable spraying gun

- Ergonomic nylon® handgrip, reinforced with fibreglass.
- Balancing trigger.
- Equipped with adjustable air mixing diffuser. Perfect micro spraying of the liquid and low impact on the cultivation treated.
- Handy spray lock lever and compliant with UNI EN 907.
- Inner parts made of brass, stainless steel and ceramic.
- Pipe in stainless steel.
- Equipped with standard ceramic spray tip Ø1,5 mm.

- Adjustable hollow cone spray pattern. Reversible also for left-handed users.
- Hand guard included.

Регулируемый пистолет-распылитель

- Эргономичная ручка из nylon®, усиленного стекловолокном
- Балансировка усилия воздействия.
- В комплекте с диффузором для смешивания регулируемого воздуха. Обеспечивает превосходное микрораспыление подаваемой жидкости и низкое воздействие на обрабатываемую культуру
- Защитная блокировка, соответствующая требованиям UNI EN 907.
- Внутренние детали из нержавеющей стали, латуни и керамики.
- Трубка из нержавеющей стали.
- Стандартная керамическая форсунка Ø1,5 мм.

- Возможность регулировки разбрызгивающего конуса. Реверсивный, также может использоваться левшами.
- С защитой рук.



Part No.	bar	mm	kg	Pack
8284018		1,0		
8284017		1,2		
8284011	50	1,5	G1/2 M swivel	5
8284019		2,0		
8284020		2,5		

NEW

INOX VALVE

Part No.	bar	mm	kg	Pack
8284021		1,0		
8284022		1,2		
8284023	50	1,5	G1/2 M swivel	5
8284024		2,0		
8284025		2,5		

HIGHLIGHTS

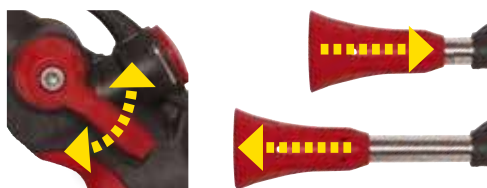

SPARE PARTS

Description

 **Nozzle** Pag. 313

NEW

 **Internal Stainless Steel valve (only for "Inox valve" version)** K00105025



NOZZLES

Ugelli di ricambio per lance

Spare nozzles for spray guns

Запасные форсунки для пистолетов-распылителей



- a cono in ceramica
 - ceramic hollow cone tip
 - керамические конусные

Part No.	Ø mm	Icon	15 bar		25 bar		35 bar		40 bar		45 bar		50 bar		Pack
			CONE	STRAIGHT	CONE	STRAIGHT	CONE	STRAIGHT	CONE	STRAIGHT	CONE	STRAIGHT	CONE	STRAIGHT	
8278000	1,0	☞ 1/1'	2,45	2,5	3,0	3,1	3,4	3,5	3,55	3,65	3,75	3,85	4,0	4,1	25
8278001	1,2	☞ 1/1'	3,6	6,8	4,25	4,6	4,7	5,4	5,2	5,9	5,35	6,1	5,6	6,3	
8278002	1,5	☞ 1/1'	4,6	5,1	5,7	6,5	6,6	7,4	6,9	7,8	7,3	8,2	7,7	8,6	
8278003	1,8	☞ 1/1'	5,9	7,3	7,2	9,3	8,5	10,8	9,2	11,7	9,7	12,2	10,5	12,7	
8278004	2,0	☞ 1/1'	6,9	8,8	8,1	11,7	10,2	13,4	10,9	14,3	11,7	15,2	12,5	15,8	
8278005	2,3	☞ 1/1'	8,1	10,8	10,2	14,1	12,9	16,8	13,7	17,9	14,3	18,8	14,9	19,7	
8278006	2,5	☞ 1/1'	9,2	13,0	11,4	16,4	14,0	19,1	14,5	21,1	15,4	22,2	16,4	23,0	
8278007	3,0	☞ 1/1'	11,5	18,4	14,4	24,1	18,0	28,2	18,8	30,1	19,6	31,5	20,9	33,0	
8278015	3,5	☞ 1/1'	14,1	21,4	18,2	27,6	21,6	32,6	23,1	34,9	24,5	37,0	25,8	39,0	
8278014	3,8	☞ 1/1'	13,9	22,5	17,9	29,1	21,2	34,4	22,6	36,8	24,0	39,0	25,3	41,1	

SUITABLE FOR



Tabella selezione ugello
 Chart nozzle selection
 Таблица подборки форсунок

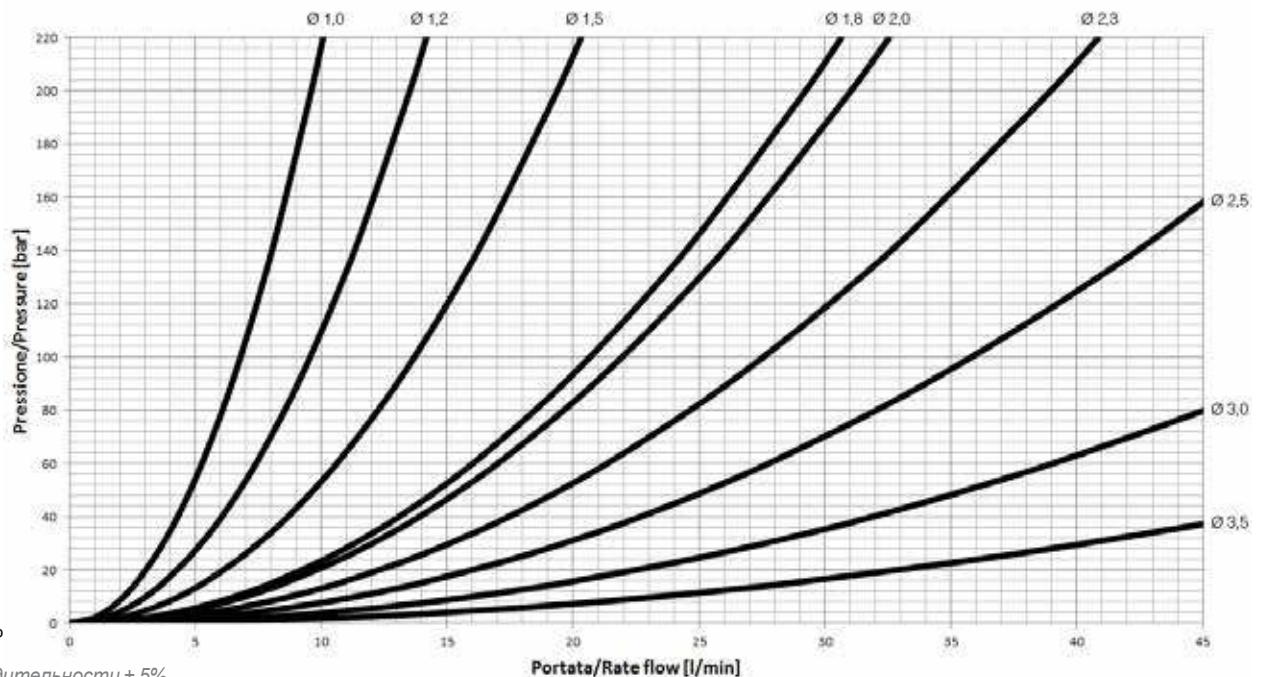

Tolleranza portata ± 5%
 Flow tolerance ± 5%
 Допуски по производительности ± 5%

SG 40-600



Pistola irrorazione regolabile

- Possibilità di regolare l'angolo di spruzzo.
- Possibilità di inserire il fermo posizione con tenuta istantanea antigoccia.
- Realizzata con materiali plastici ad alta resistenza.
- Ugello standard in ceramica.

Adjustable spraying gun

- Adjustable spray pattern.
- Stop lever with instant drip sealing.
- Made of high resistance plastic materials.
- Equipped with standard ceramic spray tip.

Регулируемый пистолет-распылитель

- Возможность регулировки угла распыления
- Возможность активации фиксатора положения с противокapelным герметичным уплотнением.
- Изготовлен из пластиковых высокопрочных материалов
- Стандартная керамическая форсунка.

Lunghezza 600 mm

Length 600 mm

Длина 600 мм



Part No.	bar	L mm	mm	mm	kg	Pack
8282013	40	600	Ø 1,5	Ø 10	1,4	5

SPARE PARTS

Part No.	Description	Hole Ø mm	Pack
8259167		0,8	
8259168	Piastrina in ceramica Ø 15 mm	1,0	100
8259169	Ceramic disc Ø 15 mm	1,2	
8259170	Керам.пластинка Ø 15 мм	1,5	
8259171		1,8	
8259172		2,0	

SG 40-300



Lunghezza 300 mm

Length 300 mm

Длина 300 мм



Part No.	bar	L mm	mm	mm	kg	Pack
8282014	40	300	Ø 1,5	Ø 10	1,0	5

SPARE PARTS

Part No.	Description	Hole Ø mm	Pack
8259167		0,8	
8259168	Piastrina in ceramica Ø 15 mm	1,0	100
8259169	Ceramic disc Ø 15 mm	1,2	
8259170	Керам.пластинка Ø 15 мм	1,5	
8259171		1,8	
8259172		2,0	

ML 310



Idropistola con tubo inox e ugello

- Scocche in plastica antiurto nere;
- Sede in plastica, sfera e tubo in acciaio inox;
- Corpo pistola in ottone stampato;
- Portagomma in ottone;
- Ugello in ottone registrabile;
- Targhette colorate.

Spray-gun pipe stainless steel and nozzle

- Anti-shock black color plastic shell;
- Plastic seat, stainless steel ball and pipe;
- Gun body in forged brass;
- Brass hose;
- Adjustable brass nozzle;
- Colored side plates.

Гидропистолет с трубой из нерж.стали и форсункой

- Черный пластиковый корпус, с эффектом поглощения гидроударов;
- Муфта гнезда из пластика, сфера и трубка из нерж.стали;
- Корпус пистолета выполнен из штампованной латуни;
- Штуцер из латуни;
- Регулируемое сопло из латуни;
- Цветные наклейки.



Part No.	bar	l/1'	°C	mm	kg	Pack
4018000130	24	25	60	Ø 10	0,533	10

SPARE PARTS

Part No.	Description	Pack
U00000134	Conejet nozzle M12-19 F	1



Part No.	bar	l/1'	°C	mm	kg	Pack
4018000157	24	25	60	G 1/2 M	0,549	10

SPARE PARTS

Part No.	Description	Pack
U00000134	Conejet nozzle M12-19 F	1



OPTIONALS



Jolly 25



Lancia serie Jolly

Elevata ergonomia e leggerezza.
 Materiali plastici PP H 30%FV.
 Materiale pistone e sfera: AISI 316.
 Materiali o-ring: Viton® o EPDM.
 Materiale sede: POM.
 Colore tappo identificativo o-ring.
 Gancio per appendere pistola.
 Corpo pistola liscio per evitare depositi di sporco, idoneo nell'industria alimentare.
 Gancio per mantenimento pistola aperta.
 Filtro ingresso e filtro ugello optional.
 Ugelli inox o POM a scelta.

Spray guns Jolly series

Great ergonomics and lightness.
 Plastic material: PP H 30%GF.
 Pin and ball material: AISI 316.
 O-ring material: Viton® or EPDM.
 Seat Material: POM.
 Plug color to identify o-ring.
 Hook to hung the gun.
 Flat body gun design to avoid dirty deposit, ideal for food industry.
 Lock system to keep opened the gun.
 Inlet/Outlet filters available as optional.
 Choice of S.Steel or POM nozzles.

Пистолет-распылитель серии Jolly

Превосходная эргономичность и легкость.
 Пластиковые материалы PP H 30% FV.
 Материал поршня и сферы: AISI 316.
 Материал кольцевого уплотнения Viton® или EPDM.
 Материал гнезда: POM.
 Цвет идентификационной пробки кольцевого уплотнения.
 Крючок для подвешивания пистолета.
 Гладкий корпус пистолета для предупреждения отложений грязи, пригоден для пищевой промышленности.
 Крючок для открытого положения пистолета.
 Входной фильтр и опциональный фильтр форсунки.
 Форсунки из нержавеющей стали или POM на выбор.

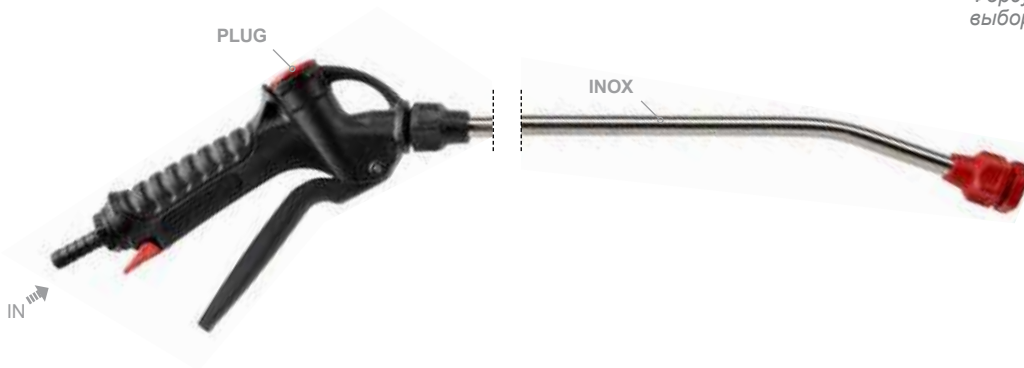

Part No.	bar	l/1'	°C	L mm	Pipe Material	mm	O-Ring	Plug Colour	kg	Pack
4020009025	15	30	50	750	Stainless Steel	Ø10	Viton®	■	0,38	10

Getto a ventaglio
 Fan jet

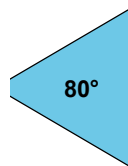

Lancia completa di: portagomma, filtro, ugello.
 Hose-tail, filter and nozzle included.
 С шлангом, фильтром, форсункой.

Jolly 25



Lancia serie Jolly

Elevata ergonomia e leggerezza.
 Materiali plastici PP H 30%FV.
 Materiale pistone e sfera: AISI 316.
 Materiali o-ring: Viton® o EPDM.
 Materiale sede: POM.
 Colore tappo identificativo o-ring.
 Gancio per appendere pistola.
 Corpo pistola liscio per evitare depositi di sporco, idoneo nell'industria alimentare.
 Gancio per mantenimento pistola aperta.
 Filtro ingresso e filtro ugello optional.
 Ugelli inox o POM a scelta.

Spray guns Jolly series

Great ergonomics and lightness.
 Plastic material: PP H 30%GF.
 Pin and ball material: AISI 316.
 O-ring material: Viton® or EPDM.
 Seat Material: POM.
 Plug color to identify o-ring.
 Hook to hung the gun.
 Flat body gun design to avoid dirty deposit, ideal for food industry.
 Lock system to keep opened the gun.
 Inlet/Outlet filters available as optional.
 Choice of S.Steel or POM nozzles.

Пистолет-распылитель серии Jolly

Превосходная эргономичность и легкость.
 Пластиковые материалы PP H 30% FV.
 Материал поршня и сферы: AISI 316.
 Материал кольцевого уплотнения Viton® или EPDM.
 Материал гнезда: POM.
 Цвет идентификационной пробки кольцевого уплотнения.
 Крючок для подвешивания пистолета.
 Гладкий корпус пистолета для предупреждения отложений грязи, пригоден для пищевой промышленности.
 Крючок для открытого положения пистолета.
 Входной фильтр и опциональный фильтр форсунки.
 Форсунки из нержавеющей стали или POM на выбор.



	Part No.	bar	l/1'	°C	mm	L mm	Plug Colour	Pipe Material	O-Ring	Nozzle	kg	Pack
A	4020009026	15	30	50	Ø10	627	■	Stainless Steel	Viton®	Blue	0,36	10
B	4020009048				Ø10	627	■	Stainless Steel	Viton®	Orange	0,36	10

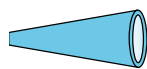

Getto a cono
Cone jet



Getto dritto
Straight jet

Lancia completa di: portagomma, filtro, ugello.
 Hose-tail, filter and nozzle included.
 С штуцером, фильтром, форсункой.

Nozzle	Jet	2 bar		3 bar		4 bar		7 bar	
		CONE	STRAIGHT	CONE	STRAIGHT	CONE	STRAIGHT	CONE	STRAIGHT
Blue	1/1'	1,7	4,4	2	5,3	2,3	6,1	3,1	8,1
	USG/1'	0,45	1,17	0,54	1,39	0,62	1,59	0,81	2,11
Orange	1/1'	0,91	3,1	1,1	3,5	1,3	4,2	1,6	5,3
	USG/1'	0,24	0,82	0,29	0,92	0,34	1,11	0,42	1,40

SPARE PARTS

Part No.	Description	Nozzle color	Material	Connection	Pack
U00000115	Ugello regolabile per pistola Jolly 25 Adjustable nozzle for Jolly 25 gun	Blue	PP	11/16" - 16	
U00000118	Регулируемая форсунка для пистолета Jolly 25	Orange	PP	11/16" - 16	

Jolly 25



Part No.	bar	l/1'	°C	O-Ring	Plug Colour	kg	Pack
4010007000	15	30	50	G 1/2 F EPDM	Blue	0,20	5
4010007001	15	30	50	G 1/2 F Viton®	Red	0,25	5



Part No.	bar	l/1'	°C	mm	O-Ring	Plug Colour	kg	Pack
4010007005	15	30	50	Ø10	EPDM	Blue	0,22	5
4010007006	15	30	50	Ø10	Viton®	Red	0,22	5

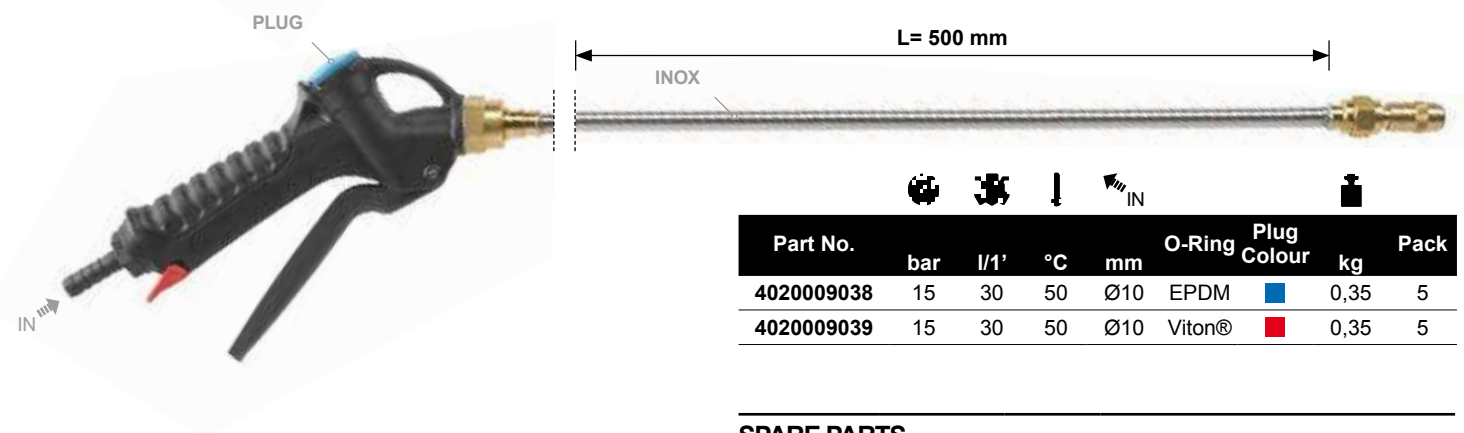

Part No.	bar	l/1'	°C	mm	O-Ring	Plug Colour	kg	Pack
4020009038	15	30	50	Ø10	EPDM	Blue	0,35	5
4020009039	15	30	50	Ø10	Viton®	Red	0,35	5

SPARE PARTS

Part No.	Description	Pack
U00000134	Conejet nozzle M12-19 F	1



Part No.	L mm	Material	Pack
8288014	500	Inox	
8288015	700	Inox	10
8288016	1000	Inox	

Prolunga per lancia
 Spray gun extension
 Удлинитель для пистолета-распылителя



Lancia con impugnatura a leva
 Handgrip spray gun
 Пистолет-распылитель с рычагом

Part No.	Pack
8280002	10



Lancia con filtro e rubinetto a sfera
 Spray gun with filter and ball cock
 Пистолет-распылитель с фильтром и шаровым краном

Part No.	Pack
8280001	10



Cartuccia ricambio per lance cod.:
 8280001 - 8280002 - 8280003
 Spare cartridge for spray guns P/N:
 8280001-8280002-8280003

Part No.	Pack
C00100045	5

Запасной патрон для распылителей
 8280001-8280002-8280003

Curva fissa M-F
 Elbow M-F
 Колено M-F

Part No.	Pack
8288004	10

Ugello registrabile Ø 1,5 mm
 Adjustable spray nozzle Ø 1,5 mm
 Регулируемая форсунка Ø 1,5 мм

Part No.	Pack
8286000	10



Ugello registrabile economico
 Adjustable nozzle
 Экономичная регулируемая форсунка

Part No.	Pack
8286003	10



Campana per diserbo localizzato
 Shield for localized weed-removal
 Колпак для локализованного распыления

Part No.	F	Pack
8292004	12x19	3
8292010	1/4"	3

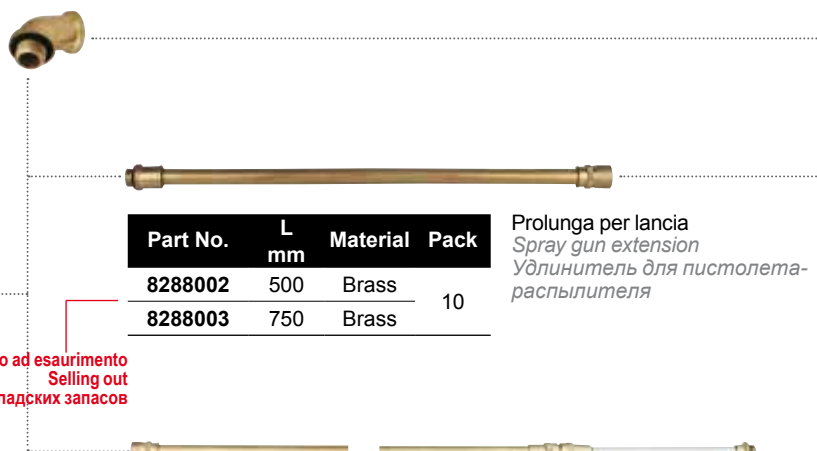

Part No.	L mm	Material	Pack
8288002	500	Brass	10
8288003	750	Brass	

Prolunga per lancia
 Spray gun extension
 Удлинитель для пистолета-распылителя

Fino ad esaurimento
 Selling out
 до окончания складских запасов

Fino ad esaurimento
 Selling out
 до окончания складских запасов

Part No.	L mm	Pack
8288009	1000	10

Prolunga per lancia telescopica
 Spray gun telescoping extension
 Удлинитель для выдвигного пистолета-распылителя

LP12



Pistola bassa pressione con getto a spillo/ a cono regolabile dalla leva e della manopola

- Leggera e semplice da usare
- Struttura interna realizzata in PP rinforzato con fibra vetro
- Giunto girevole in entrata con raccordo in acciaio inox
- Scocche in plastica morbida resistente agli urti e antimacchia
- Scocca sigillata per evitare il ristagno dello sporco
- Stelo e molla in acciaio inox
- Guarnizioni in EPDM
- Può operare a temperature e pressioni differenti per un'ampia gamma di applicazioni

- Low pressure spray gun with pencil/cone water jet adjustable from trigger and rear knob

- Lightweight and easy to use
- Internal structure made in PP reinforced with glass fiber
- Inlet swivel connection with stainless steel fitting
- Soft plastic shells at impact and stain resistant
- Sealed shells to avoid the built up of dirt
- S/S shaft and spring
- EPDM sealing
- Can operate at different temperatures and different pressures for a wide range of applications

Пистолет низкого давления, дающий конусообразную или прямую струю, регулирующуюся при помощи рычага или манжеты.

- Превосходная эргономичность и легкость.
- внутренняя конструкция выполнена из ПП, усиленного стекловолокном
- Затягивающаяся соединительная муфта с фитингом из нерж.стали
- корпус выполнен из мягкого пластика, поглощающего вибрации и устойчивого к пятнам
- корпус запаян, чтобы в пазах не собиралась грязь
- курок и пружина из нерж.стали
- уплотнения из EPDM
- может использоваться при различных температурах и под разным давлением, очень широкий диапазон применения

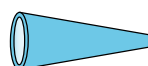

Getto a cono
Cone jet



Getto dritto
Straight jet



Part No.	bar	O-Ring	g	Pack
4010008000	12	SWIVEL G 1/2 F	EPDM 420	1

DIMENSIONS

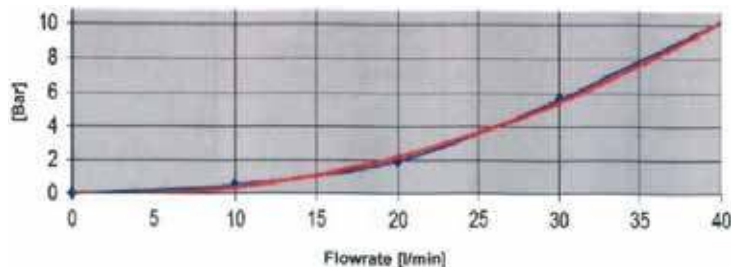
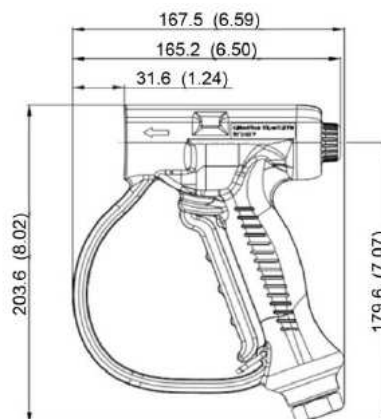

Lancia a leva

- Ugello in ceramica Ø1,5 mm con protezione
 Trigger spray gun
 - Ceramic nozzle tip Ø1,5 mm with protection
 Рычаговый пистолет-распылитель
 - Керамическая форсунка Ø1,5 мм с защитой

Part No.	bar	L mm	Pack
8282000	40	300	10
8282001	40	600	10
8282002	40	1000	10

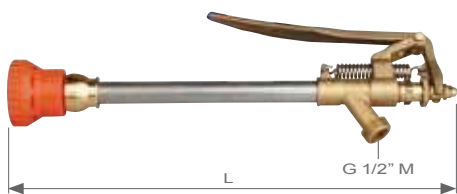

SPARE PARTS

Description		Pag.
Nozzles - Heads		321

Lancia a manopola

- Ugello in ceramica Ø1,5 mm con protezione
 Handle spray gun
 - Ceramic nozzle tip Ø1,5 mm with protection
 Пистолет-распылитель с ручкой
 - Керамическая форсунка Ø1,5 мм с защитой

Part No.	bar	L mm	Pack
8282003	40	300	10
8282004	40	600	10
8282005	40	1000	10

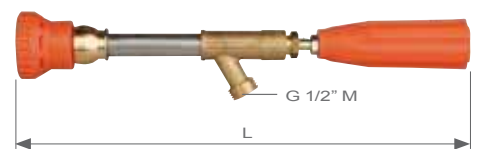

Kit testina per ugelli in ceramica (senza ugello)
 Head assembly for ceramic nozzles (nozzle not included)
 Комплект головки для керамических форсунок (без форсунки)

Part No.	Pack
8288008	10



SPARE PARTS

Part No.	Description	Pack
G00002070	Gasket	50
G00001120	O-Ring	50

Kit testina con ugello inox Ø1,5 mm
 Head assembly with inox nozzle Ø1,5 mm
 Комплект головки с форсункой из нержавеющей стали 1,5 мм

Part No.	Pack
8288005	10



OPTIONALS

Part No.	Description	Ø mm	15 bar CONE	(200 psi) STRAIGHT	30 bar CONE	(450 psi) STRAIGHT	50 bar CONE	(700 psi) STRAIGHT	Pack
8259157		1	V1'	1,8	2,3	2,6	3,2	3,4	4,1
			USG/1'	0,44	0,56	0,71	0,87	0,87	1,05
8259158	Ugelli in ceramica per getti a farfalla.	1,2	V1'	2,4	3,0	3,4	4,2	5,4	5,4
			USG/1'	0,58	0,73	0,93	1,15	1,12	1,38
8259159	Nozzles in ceramic for butterfly spray tips.	1,5	V1'	3,4	4,5	4,8	6,4	6,2	8,3
			USG/1'	0,83	1,1	1,31	1,78	1,59	2,12
8259160	Керамические форсунки для струй «бабочка».	1,8	V1'	3,9	6,9	5,5	9,8	7,1	12,7
			USG/1'	0,95	1,68	1,50	2,68	1,81	3,24
8259161		2	V1'	4,5	8,3	6,3	11,7	8,1	15,1
			USG/1'	1,1	2,0	1,73	3,2	2,1	3,85



Colonne irroranti

Column spraying booms

Колонны распылителей



Part No.	Nozzles	bar	Pack
8290005	3	50	2
8290006	4	50	

Barra a colonna
 Column spraying boom
 Колонная штанга



Part No.	Nozzles	Pack
8294007	3	5
8294008	4	

Colonna nuda
 Simple column
 Простая колонна

Portaugello ciclone con diffusore "Turbo"
 Ugello standard a cono Ø1,5 mm.

Nozzle holder with "Turbo" diffuser
 Standard hollow cone nozzle tip Ø1,5 mm.

Форсункодержатель с диффузором "Турбо"
 Стандартная конусная форсунка Ø1,5 мм.



Part No.	F	THROW		Pack	
		bar	m		
8275008	G 3/8 M	50	12	0,85	5

Getto registrabile orientabile

- Materiale: ottone;
- Guarnizioni: Viton®;
- Pressione di lavoro 40 bar;
- Permette di regolare l'angolo di spruzzo per trasformare tutti i portaugelli singoli e doppi in portaugelli con lato regolabile.

Adjustable directional jet

- Material: brass;
- Seals: Viton®;
- Working pressure 40 bar;
- Enables the spray angle to be adjusted to transform all single and double nozzle holders into adjustable nozzle holders.

- Регулируемый поворотный фитинг для направления струи.
- выполнен из латуни;
- уплотнения из Viton®;
- рабочее давление 40 Бар;
- позволяет регулировать угол подачи струи и трансформировать отдельные или двойные форсункодержатели в форсункодержатели с регулируемой струей.

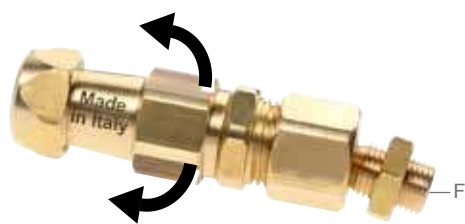

DIMENSIONS

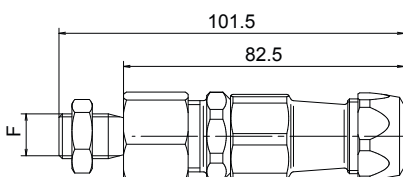

Part No.	F	DISC	Pack
8275021	G 1/4 M (BSP)	1 x Ø 15	10
8275022	G 1/4 M (BSP)	1 x Ø 18	

ASSEMBLY (Part No. 8275021)

ASSEMBLY (Part No. 8275022)

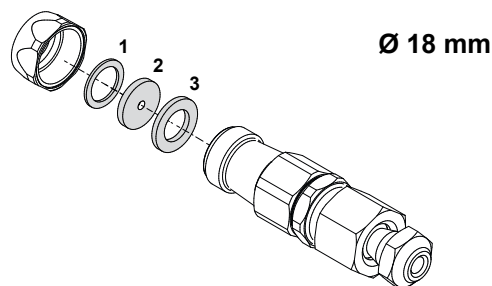
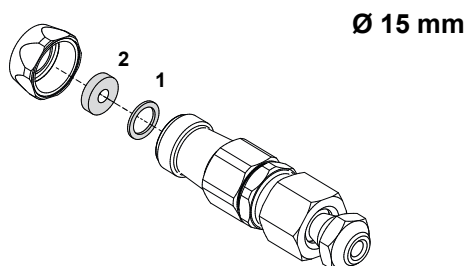

Per completare i portaugelli, ordinare piastrine e guarnizioni

To complete the nozzle holders, order plates and seals

Для полной комплектации форсункодержателей заказывать отдельно пластины и уплотнения

Ø15 mm (Pag. 333)

Ø18 mm (Pag. 334)



Nebulizzatore leggero regolabile

Adjustable bent sprayer

Легкий регулируемый распылитель

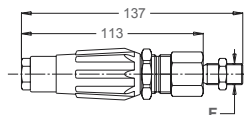
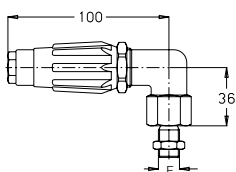

Part No.	F	mm	Nozzle Material	Pack
8275011	G 3/8 M (BSP)	1,5	Ceramic	5
8275012	G 1/4 M (BSP)	1,5		

Part No.	F	mm	Nozzle Material	Pack
8275016	G 1/4 M (BSP)	1,5	Ceramic	5
8275017	G 3/8 M (BSP)	1,5		

Fino ad esaurimento
 Selling out
 до окончания складских запасов

Snodo sferico
 Ball joint
 Шаровое соединение

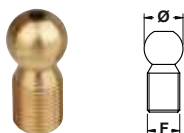

Part No.	Ø mm	F	Pack
8304014	16	G 1/4 M	10
8304017	20	G 3/8 M	

Dado
 Nut
 Гайка

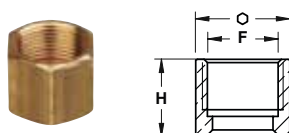

Part No.	H mm	F	Ø	Pack
8304015	16,5	G 1/4 F	19	10
8304018	20	G 3/8 F	27	

Controdado
 Locking nut
 Контргайка

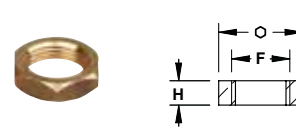

Part No.	H mm	F	Ø	Pack
8304016	5,5	G 1/4 F	19	
8304019	6,5	G 3/8 F	24	10
8304058	8,0	G 3/4 F	32	

Portaugello singolo antigoccia.
 Pressione di esercizio 30 bar.
 Utilizzo consigliato su atomizzatori e nebulizzatori a basso volume.
 Il volantino chiuso interrompe il passaggio.

Nozzle holder with diaphragm check valve
 Operating pressure: 30 bar
 Use: on low volume and orchard sprayers.
 Knob in closed position stops the flow.

Одиночный форсункодержатель с мембранным обратным клапаном.
 Рабочее давление 30 бар
 Рекомендуется использование на распылителях и малообъемных обрызгивателях.
 Закрытый маховик останавливает поток.



Part No.	IN	OUT	Type	Pack
8267007	G 1/4 F	G 1/4 F	STD	10
8267008	G 1/4 M	G 1/4 F	STD	
8267009	G 1/4 F	G 1/4 F	ON/OFF	
8267010	G 1/4 M	G 1/4 F	ON/OFF	

DIMENSIONS

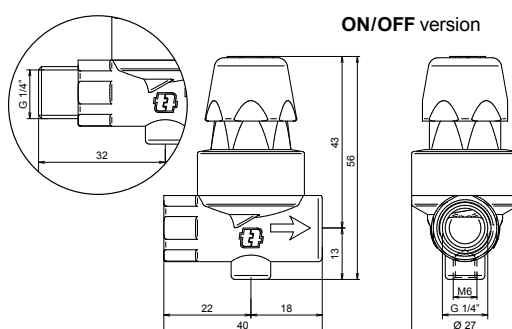
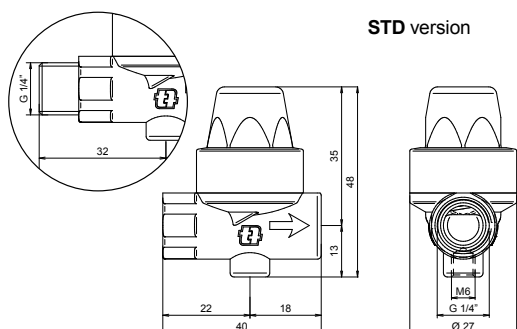

Getto regolabile fisso

- Utilizzo su macchine irroratrici e per trattamenti fito sanitari;
- Getto regolabile compatto e leggero con attacco fisso;
- Materiale: ottone;
- Guarnizioni: Viton®

Fixed adjustable jet

- For use on spraying equipment and for phytosanitary treatments;
- Compact and light adjustable jet with fixed fitting;
- Material: brass;
- Seals: Viton®

Регулируемый прямой фитинг

- применяется на поливальных машинах и при фитосанитарных обработках;
- регулируемая компактная и легкая струя;
- жесткое фиксированное крепление;
- выполнен из латуни;
- уплотнения из Viton®

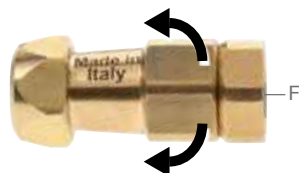

DIMENSIONS

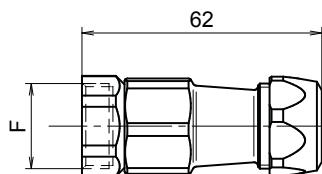

Part No.	F	DISC	Pack
8275019	M22x1,5	1 x Ø 15	10
8275020	M22x1,5	1 x Ø 18	

ASSEMBLY (Part No. 8275019)

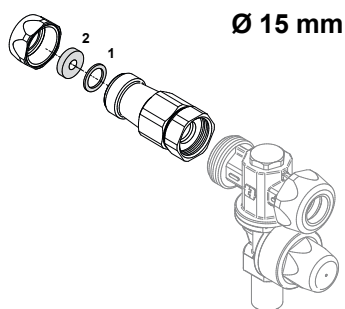

Ø 15 mm

ASSEMBLY (Part No. 8275020)

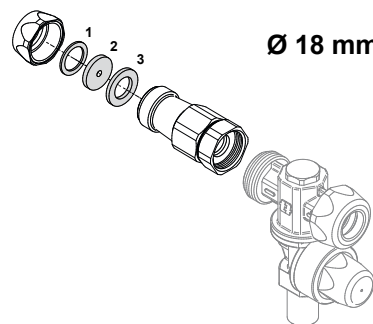

Ø 18 mm



Per completare i portaugelli, ordinare piastrine e guarnizioni

To complete the nozzle holders, order plates and seals

Для полной комплектации форсункодержателей заказывать отдельно пластины и уплотнения

Ø15 mm (Pag. 333)

Ø18 mm (Pag. 334)



Portaugello atomizzatore doppio con antigoccia e ghiera.

Double nozzle holder with diaphragm check valve and fly nuts.

Двойной форсункодержатель распылителя с обратным мембранным клапаном и барашковыми гайками.

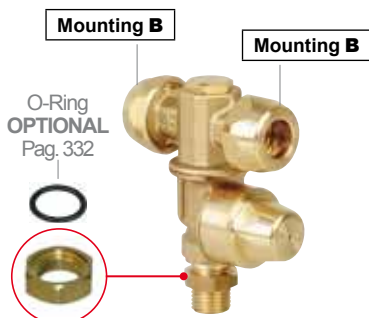

DIMENSIONS

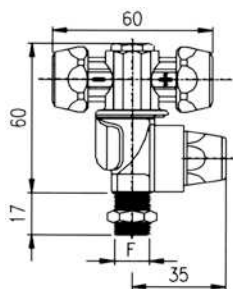

OPTIONALS

Part No.	Page
8275019	324
8275020	324



Part No.	DISC	F	Pack
8268C0002	2 x Ø15	G1/4 M	10



Per completare i portaugelli, ordinare piastrine Ø15 mm (Pag. 333)

To complete the nozzles holder, please order core Ø15 mm (Pag. 333)

Для комплектации форсункодержателей, заказать пластины Ø15 мм (Стр. 333)



Portagello atomizzatore singolo con antigoccia e ghiera

Nozzle holder with diaphragm check valve and fly nuts

Одиночный форсункодержатель распылителя с обратным мембранным клапаном и барашковыми гайками.



DIMENSIONS

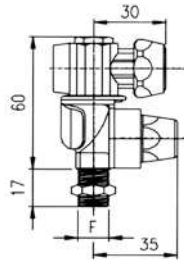

OPTIONALS

Part No.	Page
8275019	324
8275020	324



Part No.	DISC	CONE NOZZLE	F	Pack
8267000	1 x Ø18	-	G 1/4 M	10
8267001	1 x Ø18	-	G 1/4 F	
8267002	1 x Ø18	-	G 3/8 M	
8267003	-	1 x ATR/MGA	G 1/4 M	
8267004	-	1 x ATR/MGA	G 1/4 F	
8267005	-	1 x ATR/MGA	G 3/8 M	



Portagello atomizzatore doppio con antigoccia e ghiera

Double nozzle holder with diaphragm check valve and fly nuts

Двойной форсункодержатель распылителя с обратным мембранным клапаном и барашковыми гайками.



DIMENSIONS

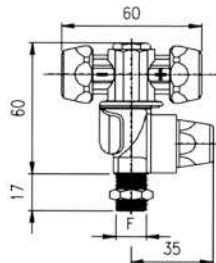

OPTIONALS

Part No.	Page
8275019	324
8275020	324



Part No.	DISC	CONE NOZZLE	F	Pack
8268000	2 x Ø18	-	G 1/4 M	10
8268001	2 x Ø18	-	G 1/4 F	
8268002	2 x Ø18	-	G 3/8 M	
8268003	1 x Ø18	1 x ATR/MGA	G 1/4 M	
8268004	1 x Ø18	1 x ATR/MGA	G 1/4 F	
8268005	1 x Ø18	1 x ATR/MGA	G 3/8 M	
8268006	-	2 x ATR/MGA	G 1/4 M	
8268007	-	2 x ATR/MGA	G 1/4 F	
8268008	-	2 x ATR/MGA	G 3/8 M	
8268022	2 x Ø18	-	G 3/8 M - 1/8 F	



Portagello atomizzatore con ghiera

Nozzle holder with fly nuts

Форсункодержатель распылителя с барашковыми гайками



DIMENSIONS

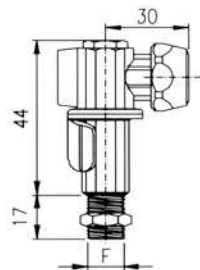

OPTIONALS

Part No.	Page
8275019	324
8275020	324



Part No.	DISC	CONE NOZZLE	F	Pack
8264000	1 x Ø18	-	G 1/4 M	10
8264001	1 x Ø18	-	G 1/4 F	
8264002	1 x Ø18	-	G 3/8 M	
8264003	-	1 x ATR/MGA	G 1/4 M	
8264004	-	1 x ATR/MGA	G 1/4 F	
8264005	-	1 x ATR/MGA	G 3/8 M	



Portagello atomizzatore doppio con ghiera

Double nozzle holder with fly nuts

Двойной форсункодержатель распылителя с барашковыми гайками



DIMENSIONS

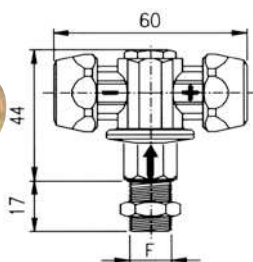

OPTIONALS

Part No.	Page
8275019	324
8275020	324



Part No.	DISC	CONE NOZZLE	F	Pack
8265000	2 x Ø18	-	G 1/4 M	10
8265001	2 x Ø18	-	G 1/4 F	
8265002	2 x Ø18	-	G 3/8 M	
8265003	1 x Ø18	1 x ATR/MGA	G 1/4 M	
8265004	1 x Ø18	1 x ATR/MGA	G 1/4 F	
8265005	1 x Ø18	1 x ATR/MGA	G 3/8 M	
8265006	-	2 x ATR/MGA	G 1/4 M	
8265007	-	2 x ATR/MGA	G 1/4 F	
8265008	-	2 x ATR/MGA	G 3/8 M	



Per completare i portagelli, ordinare »
 To complete the nozzles holder, please order »
 Для комплектации форсункодержателей, заказать »

kit piastrine (Pag. 333-334) / ugelli (cap.6)
 Core kit (Pag. 333-334) / nozzles (cap.6)

Комплект пластин (Стр. 333-334) / форсунок (гл.6)



Portaugello atomizzatore doppio con ghiera.

Double nozzle holder with fly nuts.

Двойной форсункодержатель распылителя с барашковыми гайками.

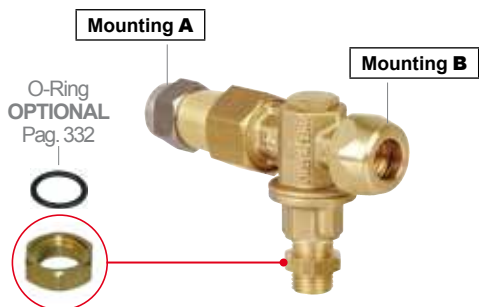

DIMENSIONS

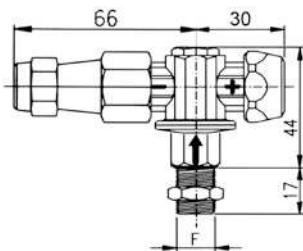

Part No.	DISC (adjustable end)	DISC	F	Pack
8265C0000	1 x Ø15	1 x Ø15	G1/4 M	10
8265C0001	1 x Ø15	1 x Ø15	G3/8 M	

Portaugello atomizzatore doppio regolabile con antigoccia e ghiera.

Double nozzle holder with diaphragm check valve and fly nuts. Adjustable end.

Двойной форсункодержатель распылителя с обратным мембранным клапаном и барашковыми гайками. Регулируемый.

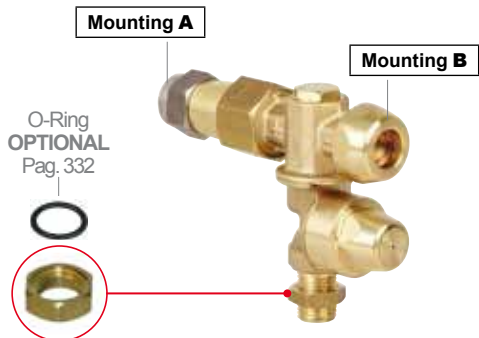

DIMENSIONS

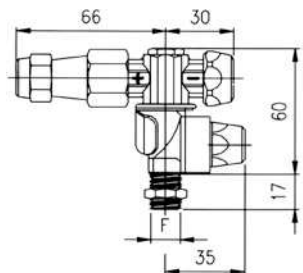

Part No.	DISC (adjustable end)	DISC	F	Pack
8268C0001	1 x Ø15	1 x Ø15	G1/4 M	10
8268C0004	1 x Ø15	1 x Ø15	G1/4 F	

Nebulizzatore leggero registrabile.

Adjustable bent sprayer.

Легкий регулируемый распылитель.

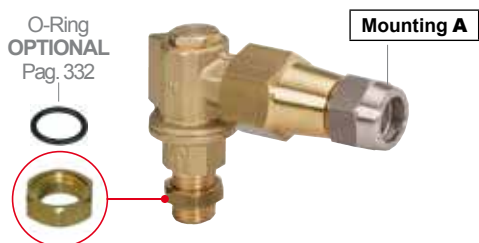

DIMENSIONS

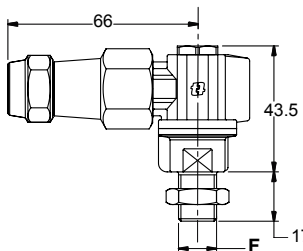

Part No.	DISC (adjustable end)	F	Pack
8264006	1 x Ø15	G 1/4 M	10

Per completare i portaugelli, ordinare piastrine Ø15 mm (Pag. 333)
 To complete the nozzles holder, please order core Ø15 mm (Pag. 333)
 Для комплектации форсункодержателей, заказать пластины Ø15 мм (Стр. 333)



Portaogello atomizzatore doppio regolabile con antigoccia e ghiera

Double nozzle holder with diaphragm check valve and fly nuts. Adjustable end

Двойной регулируемый форсункодержатель распылителя с обратным мембранным клапаном и барашковыми гайками.



DIMENSIONS

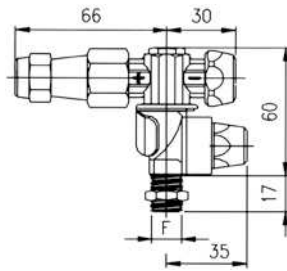

Part No.	DISC (adjustable end)	DISC	CONE NOZZLE	F	Pack
8268009	1 x Ø15	1 x Ø18	-	G 1/4 M	8
8268010	1 x Ø15	1 x Ø18	-	G 1/4 F	
8268011	1 x Ø15	1 x Ø18	-	G 3/8 M	
8268012	1 x Ø15	-	1 x ATR/MGA	G 1/4 M	
8268013	1 x Ø15	-	1 x ATR/MGA	G 1/4 F	
8268014	1 x Ø15	-	1 x ATR/MGA	G 3/8 M	

Portaogello atomizzatore triplo con antigoccia e ghiera

Triple nozzle holder with diaphragm check valve and fly nuts

Тройной форсункодержатель распылителя с обратным мембранным клапаном и барашковыми гайками.



DIMENSIONS

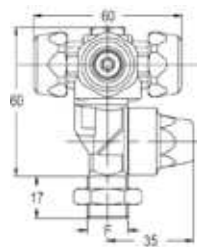

Part No.	DISC	CONE NOZZLE	F	Pack
8269000	3 x Ø18	-	G 1/4 M	8
8269001	3 x Ø18	-	G 1/4 F	
8269002	3 x Ø18	-	G 3/8 M	
8269003	3 x Ø18	-	G 3/8 M - 1/8 F	
8269004	-	3 x ATR/MGA	G 1/4 M	
8269005	-	3 x ATR/MGA	G 1/4 F	
8269006	-	3 x ATR/MGA	G 3/8 M	
8269007	-	3 x ATR/MGA	G 3/8 M - 1/8 F	

Portaogello atomizzatore doppio regolabile con ghiera

Double nozzle holder with fly nuts. Adjustable end

Двойной регулируемый форсункодержатель распылителя с барашковыми гайками



DIMENSIONS

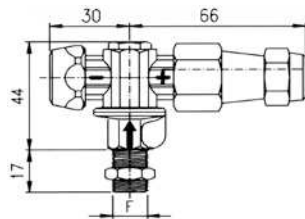

Part No.	DISC (adjustable end)	DISC	CONE NOZZLE	F	Pack
8265009	1 x Ø15	1 x Ø18	-	G 1/4 M	10
8265010	1 x Ø15	1 x Ø18	-	G 1/4 F	
8265011	1 x Ø15	1 x Ø18	-	G 3/8 M	
8265012	1 x Ø15	-	1 x ATR/MGA	G 1/4 M	
8265013	1 x Ø15	-	1 x ATR/MGA	G 1/4 F	
8265014	1 x Ø15	-	1 x ATR/MGA	G 3/8 M	

Portaogello atomizzatore doppio con attacco rapido

Quick fitting double nozzle holder

Двойной форсункодержатель распылителя с фитингами быстрой установки



DIMENSIONS

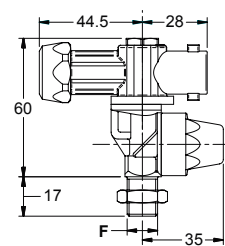

OPTIONALS

Part No.	Type	Pack
8253053	ID/ ISO	25
8253020	ATR/TR	

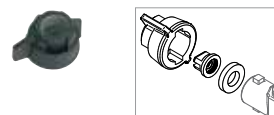

Part No.	DISC	CAP	F	Pack
8268016	1 x Ø18	Quick	G 1/4 M	10
8268017	1 x Ø18	Quick	G 1/4 F	
8268018	1 x Ø18	Quick	G 3/8 M	
8268019	1 x Ø15	Quick	G 1/4 M	
8268020	1 x Ø15	Quick	G 1/4 F	
8268021	1 x Ø15	Quick	G 3/8 M	



Per completare i portaogelli, ordinare »
 To complete the nozzles holder, please order »
 Для комплектации форсункодержателей, заказать »

kit piastrine (Pag. 333-334) / ugelli (cap.6)
 Core kit (Pag. 333-334) / nozzles (cap.6)

Комплект пластин (Стр. 333-334) / форсунок (гл.6)



Double nozzle holder GAS

NEW

Portaogello atomizzatore doppio con antigoccia e ghiera

Double nozzle holder with diaphragm check valve and nuts

Двойной форсункодержатель распылителя с обратным мембранным клапаном и гайками

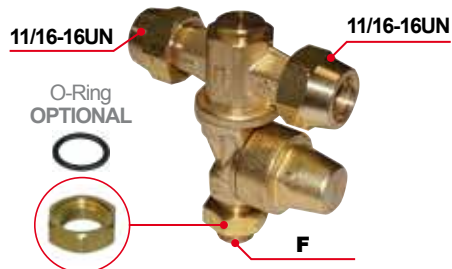

DIMENSIONS

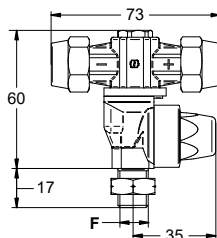

Part No.	DISC	F	Pack
8268028	2 x Ø15	G 1/4 M	10

Spare Parts

Part No.	Part No.
8304103	8304104



Portaogello atomizzatore doppio con antigoccia e girelli.

Double nozzle holder with diaphragm check valve and fly nuts.

Двойной форсункодержатель распылителя с обратным мембранным клапаном и барашковыми гайками



DIMENSIONS

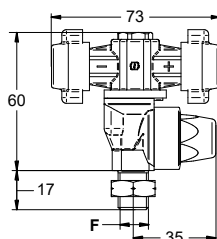

Part No.	DISC	F	Pack
8268029	2 x Ø15	G 1/4 M	10

Spare Parts

Part No.	Part No.
8304103	8304104



Portaogello atomizzatore doppio con antigoccia, girello e ghiera.

Double nozzle holder with diaphragm check valve, fly nut and nut.

Двойной форсункодержатель распылителя с обратным мембранным клапаном, барашковой гайкой и гайкой

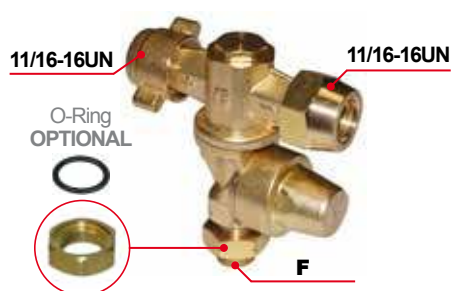

DIMENSIONS

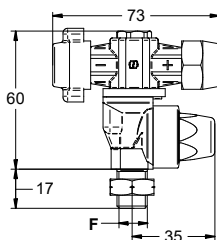

Part No.	DISC	F	Pack
8268030	2 x Ø15	G 1/4 M	10

Spare Parts

Part No.	Part No.
8304103	8304104



Double nozzle holder GAS



Portaugello atomizzatore doppio con antigoccia e ghiera

Double nozzle holder with diaphragm check valve and nuts

Двойной форсункодержатель распылителя с обратным мембранным клапаном и гайками

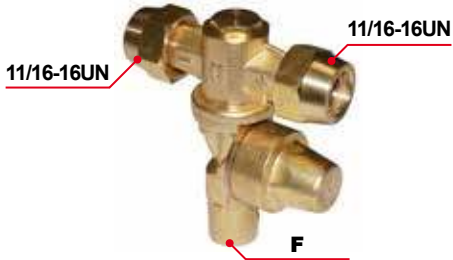

DIMENSIONS

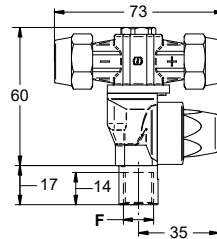

Part No.	DISC	F	Pack
8268031	2 x Ø15	G 1/4 F	10

Spare Parts

Part No.	Part No.
8304103	8304104



Portaugello atomizzatore doppio con antigoccia e girelli.

Double nozzle holder with diaphragm check valve and fly nuts

Двойной форсункодержатель распылителя с обратным мембранным клапаном и барашковыми гайками

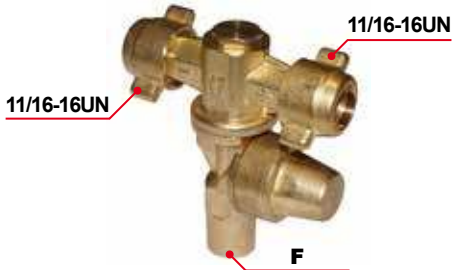

DIMENSIONS

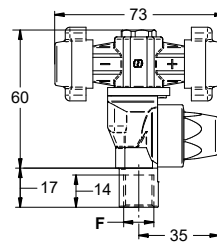

Part No.	DISC	F	Pack
8268032	2 x Ø15	G 1/4 F	10

Spare Parts

Part No.	Part No.
8304103	8304104



Double nozzle holder NPT



Portaogello atomizzatore doppio con antigoccia e ghiera

Double nozzle holder with diaphragm check valve and nuts

Двойной форсункодержатель распылителя с обратным мембранным клапаном и гайками

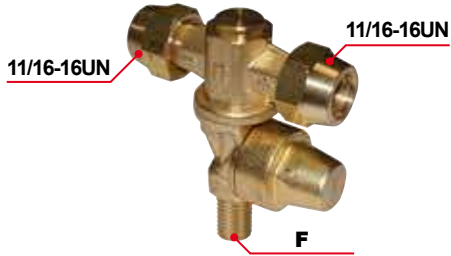

DIMENSIONS

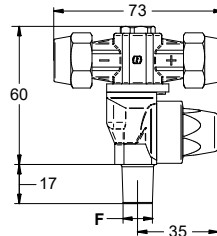

Part No.	DISC	F	Pack
8268036	2 x Ø15	1/4 NPT M	10

Spare Parts

Part No.	Part No.
8304103	8304104

Portaogello atomizzatore doppio con antigoccia e girelli.

Double nozzle holder with diaphragm check valve and fly nuts.

Двойной форсункодержатель распылителя с обратным мембранным клапаном и барашковыми гайками

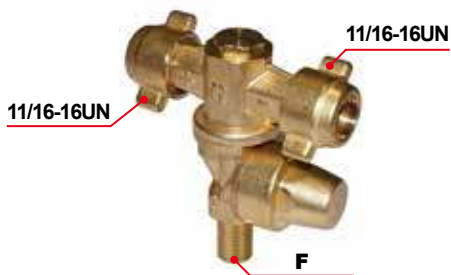

DIMENSIONS

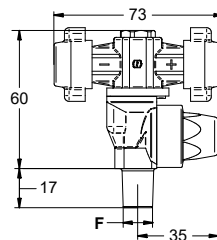

Part No.	DISC	F	Pack
8268037	2 x Ø15	1/4 NPT M	10

Spare Parts

Part No.	Part No.
8304103	8304104

Portaogello atomizzatore doppio con antigoccia, girello e ghiera.

Double nozzle holder with diaphragm check valve, fly nut and nut.

Двойной форсункодержатель распылителя с обратным мембранным клапаном, барашковой гайкой и гайкой

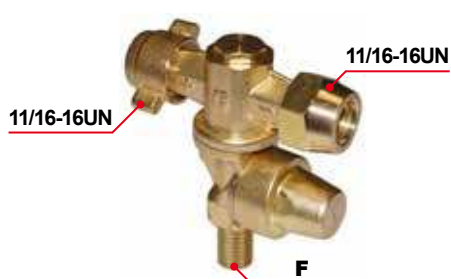

DIMENSIONS

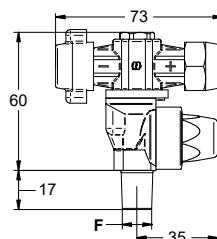

Part No.	DISC	F	Pack
8268038	2 x Ø15	1/4 NPT M	10

Spare Parts

Part No.	Part No.
8304103	8304104

Double nozzle holder NPT



Portaogello atomizzatore doppio con antigoccia e ghiera

Double nozzle holder with diaphragm check valve and nuts

Двойной форсункодержатель распылителя с обратным мембранным клапаном и гайками

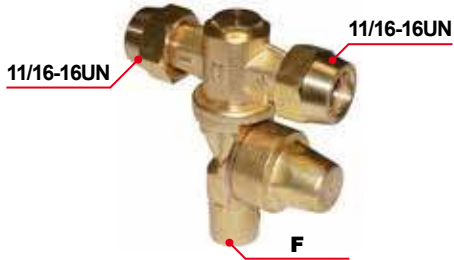

DIMENSIONS

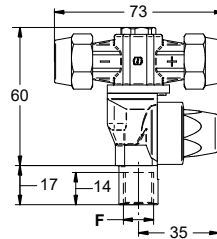

Part No.	DISC	F	Pack
8268033	2 x Ø15	1/4 NPT F	10

Spare Parts

Part No.	Part No.
8304103	8304104



Portaogello atomizzatore doppio con antigoccia e girelli.

Double nozzle holder with diaphragm check valve and fly nuts

Двойной форсункодержатель распылителя с обратным мембранным клапаном и барашковыми гайками

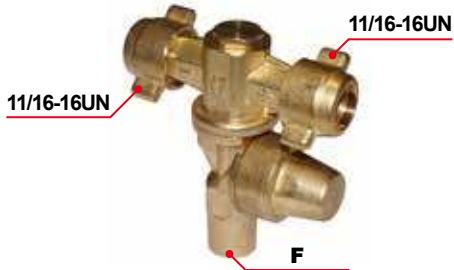

DIMENSIONS

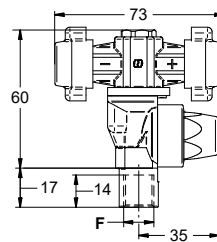

Part No.	DISC	F	Pack
8268034	2 x Ø15	1/4 NPT F	10

Spare Parts

Part No.	Part No.
8304103	8304104



Guarnizioni O-Rings per portaugelli.

O-Ring gaskets for nozzle holder.

Кольцевые уплотнения для держателя форсунок.



	Part No.	Type	F	Pack
A	G00001093	EPDM	G 1/4	10
B	G00001116	VITON®	G 1/4	10

	Part No.	Type	F	Pack
A	G00001106	EPDM	G 3/8	10
B	G00001126	VITON®	G 3/8	10

Ghiere in ottone per getti atomizzatore

Brass fly nuts for nozzle holders

Зажимные латунные гайки для распылителя



Part No.	suitable for DISC / NOZZLE	Pack
8304026	Ø15 mm	10

Part No.	suitable for DISC / NOZZLE	Pack
8270002	Ø15 mm	
8270000	Ø18 mm	10
8270001	ATR / MGA	

ASSEMBLY

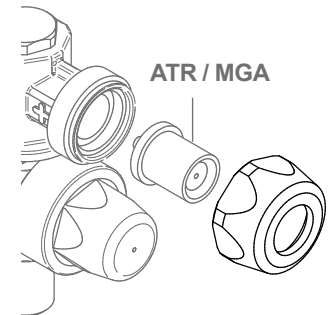

GASKET + DISC + CORE Ø 15

Guarnizione per piastrina inox Ø 15 mm

Gasket for s/s core Ø 15 mm

Прокладка для пластины из нержавеющей стали Ø 15 мм

Piastrina in ceramica Ø 15 mm

Ceramic disc Ø 15 mm

Керамическая пластина Ø 15 мм

Convogliatore in acciaio inox Ø 15 mm

Stainless steel core Ø 15 mm

Направляющее устройство из нержавеющей стали Ø 15 мм

Part No.	Pack
 G00002032	50

Part No.	Hole Ø mm	Pack
 8259167	0,8	100
8259168	1,0	100
8259169	1,2	100
8259170	1,5	100
8259171	1,8	100
8259172	2,0	100

Part No.	Hole Ø mm	Pack
 8259148	blank	100
8259237	1,2	100
8259337	1,5	100
8259338	1,8	100

DISC	CORE	DISC Hole Ø mm	CORE Hole Ø mm	bar	l/1'	Pressure psi	Pack
8259167	8259148	0,8	blank	10	1,17	145	100
				20	1,44	290	
				30	1,76	435	
				40	2,00	580	
				50	2,30	725	
8259168	8259148	1,0	blank	10	1,47	145	100
				20	1,82	290	
				30	2,22	435	
				40	2,54	580	
				50	2,91	725	
8259169	8259148	1,2	blank	10	1,73	145	100
				20	2,14	290	
				30	2,61	435	
				40	2,99	580	
				50	3,43	725	
8259169	8259237	1,2	1,2	10	2,98	145	100
				20	3,70	290	
				30	4,55	435	
				40	5,21	580	
				50	6,00	725	
8259170	8259148	1,5	blank	10	3,22	145	100
				20	3,98	290	
				30	4,83	435	
				40	5,56	580	
				50	6,36	725	
8259170	8259237	1,5	1,2	10	4,79	145	100
				20	5,85	290	
				30	7,03	435	
				40	8,02	580	
				50	9,14	725	
8259170	8259337	1,5	1,5	10	4,77	145	100
				20	5,88	290	
				30	7,11	435	
				40	8,16	580	
				50	9,33	725	
8259171	8259148	1,8	blank	10	2,73	145	100
				20	3,37	290	
				30	4,08	435	
				40	4,68	580	
				50	5,35	725	
8259171	8259337	1,8	1,5	10	6,43	145	100
				20	7,87	290	
				30	9,06	435	
				40	10,63	580	
				50	11,94	725	
8259171	8259338	1,8	1,8	10	6,73	145	100
				20	8,27	290	
				30	10,11	435	
				40	11,51	580	
				50	13,20	725	
8259172	8259148	2,0	blank	10	3,16	145	100
				20	3,92	290	
				30	4,77	435	
				40	5,47	580	
				50	6,28	725	
8259172	8259338	2,0	1,8	10	7,27	145	100
				20	8,96	290	
				30	10,75	435	
				40	12,40	580	
				50	14,14	725	

Assembly - Ø15 Adjustable

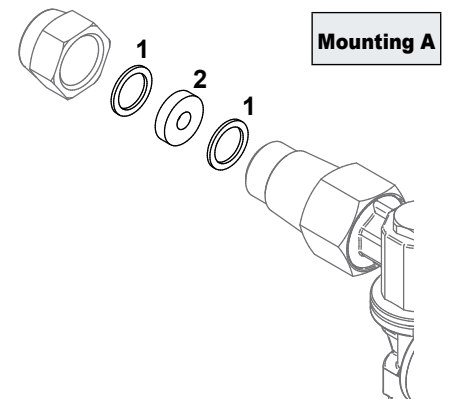

Core kit assembly - Ø15

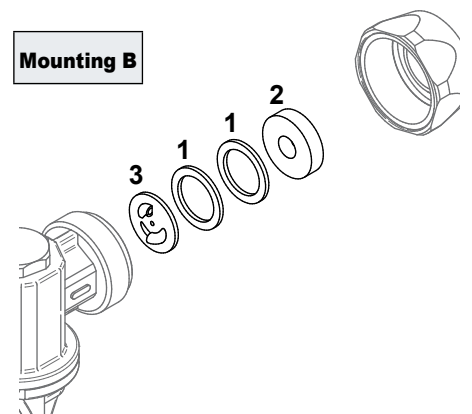

CORE KITS Ø 18

Kit piastrine Ø 18 mm

Core kit Ø 18 mm

Комплект пластин Ø 18 мм



HOW TO ORDER

KIT	TIP mm	CORE mm	bar	l/1'	Pressure psi	Pack
8259211	Ø 0,8	blank	10	1,36	145	25
			20	1,66	290	
			30	2,00	435	
			40	2,28	580	
			50	2,60	725	
8259212	Ø 1,0	blank	10	1,40	145	25
			20	1,71	290	
			30	2,06	435	
			40	2,35	580	
			50	2,68	725	
8259314	Ø 1,0	Ø 1,0	10	1,93	145	25
			20	2,40	290	
			30	2,91	435	
			40	3,35	580	
			50	3,84	725	
8259213	Ø 1,2	blank	10	1,87	145	25
			20	2,31	290	
			30	2,80	435	
			40	3,22	580	
			50	3,68	725	
8259313	Ø 1,2	Ø 1,0	10	3,08	145	25
			20	3,76	290	
			30	4,52	435	
			40	5,16	580	
			50	5,87	725	
8259214	Ø 1,2	Ø 1,2	10	3,16	145	25
			20	3,89	290	
			30	4,73	435	
			40	5,41	580	
			50	6,20	725	
8259215	Ø 1,5	blank	10	2,60	145	25
			20	3,19	290	
			30	3,82	435	
			40	4,40	580	
			50	5,01	725	
8259216	Ø 1,5	Ø 1,2	10	4,41	145	25
			20	5,45	290	
			30	6,61	435	
			40	7,58	580	
			50	8,68	725	
8259217	Ø 1,5	Ø 1,5	10	4,66	145	25
			20	5,74	290	
			30	6,96	435	
			40	7,96	580	
			50	9,11	725	
8259218	Ø 1,8	blank	10	2,84	145	25
			20	3,56	290	
			30	4,35	435	
			40	5,03	580	
			50	5,78	725	
8259219	Ø 1,8	Ø 1,5	10	6,16	145	25
			20	7,40	290	
			30	8,80	435	
			40	9,96	580	
			50	11,28	725	
8259220	Ø 1,8	Ø 1,8	10	6,41	145	25
			20	7,82	290	
			30	9,51	435	
			40	10,78	580	
			50	12,33	725	
8259221	Ø 2,0	blank	10	3,39	145	25
			20	4,23	290	
			30	5,16	435	
			40	5,94	580	
			50	6,83	725	
8259222	Ø 2,0	Ø 1,8	10	7,14	145	25
			20	8,63	290	
			30	10,47	435	
			40	11,79	580	
			50	13,46	725	

ASSEMBLING - Ø18

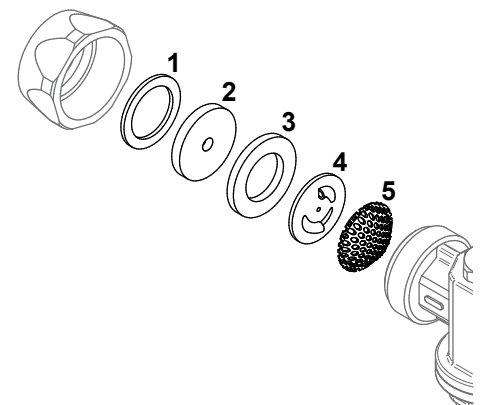

SPARE PARTS

	Part No.	Hole Ø mm	Pack	
1	G00002046	/	50	
		8259059	0,8	100
		8259060	1,0	100
2	G00002046	8259061	1,2	100
		8259062	1,5	100
		8259063	1,8	100
		8259064	2,0	100
3	G00002022	/	50	
		CORE		
4	G00002022	8259067	blank	100
		8259068	1,0	100
		8259069	1,2	100
		8259070	1,5	100
5	G00002022	8259071	1,8	100
		8259073	/	100

CORE KITS Ø 30

Kit piastrine Ø 30 mm

Core kit Ø 30 mm

Комплект пластин Ø 30 мм



HOW TO ORDER

KIT	TIP mm	CORE mm	bar	l/1'	Spray angle	Pressure psi	Capacity USG/min'	Pack
8259207	Ø 1,8	Ø 1,5	10	4,95	50°	150	1,32	25
			20	7,00	50°	300	1,80	25
			30	8,60	55°	450	2,20	25
			40	9,90	55°	600	2,60	25

Fino ad esaurimento
 Selling out
 до окончания складских запасов

ASSEMBLING - Ø30

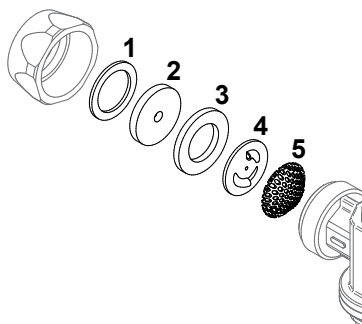

SPARE PARTS

	Part No.	Hole Ø mm	Pack
1	G00002041	/	50
	8259075	1,0	25
	8259076	1,2	25
	8259079	2,0	25
3	G00001098	/	50
	8259084	1,2	25
4	8259086	1,8	25
	8259088	/	25

Aste inox AISI 304 Ø1/2", per barre da irrorazione.

AISI 304 stainless steel rods, Ø1/2" for spraying booms.

Штанги из нержавеющей стали AISI 304 Ø1/2", для распылительных штанг.

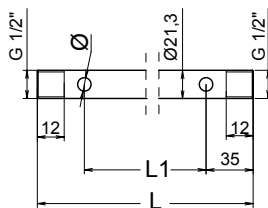

Part No.	L mm	No. of holes	L1 mm	Ø mm	Pack
8292023	800	3	360		
8292022	1000	4	310		
8292024	1000	5	230	7	10
8292025	1200	5	280		
8292026	1400	5	330		
8292027	1600	5	380		



Per completare, ordinare
 To complete, please order
 Для комплектации заказать



Pag. 338-339

OPTIONALS



Pag. 336



Pag. 337



Pag. 337

Rubinetti in ottone a sfera.

Brass ball cocks.

Шаровые латунные краны.



Part No.	Connections	Closing Rotation	Pack
8306002	G 1/2 M	clockwise	10
	G 3/8 M		
8306003	G 1/2 M	anticlockwise	10
	G 1/2 M		
8306004	G 1/2 M	anticlockwise	10
	G 3/8 M		
8306005	G 1/2 M	clockwise	10
	G 1/2 M		



Part No.	Connections	Pack
8306000	G 3/4 F	10
8306001	G 1/2 M	

a farfalla
 t-handle
 с ручкой-
 бабочкой

Barre irroranti a T
 - Senza portaugelli.
 - Fornita smontata.
 - Tubi inox Ø 20 mm.

Portaugelli da ordinare separatamente.

T-spraying booms
 - Nozzle-holders not included.
 - Supplied disassembled.
 - Ø 20 mm stainless steel pipes.

Nozzle-holders to be ordered separately.

Тройниковые распылительные штанги
 - Без форсункодержателя.
 - Поставляется в разобранном виде.
 - Трубы из нержавеющей стали Ø 20 мм.

Форсункодержатели заказываются отдельно.



OPTIONALS



Pag. 336

Part No.	Nozzles	Pack
8290000	3 + 3	5
8290001	4 + 4	5
8290002	5 + 5	5

SPARE PARTS

Part No.	Description	Pack
8294002	Rosetta e molla per barre irroranti. Washer and spring for spraying booms.	10
8294003	Шайба и пружины для распылительных штанг.	10



Portaugello per barre con ugello protezione

Nozzle-holder for spraying booms with nozzle and protection

Форсункодержатель для штанг с форсункой и защитой

Part No.	Material	Ugello / Nozzle / Buse	Pack
A 8275000	ceramica ceramic керамика	Ugello standard: Ø1,2 mm Standard nozzle: Ø1,2 mm Станд.форсунка диам. 1,2 мм	10

Part No.	Material	Ugello / Nozzle / Buse	Pack
B 8275009	acciaio INOX stainless steel нерж.сталь	Ugello standard: Ø1,2 mm Standard nozzle: Ø1,2 mm Станд.форсунка диам. 1,2 мм	10

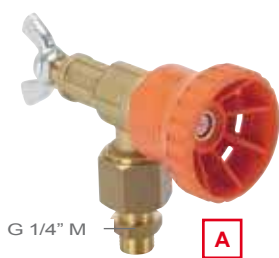

G 1/4" M

A

SPARE PARTS

Part No.	Description	Pack
G00002070	Gasket	50
G00001120	O-Ring	50

OPTIONALS

Description
 Nozzle Pag. 321



G 1/4" M

B

Aste curve inox AISI 304 Ø 20x1mm per gruppi ventola. Si realizzano versioni su disegno per ogni tipo di ventola.

AISI 304 stainless steel curved rods 20x1mm for ventilating fan units. Customized production available on request.

Стержни из нержавеющей стали AISI 304 20x1 мм для вентиляторных блоков. Изготавливаются по чертежу для всех видов вентиляторов.

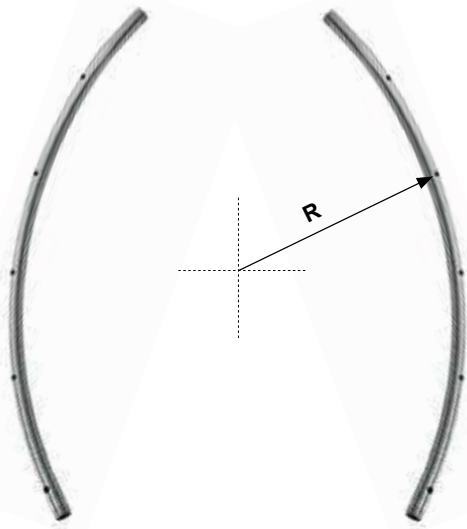

Part No.	ØV mm	R mm	Øe mm	No. of holes	holes Ø	Pack
8290011	600	345	21,3x1	6	7 mm	10
8290012	700	395	21,3x1	7	7 mm	10
8290013	800	445	21,3x1	7	7 mm	10
8290014	900	495	21,3x1	7	7 mm	10
8290015	1000	545	21,3x1	7	7 mm	10

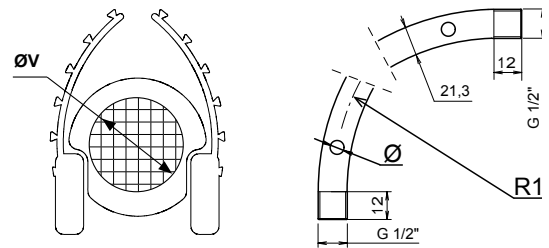

Per completare, ordinare
 To complete, please order
 Для комплектации заказать



Pag. 338-339

OPTIONALS



Pag. 325



Pag. 337



Pag. 337

Morsetto in ottone nichelato con o-ring di tenuta per tubi Ø 20mm (1/2").

Nickel-plated brass clamp with o-ring gasket for rods Ø 20mm (1/2").

Зажим из никелированной латуни с кольцевым уплотнением для труб Ø 20 мм (1/2").

Part No.	F1	D mm	H mm	Pack
8272000	G 1/4 F 20 -1/2"G	30	30	25
8272001	G 1/4 F 20 -1/2"G	37,5		

Part No.	F1	D mm	H mm	Pack
8272006	G 1/4 M 20 -1/2"G	30	30	25

Part No.	F1	D mm	H mm	Pack
8272007	G 3/8 M 20 - G1/2	37,5	25	
8272008	G 1/2 M 20 - G1/2	49	25	

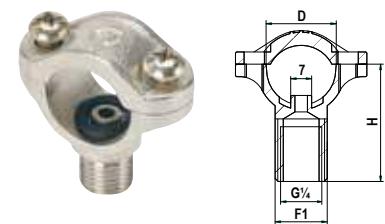
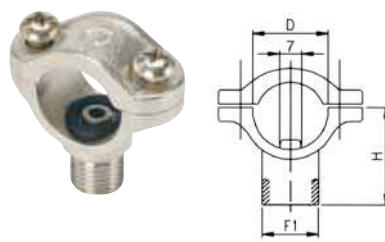

Morsetto in ottone nichelato con cavallotto filettato e o-ring di tenuta per tubi Ø 20mm (1/2").

Nickel-plated brass clamp with o-ring gasket. Mounting hole of Ø 20mm (1/2").

Зажим из никелированной латуни с резьбовым хомутом и кольцевым уплотнением для труб Ø 20 мм (1/2").

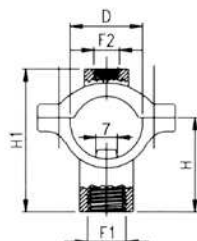

Part No.	F1	F2	D mm	H mm	H1 mm	Pack
8272002	G 1/4 F	M8	20 -1/2"G	30	45,3	25
8272003	G 1/4 F	M8	20 -1/2"G	37,5	52,8	

Raccorderia in ottone

Brass fittings

Латунные фитинги

Tappo femmina
Female plug
 Заглушка с внутренней резьбой

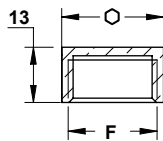

Part No.	F		Pack
8304022	G 1/2"	24	25
8304069	G 1/2"	24	25 with gasket

Tappo maschio
Male plug
 Заглушка с наружной резьбой

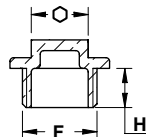

Part No.	F	H mm		Pack
8304050	G 1/4"	8	10	25
8304051	G 3/8"	10	15	
8304052	G 1/2"	11	16	
8304000	G 3/4"	12	32	

Nipplo
Nipple
 Ниппель

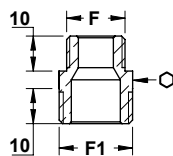

Part No.	F	F1		Pack
8304009	G 3/8"	G 1/2"	21	25
8304010	G 1/2"	G 1/2"	21	25
8304057	G 3/4"	G 3/4"	32	25
8304086	G 1"	G 1"	36	10

Giunto autobloccante con girello
Self-locking union with fly nut
 Самоблокировочное соединение с барашковой гайкой

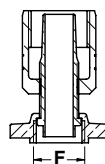

Part No.	Hose Ø mm	F	Pack
8308006	10x17	G 1/2"	10
8308007	10x19	G 1/2"	
8308008	10x21	G 1/2"	
8308009	13x24	G 1/2"	

Portagomma curvo con girello
Elbow hosetail with fly nut
 Штуцер-угольник с барашковой гайкой

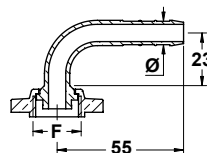

Part No.	Ø mm	F	Pack
8304007	10	G 1/2"	25
8304008	13	G 1/2"	

Portagomma curvo con ghiera
Elbow hosetail with nut
 Штуцер-угольник с барашковой гайкой

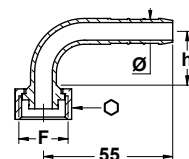

Part No.	Ø mm	F	h mm		Pack
8304037	10	G 1/2"	23	24	25
8304038	13	G 1/2"	26,5	24	

Portagomma diritto con girello
Hosetail with fly nut
 Прямой штуцер с барашковой гайкой

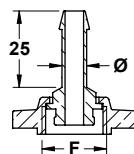

Part No.	Ø mm	F	Pack
8304003	8	G 1/2"	50
8304004	10	G 1/2"	
8304005	13	G 1/2"	

Portagomma diritto con ghiera
Hosetail with fly nut
 Прямой штуцер с барашковой гайкой

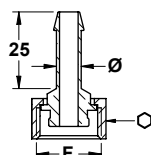

Part No.	Ø mm	F		Pack
8304054	8	G 1/2"	24	50
8304055	10	G 1/2"	24	
8304056	13	G 1/2"	24	

Raccorderia in ottone

Brass fittings

Латунные фитинги

Portagomma filettato
 Threaded hosetail
 Резьбовой штуцер

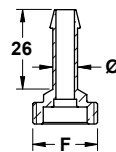

Part No.	Ø mm	F	Pack
8304011	8	G 1/2"	
8304012	10	G 1/2"	50
8304013	13	G 1/2"	

Giunto semplice diritto
 Simple union
 Простое прямое соединение

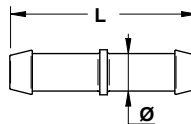

Part No.	Ø mm	L mm	Pack
8308003	8	45	
8308004	10	50	25
8308005	13	50	

Giunto combinato pesante
 Heavy combined union
 Комбинированное тяжелое соединение

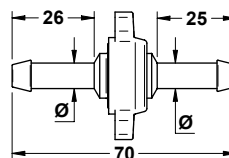

Part No.	Ø mm	Pack
8308000	8	
8308001	10	25
8308002	13	

Girello
 Fly nut
 Барашковая гайка

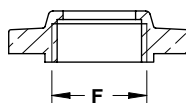

Part No.	F	Pack
8304006	G 1/2"	25

Ghiera
 Nut
 Зажимная гайка

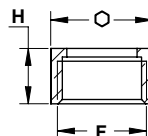

Part No.	F	H mm	⌋	Pack
8304036	G 1/2"	13	24	25
8304039	G 3/4"	18	32	10

Guarnizione per raccordo con girello
 Gasket for swivel fitting
 Прокладка для фитинга с барашковой гайкой



Part No.	Ø	Pack
G00002035	1/2"	50

Nipplo per barre irroranti
 Nipple for spraying booms
 Ниппель для распылительных штанг

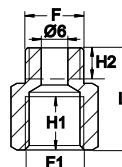

Part No.	F	F1	L mm	H mm	H12 mm	⌋	Pack
I00000003	G1/4	G1/4	23	12	7	17	
I00000004	G1/4	G1/4	30	16	7	17	1

Nipplo per barre irroranti
 Nipple for spraying booms.
 Ниппель для распылительных штанг

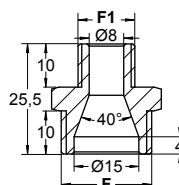

Part No.	F	F1	⌋	Pack
I00000005	G1/2	G1/4	22	1

Raccorderia in ottone

Brass fittings

Латунные фитинги

Curva in ottone
 Brass elbow
 Латунное колено

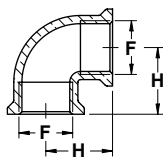

Part No.	F	H mm	Pack
8304046	3/8"	21,5	25
8304047	1/2"	26,0	
8304048	3/4"	28,5	
8304049	1"	37,0	

Curva in ottone
 Brass elbow
 Латунное колено

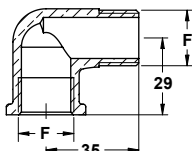

Part No.	F	Pack
8304031	1/2"	25

Curva in ottone
 Brass elbow
 Латунное колено

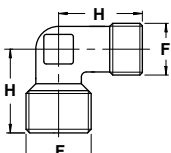

Part No.	F	H mm		Pack
R0000072	G 3/4 - G 1/2	34,0	19	25
R0000073	G 3/4 - G 3/4	40,0	27	

Giunto a 3 vie in ottone
 Brass 3-way union.
 3-ходовое латунное соединение.

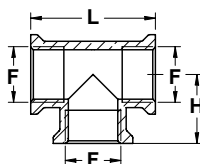

Part No.	F	H mm	L mm	Pack
8304043	1/2"	26,0	47	25
8304044	3/4"	28,5	57	
8304045	1"	37,0	73	

Giunto a 3 vie in ottone
 Brass 3-way union.
 3-ходовое латунное соединение.

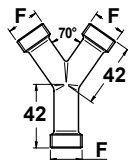

Part No.	F	Pack
8304027	1/2"	25

Giunto a 3 vie in ottone
 Brass 3-way union.
 3-ходовое латунное соединение.

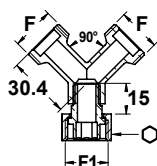

Part No.	F	F1		Pack
8304040	1/2"M	1/2"F	24	25

Raccorderia

Fittings

ФИТИНГИ

Raccordi a "L"
 "L" fittings
 L-образные фитинги



Part No.	A	B	Pack
R0000301	G 1/4 F	G 1/4 F	25
R0000302	G 3/8 F	G 3/8 F	25
R0000303	G 1/4 F	G 1/2 F	25
R0000304	G 1/4 M	G 1/4 M	25
R0000305	G 3/8 M	G 3/8 M	25
R0000306	G 1/2 M	G 1/2 M	25
R0000307	G 3/8 M	G 1/4 M	25
R0000308	G 1/2 M	G 3/8 M	25
R0000309	G 1/4 F	G 1/4 M	25
R0000310	G 3/8 F	G 3/8 M	25
R0000311	G 1/2 F	G 1/2 M	25
R0000312	G 3/8 F	G 1/4 M	25
R0000313	G 1/4 F	G 3/8 M	25

Raccordi a "T"
 "T" fittings
 T-образные фитинги

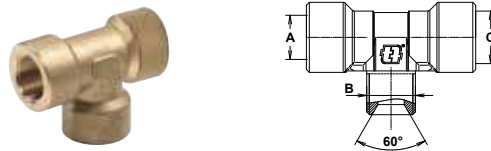

Part No.	A	B	C	Pack
R0000314	G 1/2 F	G 1/2 F	G 1/2 F	25
R0000315	G 3/8 F	G 3/8 F	G 3/8 F	25
R0000316	G 3/8 F	G 3/8 M	G 3/8 F	25
R0000317	G 3/8 F	G 3/8 F	G 3/8 M	25
R0000318	G 3/8 F	G 1/4 M	G 3/8 F	25
R0000319	G 3/8 F	G 1/4 F	G 3/8 F	25
R0000320	G 3/8 F	G 1/4 F	G 3/8 M	25

Nipplo in ottone zincato
 Zinc plated brass nipple
 Ниппель из оцинкованной латуни



Part No.	INLET	OUTLET		Pack
0115710100	G 1/4 M	G 1/4 F	22	25
0115710070	G 1/4 F	G 1/4 F	22	25
0115710060	G 1/4 F	G 3/8 M	22	25
0115710020	G 3/8 F	G 1/4 F	22	25
0115710110	G 1/2 F	G 1/4 F	24	25
0115710140	G 1/2 M	G 1/4 F	22	25

Nipplo in ottone
 Brass nipple
 Ниппель из латуни



Part No.	INLET	OUTLET		Pack
R0000220	R 1/4 M	R 1/4 M	14	25
R0000212	G 3/8 F	G 1/4 F	22	25
150090	G 3/8 F	G 3/8 F	22	25
110007	G 3/8 M	G 1/4 M	19	25
110008	G 3/8 M	G 3/8 M	19	25

Nipplo in acciaio inox
 Stainless steel nipple
 Ниппель из нержавеющей стали



Part No.	INLET	OUTLET		Pack
N00200008	G 1/4 F	G 1/4 F	17	25

Nipplo in acciaio zincato
 Zinc plated steel nipple
 Ниппель из оцинкованной стали



Part No.	INLET	OUTLET		Pack
R0000158	G 3/8 F	G 1/4 F	22	25
410001	G 3/8 M	G 1/4 M	19	25
410000	G 3/8 M	G 3/8 M	19	25

Coperchi in gomma (chiusi).
 Rubber lids (closed).
 Резиновые крышки (закрытые).

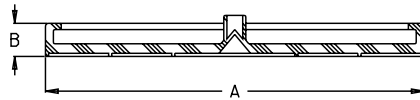

Part No.	A mm	B mm	Pack
8184000	265	20	
8184001	365	20	10
8184002	454	22	

Passatubi in gomma.
 Rubber pipe duct.
 Резиновый трубный канал.

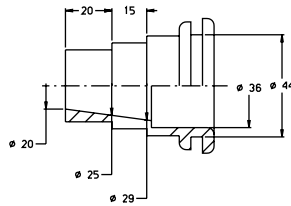

Part No.	Pack	
8316000	Type 1	10

Passatubi in gomma.
 Rubber pipe duct.
 Резиновый трубный канал.

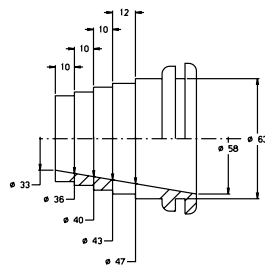

Part No.	Pack	
8316001	Type 2	10

Avvolgitubo manuale in alluminio pressofuso.
 - Supporti laterali, rullo centrale e asse centrale in acciaio verniciato;
 - Dischi laterali in alluminio verniciato a polvere ad alta resistenza antiurto;
 - Giunti girevoli in acciaio inox e boccole in materiale plastico autolubrificante;
 - Blocco anti-srotolamento con pomello, manopola ergonomica e due fascette ferma tubo

Die casting aluminium manual hose-reel.
 - Side supports, central roller and central axis in painted steel;
 - Side discs in powder painted die-cast aluminum;
 - Stainless steel swivels and self-lubricating plastic bushings;
 - Anti-roll lock with knob, ergonomic handle and two clamps to fasten the hose

Ручной барабан для шланга из литого алюминия
 - боковые суппорты, центральная втулка и центральные оси выполнены из окрашенной стали;
 - боковые диски из алюминия, окрашенного методом порошкового напыления, что дает поверхности особую прочность;
 - вращающиеся крепления из нерж.стали, а втулки пластика, не нуждающегося в дополнительной смазке;
 - блокировка размотки выполняется при помощи круглой рукоятки, эргономичной ручки и двух пластин, блокирующих шланг.



Fino ad esaurimento
 Selling out
 до окончания складских запасов

Fino ad esaurimento
 Selling out
 до окончания складских запасов

Fino ad esaurimento
 Selling out
 до окончания складских запасов

Note: tubo escluso
 Notes: without pipe
 Прим.: Шланг не включен

Part No.	bar	INLET	OUTLET	HOSE CAPACITY		Pack
				Ø mm	LENGTH m	
HR50 4131800003	300	G 3/8 M	G 3/8 M	15,0	100	13 1
				16,8	80	
				17,8	75	
				19,5	58	
HR50 4131800004	200	G 1/2 M	G 1/2 M	15,0	100	13 1
				16,8	80	
				17,8	75	
				19,5	58	
HR70 4131800005	100	G 3/8 M	G 3/8 M	17,0	85	11,5 1
				19,0	70	
				20,0	62	
				21,0	56	
HR70 4131800006	100	G 1/2 M	G 1/2 M	24,0	45	11,5 1
				17,0	85	
				19,0	70	
				20,0	62	
HR50L 4131800016	300	G 3/8 M	G 3/8 M	21,0	56	14,5 1
				24,0	45	
				15,0	130	
				16,8	100	
HR50L 4131800017	100	G 1/2 M	G 1/2 M	17,8	95	12,5 1
				19,5	75	
				17,0	110	
				19,0	90	
HR70L 4131800017	100	G 1/2 M	G 1/2 M	20,0	80	12,5 1
				21,0	72	
				24,0	55	

Avvolgitubo manuale

- Flange in lamiera verniciata
- Cilindro in lamiera verniciata
- Base in tubolare verniciato
- Giunti girevoli in ottone
- Pressione max 80 bar
- Entrata filettata G 1/2 M

Manual hose reel

- painted sheet discs
- painted sheet steel cylinder
- painted sheet steel frame
- Brass swivel fittings
- Max pressure 80 bar
- BSP 1/2 M threaded inlet

Ручной барабан для шланга

- Фланцы из крашеного листового металла
- Цилиндр из крашеного листового металла
- Основание из крашеного трубчатого материала
- Поворотные латунные фитинги
- Максимальное давление 80 бар
- Резьбовой вход G 1/2 M.



Part No.	INLET bar	OUTLET	HOSE CAPACITY		A mm	B mm	C mm	D mm	E mm	
			Ø mm	LENGHT m						
8214000	80	G 1/2 M	G 1/2 M	18,0	50	492	200	47,8	195,5	397

DIMENSIONS

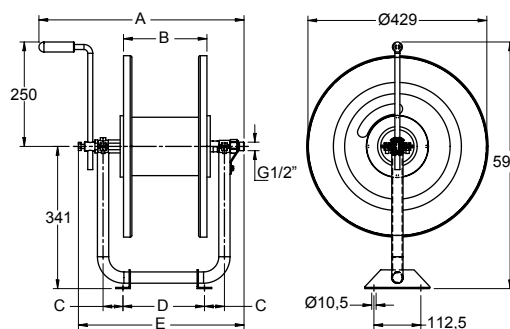

Avvolgitubo manuale.
 Fornito smontato.

Manual hose reels.
 Supplied disassembled.

Ручной барабан для шланга.
 Поставляется в разобранном виде.



Fino ad esaurimento
 Selling out
 до окончания складских запасов

Part No.	INLET bar	OUTLET	HOSE CAPACITY		A mm	B mm	
			Ø mm	LENGHT m			
8214003	100	G 1/2	G 1/2	18,0	100	352	232
8214004	100	G 1/2	G 1/2	18,0	150	447	327
8214007	150	G 3/8	G 3/8	18,0	100	352	232

DIMENSIONS

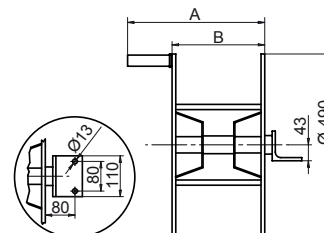

Avvolgitubo manuale

- Bobina in polipropilene rinforzata con fibra di vetro
- Telaio in acciaio zincato
- Snodo girevole in ottone
- Capacità 50 m, tubo Ø18 mm
- Pressione max di lavoro 100 Bar

Manual hose reel

- Fiberglass-reinforced polypropylene reel
- Galvanised steel frame
- Brass swivel fitting
- Capacity 50 m, hose Ø 18 mm
- Max. working pressure 100 Bar

Ручной барабан для шланга

- Барабан из полипропилена, усиленного стекловолокном
- Рама из оцинкованной стали
- Латунное поворотное соединение
- Емкость 50 м, шланг Ø 18 мм
- Максимальное рабочее давление 100 бар



Part No.	bar	INLET	OUTLET	HOSE CAPACITY	
				Ø mm	LENGHT m
8214002	100	G 1/2	G 1/2	18,0	50

DIMENSIONS

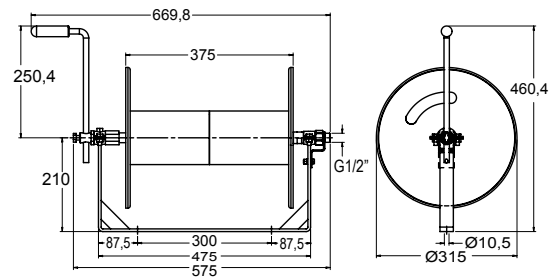

Tubo in PVC rinforzato.
 Reinforced PVC pipe.
 Труба из усиленного ПВХ.



Part No.	d mm	D mm	WORKING PRESS.	BURSTING PRESS.	COLOUR	Order multiples of
8296000	8	13	20 bar (290 psi)	75 bar (1090 psi)	Beige	100 m
8296001	10	15	20 bar (290 psi)	75 bar (1090 psi)	Beige	100 m
8296014	13	19	20 bar (290 psi)	60 bar (870 psi)	Beige	100 m
8296007	19	26,5	20 bar (290 psi)	55 bar (798 psi)	Beige	100 m
8296008	25	33,5	20 bar (290 psi)	50 bar (725 psi)	Beige	50 m
8296002	8	14	40 bar (580 psi)	120 bar (1740 psi)	Blue	100 m
8296003	10	16	40 bar (580 psi)	120 bar (1740 psi)	Blue	100 m
8296015	13	21	40 bar (580 psi)	120 bar (1740 psi)	Blue	100 m
8296004	8	15	80 bar (1160 psi)	270 bar (3915 psi)	Red	100 m
8296005	10	18	80 bar (1160 psi)	270 bar (3915 psi)	Red	100 m
8296006	13	21	80 bar (1160 psi)	270 bar (3915 psi)	Red	100 m

Manometri alla glicerina

Glycerin pressure gauges

Глицериновые манометры



ABS Ø=63 mm
 F=G1/4"

Part No.	RANGE	Pack
8302002	0÷10 bar	5
8302004	0÷25 bar	5
8302006	0÷40 bar	5
8302009	0÷100 bar	5



ABS Ø=63 mm
 F=G1/4"

Part No.	RANGE	Pack
8302050	0÷4 bar	5
8302051	0÷6 bar	5
8302052	0÷10 bar	5
8302053	0÷16 bar	5
8302054	0÷25 bar	5
8302055	0÷30 bar	5
8302056	0÷40 bar	5
8302057	0÷60 bar	5
8302058	0÷80 bar	5
8302059	0÷100 bar	5



INOX Ø=63 mm
 F=G1/4"

Part No.	RANGE	Pack
8302100	0÷4 bar	5
8302101	0÷6 bar	5
8302102	0÷10 bar	5
8302103	0÷16 bar	5
8302104	0÷25 bar	5
8302106	0÷40 bar	5
8302107	0÷60 bar	5
8302109	0÷100 bar	5



INOX Ø=100 mm
 F=G1/2"

Part No.	RANGE	Pack
8302154	0÷25 bar	3
8302156	0÷40 bar	3
8302157	0÷60 bar	3

* Adatto per scatole di comando.
 Suitable for control panels.
 Пригоден для блоков управления



Manometri isometrici alla glicerina

Glycerin isometric pressure gauges

Изометрические глицериновые манометры



INOX Ø=63 mm
 F=G1/4"

Part No.	RANGE	Pack
8302200	0÷5/25 bar	5
8302201	0÷15/60 bar	5



INOX

Part No.	RANGE	Ø e mm	F	Pack
8302250	0÷5/25 bar	63	G 1/4	5
8302251	0÷15/60 bar	63	G 1/4	5
8302401	0÷15/60 bar	100	G 1/4	5



INOX

Part No.	RANGE	Ø e mm	F	Pack
8302300	0÷25 bar	100	G 1/2	5
8302400	0÷5/25 bar	100	G 1/4	5

* Adatto per scatole di comando.
 Suitable for control panels.
 Пригоден для блоков управления



Protezione in gomma per manometro

Protective rubber case

Резиновая защита для манометра



Part No.	Ø mm	Pack
P00600007	63	5

Sensore di pressione

Pressure sensor

Датчик давления



Part No.	L (m)	bar	mA	V dc	Pack
S02000026		20			
S02000010	5,0	50	4-20	12	1
S02000011		100			

Adatto per / Suitable to / Предусмотрен для

GS 250 GS 260 GS 220 GS 210 GS 200

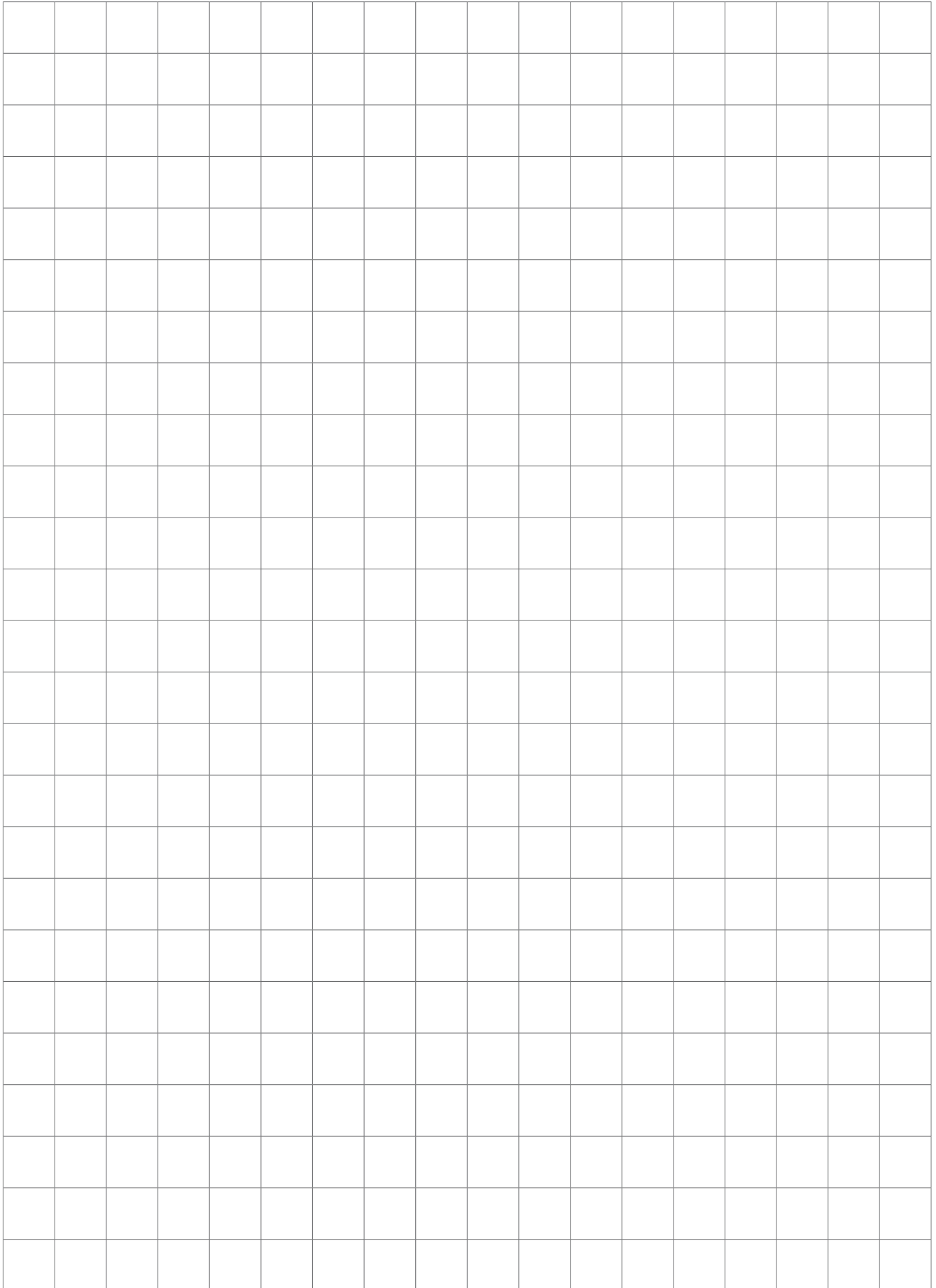

CONDIZIONI GENERALI DI VENDITA

CONDIZIONI GENERALI DI VENDITA

Art. 1 - Ambito di applicazione delle condizioni generali di vendita

1.1 Le presenti condizioni generali di vendita (di seguito le "Condizioni") si applicano a ogni contratto di vendita (di seguito il "Contratto") concluso da Tecomec (di seguito il "Venditore") ed avente ad oggetto i prodotti fabbricati e/o commercializzati dal Venditore (di seguito i "Prodotti").

1.2 Nonostante qualunque previsione contraria, anche se contenuta nelle eventuali condizioni generali dell'acquirente dei Prodotti (di seguito l'"Acquirente"), ogni offerta, conferma d'ordine e/o consegna da parte del Venditore si intende regolata dalle seguenti Condizioni, salvo patto contrario specificatamente accettato di volta in volta per iscritto dal Venditore.

Art. 2 - Conclusione ed entrata in vigore del Contratto

2.1 Il Contratto di vendita dei Prodotti si intende concluso (i) nel momento di emissione della relativa conferma d'ordine da parte del Venditore o, in mancanza di tale conferma, (ii) nel momento del ritiro dei Prodotti da parte dell'Acquirente.

2.2 Gli ordini dell'Acquirente saranno accettati dal Venditore solo a condizione che contengano le specifiche necessarie ad identificare i Prodotti ordinati, restando inteso che il Venditore si riserva la facoltà di accettare o rifiutare gli ordini dell'Acquirente a proprio insindacabile giudizio.

2.3 Eventuali annullamenti o modifiche dell'ordine da parte dell'Acquirente, successivi alla conclusione del Contratto di cui al precedente art. 2.1, non avranno effetto se non preventivamente autorizzati o successivamente accettati per iscritto dal Venditore (fermo restando che in nessun caso agenti, intermediari e/o collaboratori esterni del Venditore hanno il potere di accettare per conto di quest'ultimo gli ordini di acquisto dell'Acquirente e/o di formulare o accettare, in modo vincolante per il Venditore, proposte relative a sconti, abbuoni e/o condizioni derogative alle presenti Condizioni).

Art. 3 - Modalità di pagamento - Prezzi

3.1 Se non altrimenti convenuto per iscritto, ad ogni ordine si applicano i prezzi di listino praticati dal Venditore al momento della conferma d'ordine. I prezzi di eventuali Prodotti non riportati a listino saranno determinati di volta in volta dal Venditore.

3.2 I prezzi dei Prodotti si intendono al netto di IVA e di ogni altra spesa e/o onere accessorio (quali, in via esemplificativa e non limitativa, spese e/o commissioni bancarie, imballo speciale, assicurazione, trasporto), che devono intendersi quindi a carico dell'Acquirente.

Fermo quanto precede, le imposte, le tasse, i tributi, le licenze, le autorizzazioni, i permessi ed ogni e qualsivoglia costo o adempimento fiscale, doganale ed amministrativo da cui dipendano l'importazione e/o la rivendita dei Prodotti devono ritenersi ad esclusivo carico dell'Acquirente ovvero svolte dal Venditore sotto l'esclusiva responsabilità dell'Acquirente ed a rischio e spese di quest'ultimo.

3.3 Salvo diversa indicazione scritta nella conferma d'ordine, il pagamento del prezzo dei Prodotti sarà effettuato entro 30 (trenta) giorni dalla data di emissione della fattura. Per nessun motivo l'Acquirente potrà ritardare o sospendere i pagamenti del prezzo dei Prodotti. Qualora l'Acquirente non adempia regolarmente ai propri obblighi di pagamento del prezzo (compreso l'inadempimento dell'obbligo di versare gli eventuali anticipi), il Venditore avrà la facoltà di prorogare i termini di consegna pattuiti per un periodo corrispondente al ritardo dell'Acquirente e/o di risolvere il Contratto, ritenendo come penale le somme pagate dall'Acquirente, salva in ogni caso la risarcibilità del danno ulteriore.

Art. 4 - Termini di consegna ed imballo

4.1 Tutte le date indicate nelle conferme d'ordine come termini di consegna si intendono puramente indicative. Eventuali ritardi nella consegna non daranno diritto all'Acquirente alla risoluzione del Contratto, né al risarcimento dei danni di qualsiasi natura (fermo in ogni caso restando che l'Acquirente, mediante il ritiro della consegna tardiva, rinuncia a qualsivoglia pretesa in relazione al ritardo).

4.2 Salvo diverso accordo scritto tra le parti, la consegna dei Prodotti (così come il passaggio del relativo rischio) ha luogo secondo la formula "EX WORKS - franco fabbrica venditore" (Incoterms 2000); per effetto di quanto precede, il Venditore non stipulerà alcun contratto di spedizione o trasporto e non assicurerà i Prodotti oggetto di fornitura se non dietro espresso ordine dell'Acquirente, restando in ogni caso a carico di quest'ultimo tutti i conseguenti oneri e rischi.

4.3 L'Acquirente si impegna a ritirare i Prodotti immediatamente dopo aver ricevuto la comunicazione di merce pronta e comunque non oltre 8 (otto) giorni dalla data della predetta comunicazione. Il passaggio del rischio comincerà in ogni caso a decorrere dalla predetta data di avviso di merce pronta ovvero, solo in mancanza di questa, dalla data di consegna.

4.4 All'atto della consegna dei Prodotti, l'Acquirente è tenuto a controllarne numero e tipologia. Qualsiasi reclamo da parte dell'Acquirente in relazione alla quantità e alla qualità dei Prodotti consegnati deve pervenire in forma scritta al Venditore entro e non oltre 8 (otto) giorni dalla data di consegna dei Prodotti stessi.

4.5 I Prodotti sono consegnati dal Venditore all'Acquirente muniti di imballo adeguato. Resta inteso che il Venditore fornisce un imballo idoneo ad una permanenza delle merci in deposito/transito per un periodo non superiore a 180 (centottanta) giorni; qualora l'Acquirente comunichi con sufficiente anticipo che le merci potranno essere in deposito/transito per un periodo superiore a 180 (centottanta) giorni, il Venditore potrà fornire a spese dell'Acquirente un diverso imballo.

4.6 Con la consegna dei Prodotti, l'Acquirente si impegna a custodire con la dovuta diligenza i Prodotti ricevuti (conservandoli in luogo sicuro ed idoneo e facendo in modo che i Prodotti non siano sottoposti a condizioni climatiche e temperature inadeguate), posto che la proprietà dei Prodotti passerà all'Acquirente solo in seguito al saldo integrale del prezzo. In caso di mora dell'Acquirente nel pagamento del prezzo, il Venditore potrà, senza necessità di alcuna formalità, compresa la messa in mora, riprendere possesso di tutti i Prodotti oggetto di riservato dominio ovunque essi si trovino, nonché addebitare gli interessi di mora nella misura prevista dalla legge applicabile in materia (fermo restando il diritto del Venditore a ricorrere ad ogni ulteriore rimedio di legge circa il pregiudizio subito).

Art. 5 - Caratteristiche dei Prodotti; Modifiche ai Prodotti

5.1 Eventuali informazioni o dati sulle caratteristiche e/o specifiche tecniche dei Prodotti contenuti nei depliant, listini prezzi, cataloghi, o documenti similari sono puramente indicativi e non vincolanti, salvo espresso accordo scritto in tal senso tra le parti.

5.2 L'Acquirente non potrà effettuare, direttamente o indirettamente, alcuna modifica, cambiamento o qualsiasi altra alterazione dei Prodotti e supporterà ogni e più ampia responsabilità in relazione ai Prodotti, sia essa prevedibile o non prevedibile, derivante dal Contratto, da fatto illecito, da equità o altro, nel caso di suo inadempimento alle sopra citate obbligazioni.

5.3 Fermo restando quanto precede, il Venditore si riserva, a proprio insindacabile giudizio, il diritto di aggiornare, modificare e/o terminare la produzione di tutte o alcune tipologie di Prodotti.

A tale riguardo, l'Acquirente riconosce ed accetta altresì che i cambiamenti della tecnologia, delle condizioni di mercato o della politica delle vendite del Venditore consentono al Venditore stesso di modificare le specifiche di un Prodotto o di cessare la produzione e/o la vendita di uno o più tipologie di Prodotto. Resta comunque inteso che il Venditore non sarà in nessun caso ritenuto responsabile nei confronti dell'Acquirente e/o di terzi per gli eventuali danni, diretti o indiretti, che possano prodursi a seguito di una decisione del Venditore in tal senso.

Art. 6 - Responsabilità

6.1 Fermo restando le limitazioni della garanzia del Venditore di cui al successivo art. 7, in nessun caso la responsabilità complessiva del Venditore potrà eccedere il 7% (sette per cento) del prezzo pattuito in relazione ai Prodotti oggetto di contestazione.

6.2 L'Acquirente si impegna a prendere visione e conoscenza delle caratteristiche tecniche dei Prodotti, nonché delle istruzioni e delle avvertenze fornite in relazione all'uso che si può fare dei suddetti Prodotti ed al quale i medesimi Prodotti possono essere ragionevolmente destinati. Oltre a ciò, l'Acquirente si impegna a fare in modo che i Prodotti siano commercializzati unicamente a partire dal momento in cui i medesimi Prodotti rispettino tutte le leggi, i regolamenti e le altre normative (relative a imballi, istruzioni, informazioni e, più in generale, alla sicurezza delle cose e delle persone) previste dall'ordinamento del Paese in cui i Prodotti vengono commercializzati. Spetterà pertanto esclusivamente all'Acquirente - che si impegna pertanto a manlevare ed a tenere pienamente indenne il Venditore con riferimento a quanto previsto dal presente art. 6.2 - assicurare che l'utilizzo e la commercializzazione dei Prodotti risulti corretto e conforme alle suddette norme nonché alle esigenze della propria clientela ed alla buona tecnica.

Art. 7 - Garanzia

7.1 Il Venditore garantisce la qualità dei Prodotti per un periodo di 12 (dodici) mesi dalla consegna, salvo le tolleranze d'uso ed esclusi quei difetti che possano manifestarsi a causa del trasporto, di un uso improprio o di una inadeguata conservazione o manutenzione dei Prodotti. Dalla presente garanzia sono esclusi tutti gli ulteriori danni, ivi compresi quelli derivanti dalla mancata o ridotta produzione, nonché quelli indiretti e consequenziali, speciali, incidentali e/o di carattere sanzionatorio.

7.2 La garanzia è subordinata, a pena di decadenza, alla denuncia del vizio o della mancanza di qualità, comunicata in forma scritta al Venditore, entro 8 (otto) giorni dal momento in cui l'Acquirente ne ha fatto la scoperta, nonché all'espressa richiesta, sempre comunicata nelle forme indicate, al Venditore di effettuare un intervento in garanzia.

7.3 La garanzia consiste, a scelta del Venditore, nella riparazione o sostituzione, a cura e spese del Venditore, dei Prodotti che risultino rotti o difettosi per vizi di origine. Il Venditore provvede alla sostituzione ovvero alla riparazione nel più breve tempo possibile (da stabilire di volta in volta) ed ha facoltà di richiedere all'Acquirente la restituzione delle parti e/o dei Prodotti sostituiti.

7.4 Ogni diversa garanzia in relazione ai Prodotti, anche di legge, deve ritenersi esclusa e superata dalle presenti Condizioni.

Art. 8 - Resi

8.1 I Prodotti potranno essere resi dall'Acquirente al Venditore solo previa autorizzazione del Venditore stesso. Resta in ogni caso inteso che, in assenza del ritiro dei Prodotti, da parte dell'Acquirente, entro 6 (sei) mesi dalla data del relativo reso al Venditore (a prescindere dal fatto che si tratti di resi non autorizzati o di Prodotti fuori garanzia), il Venditore si riserva la facoltà di rottamare i Prodotti in questione e di addebitare all'Acquirente il costo di tale operazione, fermo restando in ogni caso il diritto del Venditore al rimborso del costo del deposito dei Prodotti resi.

Art. 9 - Forza maggiore

9.1 Il Venditore non è responsabile nei confronti dell'Acquirente di alcun inadempimento, compresa la mancata o ritardata consegna, causato da accadimenti al di fuori del proprio ragionevole controllo o comunque riconducibili a caso fortuito o a forza maggiore, quali, a titolo meramente indicativo, mancata o ritardata consegna dei materiali di lavorazione da parte dei fornitori, scioperi ed altre azioni sindacali, sospensione dell'energia elettrica o difficoltà nei trasporti.

9.2 Al verificarsi di un evento di forza maggiore gli obblighi delle parti che non possano essere adempiuti per tale causa sono automaticamente prorogati, senza penalità a carico, per un periodo corrispondente alla durata dello stato di forza maggiore; quanto precede, ad eccezione dell'obbligo dell'Acquirente di corrispondere le somme dovute a titolo di pagamento del prezzo, per il quale restano in ogni caso ferme le scadenze precedentemente pattuite.

Art. 10 - Legge applicabile e foro competente

10.1 Le presenti Condizioni e tutti i contratti di vendita di cui siano parte il Venditore e l'Acquirente sono esclusivamente regolati dalla legge italiana (con conseguente applicazione delle disposizioni della Convenzione di Vienna dell'11 aprile 1980 sui contratti di vendita internazionale di beni mobili, nella misura in cui non derogate dalle clausole del presente Contratto).

10.2 Foro competente in via esclusiva per tutte le controversie relative alla sottoscrizione, all'interpretazione, all'esecuzione ed allo scioglimento per qualsivoglia motivo delle presenti Condizioni e di tutti i contratti di vendita di cui siano parte il Venditore e l'Acquirente è quello della sede legale del Venditore, salva la facoltà per quest'ultimo di convenire l'Acquirente davanti ad ogni Foro avente giurisdizione nei confronti dell'Acquirente stesso.

GENERAL CONDITIONS OF SALE

GENERAL CONDITIONS OF SALE

Art. 1 - Scope of application of the General Conditions of Sale

1.1 - These general conditions of sale (hereinafter the "Conditions") shall apply to every contract of sale (hereinafter the "Contract") entered into by Tecomec (hereinafter the "Seller") which concerns the products manufactured and/or marketed by the Seller (hereinafter the "Products").

1.2 - Notwithstanding any provision to the contrary and even if any such provision may be contained in any possible general conditions of the buyer of the Products (hereinafter, the "Buyer"), the Conditions shall apply to any offer, any order confirmation and any delivery effected by the Seller, except as expressly provided from time to time in a written document signed by the Seller.

Art. 2 - Conclusion and effective date of each Contract

2.1 - The Contract of sale of the Products shall be deemed to enter into force (i) at such time as the Seller issues the relevant order confirmation, or in absence of such an order confirmation, (ii) at such time as the Buyer collects the Products.

2.2 - The Buyer's orders will be accepted by the Seller only if said orders contain the specifications which are necessary for the purpose of identifying the Products ordered, it being understood that the Seller shall be entitled, at its sole discretion, to accept or refuse the Buyer's orders.

2.3 - Any possible cancellation of or amendment to any order by the Buyer shall not be effective unless previously authorised or subsequently accepted in writing by the Seller (it being in any event understood that the Seller's commercial agents, intermediaries and/or external consultants shall not have the power to accept the Buyer's orders on behalf of the Seller and/or to formulate or accept any proposal, in such a way as to bind the Seller, relating to discounts, sales allowances and/or variations to the Conditions.

Art. 3 - Terms of payment and Prices

3.1 - Unless otherwise agreed in writing, the Seller's price list which is in force as of the date of the order confirmation shall apply to any order made by the Buyer. The prices of any Products not appearing on the price list shall be determined by the Seller on a case by case basis.

3.2 - The prices of the Products shall be deemed exclusive of VAT and of any other incidental expense and/or cost (including, but not limited to, bank commissions or expenses, special packaging, insurance, transport), which shall be borne by the Buyer.

Without prejudice to the above, any and all taxes, duties, levies, licences, authorisations, permits and any and all tax and administrative or customs formalities or costs relating to the importation and/or re-sale of the Products shall be borne and carried out exclusively by the Buyer or, alternatively, they may be carried out by the Seller at the Buyer's sole risk, expense and responsibility.

3.3 - Unless otherwise indicated in the order confirmation, payment of the price of the Products will be effected within 30 (thirty) days following the date of issue of the relevant invoice.

Under no circumstances shall the Buyer be entitled to suspend or delay payment of the Products. In the event that the Buyer fails to fulfil its obligations to pay the price (including the obligation to make any possible advance payments), the Seller shall be entitled to postpone the delivery of the Products for a period corresponding to the length of the delay on the part of the Buyer and/or to terminate the Contract, retaining the sums received from the Buyer by way of liquidated damages, without prejudice to the Seller's rights to claim compensation for any further damages suffered.

Art. 4 - Terms of delivery and packaging

4.1 - All delivery dates as well as delivery terms given in the order confirmation shall be deemed to be indicative only. In the event of possible late delivery, the Buyer shall not be entitled to terminate the Contract or claim compensation for damages of whatever nature (it being in any event understood that by collecting any Products which may have been delivered late, the Buyer waives any and all rights relating to said delay).

4.2 - Unless otherwise agreed in writing between the parties, the delivery of the Products (and the relating transfer of risk) will be effected "EX WORKS" (Incoterms 2000); in the light of the above, the Seller shall not enter into any shipment or transportation agreement and shall not insure the Products to be supplied, unless the Buyer should so expressly instruct the Seller in writing; it being in any event understood that any and all risks and expenses in relation thereto shall be borne exclusively by the Buyer.

4.3 - The Buyer agrees to collect the Products as soon as it receives notice that the Products are ready and at its disposal and, in any event, within 8 (eight) days of the date of said notice. In any event, the transfer of risk and the payment terms shall start running as of the date of the notice that the Products are ready or, in the absence thereof, as of the date of delivery.

4.4 - At the time of delivery of the Products the Buyer shall check the quantity and the specifications of the Products delivered. Any claim by the Buyer in respect of the quantity or the quality of the delivered Products shall be communicated in writing to the Seller within no more than 8 (eight) days following the date of delivery of the Products.

4.5 - The Products shall be delivered by the Seller to the Buyer with appropriate packaging; it being understood that the packaging provided by the Seller is suitable for a period of storage/transit not exceeding 180 (one hundred and eighty) days. Provided that the Buyer advises the Seller sufficiently in advance that the goods may be in storage/transit for a period exceeding 180 (one hundred and eighty) days, then the Seller may supply the Buyer, at the latter's expense, with different packaging.

4.6 - From such time as the Products are delivered, the Buyer undertakes to look after the Products with the requisite care (keeping them in a safe and appropriate place and in such a way that they are not subjected to inappropriate climatic conditions and temperatures), given that the ownership of the Products shall pass to the Buyer only upon payment in full of the sale price of the Products. In the event that the Buyer fails to pay the price, the Seller shall be entitled, without any formalities, including sending a notice of default, to repossess all of the Products with respect to which title has not yet passed to the Buyer, wherever said Products may be; in addition, the Seller shall be entitled to charge interest on arrears at the rate provided by the applicable law (without prejudice to the Seller's right to seek any other judicial remedies available to it in respect of the damages suffered).

Art. 5 - Characteristics of the Products; Modifications to the Products

5.1 - Any possible information or data relating to the characteristics and/or to the technical specifications of the Products that may be included in brochures, price lists, catalogues, or similar documents are indicative only and not binding, unless otherwise agreed in writing by the parties.

5.2 - The Buyer shall be prohibited from making, directly or indirectly, any changes, modifications or other alterations whatsoever to the Products and should the Buyer breach such obligations, it shall bear any and all liability in respect of the Products, be it foreseeable or unforeseeable, arising out of the Contract, any unlawful act, in equity or otherwise.

5.3 Without prejudice to the above terms, the Seller reserves the right to update, modify or terminate the production of all or any of the Products as determined by the Seller at its sole discretion.

In this regard, the Buyer acknowledges and agrees that changes in technology or in market conditions or in the Seller's sales and marketing policy may prompt the Seller to modify the Product specifications or to cease to manufacture or sell one or more types of the Products and that the Seller shall not be in any way liable to the Buyer for any possible damages, be they direct or indirect, which may be suffered by the Buyer as a result of such decision by the Seller.

Art. 6 - Liability

6.1 - Without prejudice to the limitations of the warranty as per Art. 7 below, the Seller's total liability may not in any event exceed an amount equal to 7% (seven percent) of the price agreed for the Products in respect of which the claim occurs.

6.2 - The Buyer undertakes to read and make itself acquainted with the specifications of the Products and the instructions and warnings supplied in relation to the use that may be made of said Products and the use for which the Products may be reasonably intended. In addition, the Buyer shall ensure that the Products will only be marketed as of such time as they comply with all laws, regulations and other rules (relating to packaging, instructions, information, and in general, to the safety of persons and goods) provided by the country in which the Products will be marketed. The Buyer shall be solely responsible for ensuring that the use and marketing of the Products are correct and in compliance with the above-mentioned regulations and laws, in addition to the requirements of the Buyer's customers and good technique and the Buyer shall indemnify and hold the Seller harmless with regard to the terms of this Art. 6.2.

Art. 7 - Warranty

7.1 - The Seller warrants the quality of the Products for a period of 12 (twelve) months following the date of delivery, subject to the customary tolerances and excluding those defects which may arise due to transportation, improper use or inappropriate storage or maintenance of the Products. Any other damages, including any possible damages resulting from the lack of or a reduction in production, in addition to any indirect, consequential, special or incidental or damages of a punitive nature, are expressly excluded from the warranty.

7.2 - The warranty shall be subject to the Buyer duly informing the Seller in writing, within 8 (eight) days following the discovery thereof, of the particular defect or lack of quality, failing which the Buyer shall lose its rights under the warranty in respect thereof, and shall also be subject to the Buyer making an express written request to the Seller to provide assistance under the warranty.

7.3 - The warranty consists in either the repair or replacement, at the Seller's sole discretion and at its expense, of the Products which may prove to be broken or defective due to manufacturing defects. The Seller shall replace or repair the defective parts in the shortest time possible (which shall be calculated on a case by case basis) and the Seller shall have the right to request the Buyer to return the defective parts and/or the Products which have been replaced.

7.4 - Any other warranty relating to the Products, including without limitation, any warranties provided by law, shall be deemed excluded and superseded by these Conditions.

Art. 8 - Returned Products

8.1 - The Products may be returned by the Buyer to the Seller only if the Seller has given its prior written authorisation in relation thereto. It is in any event understood that if the Buyer does not collect the Products within a period of 6 (six) months after they have been returned to the Seller (regardless of whether the return is unauthorised or in relation to Products which are no longer under warranty), the Seller shall be entitled to scrap said Products and to charge the Buyer the relevant costs, without prejudice to the Seller's right to be reimbursed by the Buyer for the costs relating to the storage of the returned Products.

Art. 9 - Force Majeure

9.1 - The Seller shall not be liable vis-à-vis the Buyer for any failure to perform, including late delivery or failure to deliver, which is caused by occurrences beyond the Seller's reasonable control or in any case caused by an event of force majeure, including, but not limited to, late delivery or non-delivery of manufacturing materials by suppliers, strikes and other trade union actions, suspension of electrical energy or difficulties in transportation.

9.2 - Upon the occurrence of any event of force majeure which is such as to prevent either party hereto from fulfilling its obligations hereunder, then the time for the party so affected to fulfil its obligations shall be automatically extended for a period corresponding to the duration of the event of force majeure, save for the Buyer's obligation to pay the amounts due by way of the price, in respect of which the contractually agreed due dates shall remain in full force and effect.

Art. 10 - Applicable Law and jurisdiction

10.1 - These Conditions and all contracts of sale to which the Seller and the Buyer are a party shall be exclusively governed by Italian law (including the provisions of the Vienna Convention 1980, relating to contracts for the international sale of goods, which are not derogated by these Conditions).

10.2 - Any and all disputes arising out of or relating to the signing, interpretation, execution and termination for any reason whatever of these Conditions and of the contracts of sale to which the Seller and the Buyer are a party, shall be settled exclusively by the courts of competent jurisdiction for the place in which the Seller's registered office is located. Notwithstanding the foregoing, the Seller may bring an action against the Buyer before any court having jurisdiction over the Buyer.

www.geoline.it

Il presente documento annulla e sostituisce tutti i precedenti.

Le informazioni contenute nel presente documento sono atte alla semplice individuazione del prodotto.

L'utilizzatore deve scegliere ed installare i prodotti in base alle leggi applicabili, alle norme e ai criteri essenziali di sicurezza in vigore.

I prodotti nel presente documento sono ad uso esclusivo di operatori professionali che abbiano le capacità necessarie per operare la scelta più opportuna del prodotto e per garantirne il suo utilizzo a regola d'arte.

Foto, dimensioni, caratteristiche e codifiche possono essere soggette a modifiche e variazioni senza preavviso. La documentazione, disponibile presso l'Ufficio Tecnico, garantisce tutti gli aggiornamenti.

Per informazioni più dettagliate riguardo alle caratteristiche e alle applicazioni dei prodotti richiamati a catalogo, si prega di contattare l'Ufficio Tecnico e/o la nostra Assistenza Tecnica.

This catalogue replaces any previous ones.

The information included in this catalogue simply intend to identify the product.

The user must choose and install the products according to the applicable laws and current safety regulation.

The products included in this catalogue are for the exclusive use of professional workers able to choose the right product, granting its better employment.

Pictures, dimensions, features and coding can be changed or modified without prior notice. The documentation available by our Technical Department offers the appropriate updating.

For more detailed information concerning features and use of the products included in this catalogue, please contact our Technical Department.

TeeJet®, FullJet®, ConeJet®, Turbo FloodJet™, TwinJet®, - sono marchi registrati dalla Spraying System company, Wheaton, IL, USA.

Teflon®, Viton®, Delrin®, - sono marchi registrati dalla E.I. DuPont de Nemours and Company, USA.

Albuz®, - è un marchio registrato dalla Norton Desmarquest, FRANCE.

Arag®, - è un marchio registrato della ARAG Srl - Italia.

LECHLER® - è un marchio registrato della **Lechler GmbH**
Agrardüsen - Agricultural Nozzles, Germania.

TRIMBLE® - è un marchio registrato di **Trimble Inc.**

TeeJet®, FullJet®, ConeJet®, Turbo FloodJet™, TwinJet®, - are registered trademark of Spraying System company, Wheaton, IL, USA.

Teflon®, Viton®, Delrin®, - are registered trademark of E.I. DuPont de Nemours and Company, USA.

Albuz®, - is a registered trademark of Norton Desmarquest, FRANCE.

Arag®, - is a registered trademark of ARAG Srl - Italy.

LECHLER® - is a registered trademark of **Lechler GmbH**
Agrardüsen - Agricultural Nozzles, Germany.

TRIMBLE® - is a registered trademark of **Trimble Inc.**



Sono marchi di proprietà Tecomec S.r.l.
Are Tecomec S.r.l. owned brands

FILIALE TECOMECC S.R.L.

Spraycom Comércio de Peças para Agricultura S/A
Av. Said Tuma, 600 – Distrito Indl. José Antonio Boso
15803-150 – Catanduva SP
Brasile

TECOMECC S.R.L. SUBSIDIARY

Spraycom Comércio de Peças para Agricultura S/A
Av. Said Tuma, 600 – Distrito Indl. José Antonio Boso
15803-150 – Catanduva SP
Brazil



Questo catalogo è stato stampato con inchiostri vegetali e matrici ecologiche prodotte senza bagni chimici.
This catalogue has been printed using vegetal inks and no process plates.

Questo catalogo è stampato su carta certificata FSC®.
This catalog is printed on FSC® certified paper.





TECOMEC S.r.l.
STRADA DELLA MIRANDOLA, 11
42124 REGGIO EMILIA - ITALY
TEL +39 0522 959001
FAX +39 0522 959060
SALES_DEPT@GEOLINE.IT
WWW.GEOLINE.IT - WWW.TECOMEC.COM



CERTIFIED QUALITY SYSTEM
UNI EN ISO 9001



www.geoline.it

